

TCE / TCX / TCN / TXR Molded Series

Radial Molded Capacitors

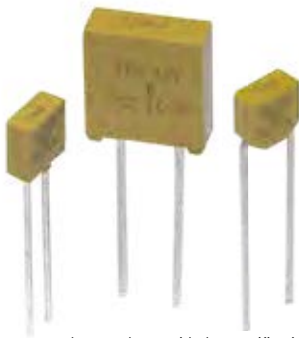

In accordance with the specifications of CECC 30700 and NF C 83132 standards

FEATURES

- Radial molded capacitors
- NPO, BX, 2C1, X7R dielectrics
- Capacitance range: 0.5pF to 4.7μF
- RoHS and Non RoHS compliant capacitors available

PHYSICAL CHARACTERISTICS

CONSTRUCTION

Leaded MLCC capacitors for through-hole mounting:
Epoxy molded capacitors

MARKING

Capacitance, tolerance, voltage, dielectric, date code.

TCN 50/60 R : Enhanced reliability types of TCN 50 A and TCN 60 A.

ELECTRICAL SPECIFICATIONS

Description	NPO	BX	2C1	X7R
Dielectric code	CE	CX	CN	XR
Operating temperature	-55°C to +125°C			
Climatic category	55 / 125 / 56			
Rated voltage (U _{RC})	25V _{DC} to 500V _{DC}			
Max. ΔC/°C over temperature range without DC voltage applied	NA	± 15%	± 20%	± 15%
Maximum ΔC/°C over temperature range with rated voltage applied	NA	+15% -25%	+20% -30%	NA
Temperature coefficient with or without DC voltage applied	(0 ± 30)ppm/°C	NA	NA	NA
Dielectric withstanding voltage	2.5 U _{RC}			
Capacitance	at 1MHz for C ≤ 1,000pF at 1kHz for C > 1,000pF		at 1MHz for C ≤ 100pF at 1kHz for C > 100pF	
Dissipation factor at 25°C	≤ 0.015 (150/°C + 7)% at 1MHz for C ≤ 50pF ≤ 0.15% at 1MHz for 50pF < C ≤ 1,000pF ≤ 0.15% at 1kHz for C > 1,000pF		≤ 2.5% at 1MHz for C ≤ 100pF ≤ 2.5% at 1kHz for C > 100pF	
Insulation resistance at 25°C	≥ 100,000 MΩ for C ≤ 10nF ≥ 1,000 MΩ.μF for C > 10nF			
Aging	None		≤ 2.5% per decade hour	

HOW TO ORDER

T	CE	61	A	W	F	6.8nF	10%	25V	B	-
Series	Dielectric	Size	Bismuth	RoHS compliant	Quality level	Capacitance	Tolerance	Rated voltage	Packaging	Reliability level
T = Radial leaded, molded capacitor	CE = NPO CX = BX CN = 2C1 XR = X7R	50 60 61 61N 62 62N 63 64	- = For all models A = Bismuth free for 50/60 sizes only (tg δ at -55°C ≤ 350.10 ⁻⁴)	- = No RoHS W = RoHS compliant	- = standard quality level F = Hi-Rel quality: screening in accordance with Exxelia specification	Capacitance value in clear	NPO: cap. value ≤ 12pF ± 0.25pF cap. value ≤ 8.2pF ± 0.5pF ± 1pF cap. value > 22pF ± 1% cap. value > 12pF ± 2% cap. value > 8.2pF ± 5% ± 10% cap. value > 3.9pF ± 20% Available for BX, 2C1 and X7R: ± 5% ± 10% ± 20%	25V 50V 100V 200V 500V Intermediary and higher voltages available on request.	- = Exxelia packaging Available for quantity ≥ 500: B = reel	For F parts only. Acc. to Exxelia spec. - T5 T6 See page 15

Radial Molded Capacitors

TCE / TCX / TCN / TXR Molded Series

DIMENSIONS in inches (mm)

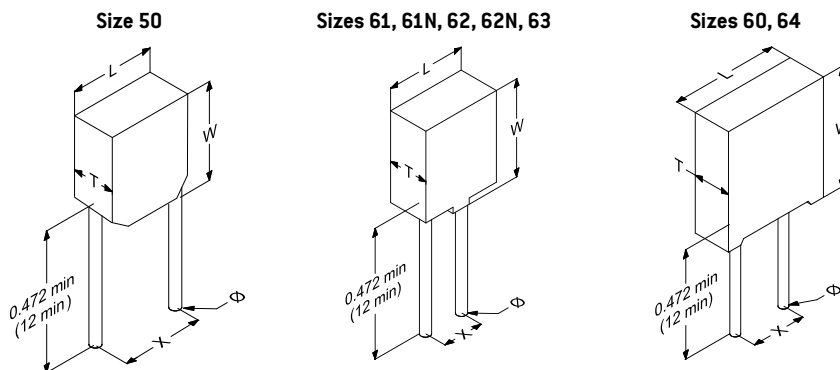

STANDARD RATINGS

Size	61				61N				62				62N				63				64								
Dimensions inches (mm)	L	0.138 ± 0.02 (3.5 ± 0.5)								0.197 ± 0.02 (5 ± 0.5)								0.295 ± 0.02 (7.5 ± 0.5)								0.394 ± 0.02 (10 ± 0.5)			
	W	0.178 max (4.5 max)								0.237 max (6 max)								0.335 max (8.5 max)								0.434 max (11 max)			
	T	0.098 ± 0.008 (2.5 ± 0.2)								0.098 (2.5 ± 0.2)								0.098 (2.5 ± 0.2)								0.138 (3.5)			
	X	0.1 ± 0.008 (2.54 ± 0.2)				0.2 ± 0.008 (5.08 ± 0.2)				0.1 ± 0.008 (2.54 ± 0.2)				0.2 ± 0.008 (5.08 ± 0.2)				0.2 ± 0.008 (5.08 ± 0.2)				0.2 ± 0.008 (5.08 ± 0.2)							
	Ø ± 10%	0.024 (0.6)								0.024 (0.6)								0.024 (0.6)				0.031 (0.8)							
Dielectric	NPO	BX	2C1	X7R	NPO	BX	2C1	X7R	NPO	BX	2C1	X7R	NPO	BX	2C1	X7R	NPO	BX	2C1	X7R	NPO	BX	2C1	X7R					
Dielectric code	CE	CX	CN	XR	CE	CX	CN	XR	CE	CX	CN	XR	CE	CX	CN	XR	CE	CX	CN	XR	CE	CX	CN	XR					
Min. Cap. value	1pF	27pF				1pF	33pF				4.7pF	330pF				220pF	4.7nF												
Rated voltage (U _{RC})	25V	6.8nF	220nF	220nF	220nF	33nF	820nF	1µF	1µF	68nF	1.8µF	1.8µF	1.8µF	180nF	4.7µF	4.7µF	4.7µF												
	50V	3.3nF	56nF	82nF	100nF	15nF	220nF	390nF	470nF	47nF	1µF	1.2µF	1.2µF	120nF	2.7µF	3.9µF	3.9µF												
	63V	2.7nF	33nF	47nF	68nF	12nF	150nF	220nF	330nF	39nF	560nF	1µF	1µF	100nF	1.8µF	2.7µF	2.7µF												
	100V	1.5nF	12nF	22nF	39nF	6.8nF	56nF	120nF	180nF	18nF	220nF	470nF	680nF	56nF	680nF	1.2µF	1.8µF												
	200V	390pF	3.3nF	5.6nF	10nF	1.8nF	15nF	27nF	47nF	6.8nF	56nF	100nF	180nF	22nF	180nF	330nF	560nF												
	250V	270pF	1.8nF	3.9nF	6.8nF	1.2nF	8.2nF	18nF	27nF	4.7nF	33nF	68nF	120nF	15nF	100nF	220nF	330nF												
	500V	100pF	-	560pF	1.2nF	470pF	-	3.3nF	4.7nF	2.2nF	-	10nF	22nF	6.8nF	-	47nF	82nF												

Size	50				60								
Dimensions inches (mm)	L	0.197 ± 0.02 (5 ± 0.5)								0.295 ± 0.02 (7.5 ± 0.5)			
	W	0.197 ± 0.008 (5 ± 0.2)								0.295 ± 0.008 (7.5 ± 0.2)			
	T	0.098 max. (2.5 max.)								0.098 max. (2.5 max.)			
	X	0.2 ± 0.008 (5.08 ± 0.2)								0.2 ± 0.008 (5.08 ± 0.2)			
	Ø ± 10%	0.024 (0.6)								0.024 (0.6)			
Dielectric	NPO	BX	2C1	X7R	NPO	BX	2C1	X7R	NPO	BX	2C1	X7R	
Dielectric code	CE	CX	CN	XR	CE	CX	CN	XR	CE	CX	CN	XR	
Min. Cap. value	1pF	10pF				4.7pF	330pF						
Rated voltage (U _{RC})	25V	27nF	820nF	820nF	820nF	56nF	1.5µF	1.5µF	1.5µF				
	50V	12nF	220nF	270nF	390nF	39nF	1µF	1µF	1µF				
	63V	10nF	120nF	180nF	270nF	27nF	470nF	1µF	820nF				
	100V	5.6nF	47nF	100nF	150nF	15nF	180nF	390nF	560nF				
	200V	1.5nF	12nF	22nF	39nF	5.6nF	39nF	82nF	150nF				
	250V	1.2nF	6.8nF	15nF	27nF	3.9nF	27nF	56nF	100nF				
	500V	390pF	-	1.8nF	4.7nF	1.5nF	-	8.2nF	15nF				

Available capacitance values:

NPO: E6, E12, E24, E48, E96 (see page 14). Specific values upon request.

X7R: E6, E12, E24 (see page 14). Specific values upon request.

The above table defines the standard products, other components may be built upon request.

STANDARD

General Information NPO/COG (Class 1)

COMPOSITION

NPO capacitors are produced by using a dielectric made of titanium dioxide (TiO_2) modified by magnesium oxide MgO (white ceramics) or a rare earth oxide, e.g. Nd_2O_3 (other NPO ceramics).

As a consequence, these ceramics are non ferro-electric materials with a low dielectric constant ($\epsilon_r \leq 110$).

Other additives are used to dope the dielectric constant up to 300. Though derogating from CG class, doped dielectric constant features a linear temperature drift and a matchless stability compared with class 2 ceramics.

The wide range of possible NPO dielectric compositions enables to use the material best suited to the application :

- standard applications,
- high voltage,
- high temperature,
- microwave,
- power capacitors.

«Temperature coefficient» compositions are particularly suitable for impedance matching. These ceramics usually enable to achieve temperature coefficients from 0 to $-1\,000$ ppm/°C. For specific requirements, other coefficients can be achieved (e.g. $-3\,300$ ppm/°C).

STABILITY

As ϵ_r is low, these dielectrics are extremely stable with only minor changes under such stresses as :

- temperature,
- voltage,
- frequency.

In addition, they are not affected by piezo-electric phenomena and their dielectric absorption coefficients are low and even non measurable for dielectrics with the lowest constants.

MECHANICAL PROPERTIES

Class 1 ceramics are the perfect match for metallic electrodes made of Pd or Ag-Pd alloy and have a high hardness and mechanical toughness making them resistant to thermal shocks (wave soldering for instance) and to thermal cycling after mounting on substrates having an expansion coefficient close to the capacitor one.

Ceramic chips meet CECC 32100 and NF C 93133 standards.

CLIMATIC CATEGORIES

Climatic categories are identified by three-digit codes as per NF C 20700 standard. Coding method is described in table 6.

e.g. : $-55^\circ C + 125^\circ C / 56$ days category is identified by code 434.

TEMPERATURE COEFFICIENT

Temperature coefficient $k\theta$ (ppm/°C)		
$k\theta$	Tolerances	Code letter
+ 100	± 30	AG
0	± 30	CG
- 33	± 30	HG
- 75	± 30	LG
- 150	± 30	PG
- 220	± 30	RG
- 330	± 60	SH
- 470	± 60	TH
- 750	± 120	UJ
- 1 000	± 250	QK

General Information NPO/COG (Class 1)

STANDARD

IMPEDANCE VERSUS FREQUENCY

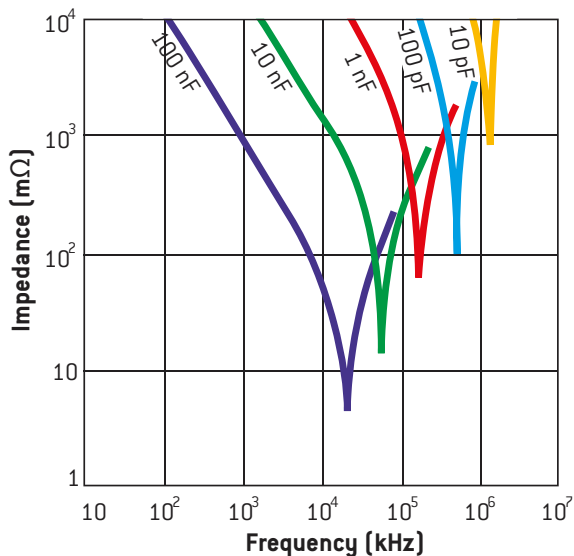

DISSIPATION FACTOR VERSUS FREQUENCY

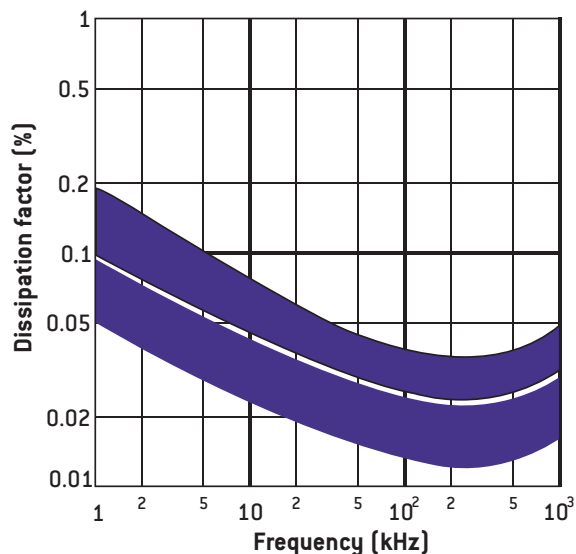

CAPACITANCE CHANGE VERSUS TEMPERATURE

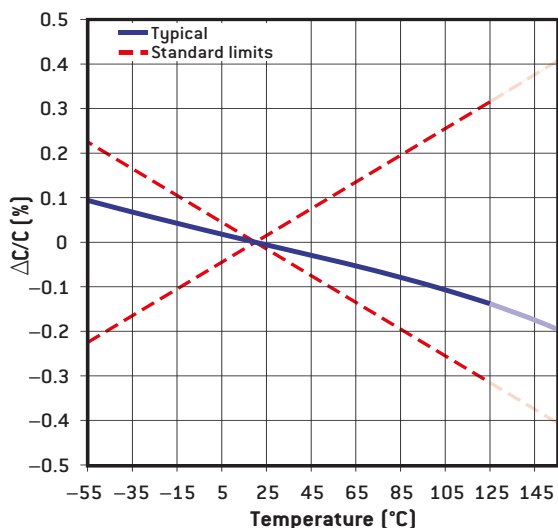

IR VERSUS TEMPERATURE

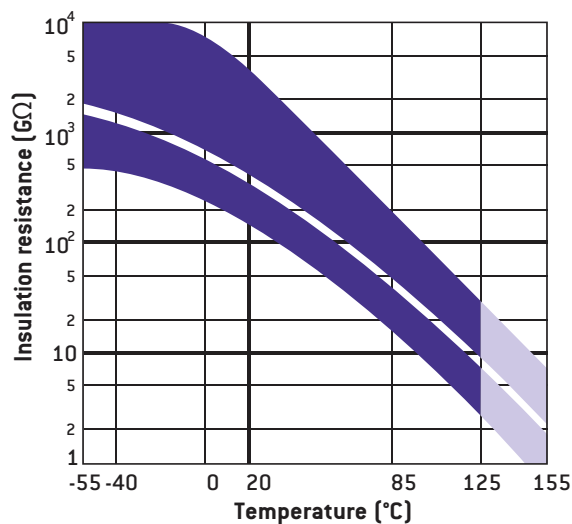

DISSIPATION FACTOR VERSUS TEMPERATURE

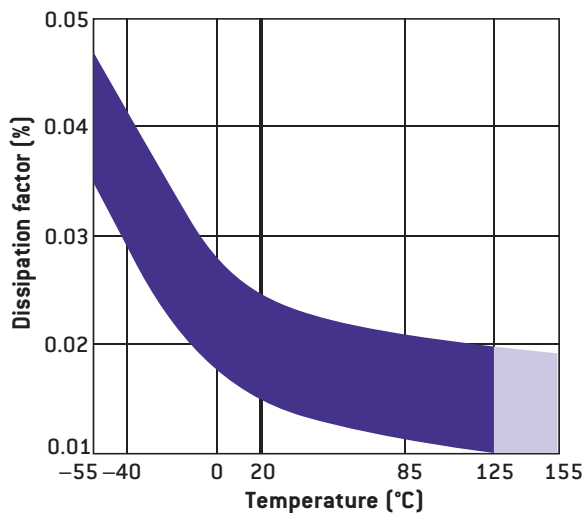

TYPICAL FAILURE RATE VERSUS TEMPERATURE

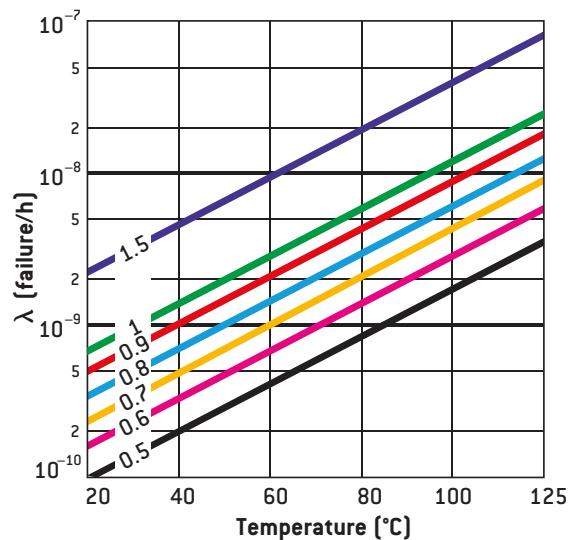

General Information X7R (Class 2)

COMPOSITION

Class 2 capacitors are produced by using a dielectric made of barium titanate (Ba Ti O₃). By nature, the dielectric is a ferroelectric compound with a high dielectric constant usually varying :

- from 1 000 to 5 000 - typical of capacitors meeting 2C1 type specifications (BX, X7R),
- from 5 000 to 15 000 - typical of capacitors meeting Z5U or Y5V type specifications.

Depending on whether the dielectric contains a flux additive, mainly bismuth or boron, electrodes are made of Ag-Pd alloys with high silver content or high palladium content, even pure palladium in some cases.

STABILITY

As the dielectric is a ferro-electric material, class 2 capacitors present significant variations under such stresses as :

- temperature,
- voltage,
- frequency.

In addition, the dielectric absorption coefficient can reach a few % and piezo-electric phenomena can affect the dielectric at critical frequencies (full information and specific documents available on request).

MECHANICAL PROPERTIES

Class 2 dielectrics are hard materials and are sensitive to thermo-mechanical stress. Stress should be limited when mounting and adequate substrates with an adapted expansion coefficient used.

BISMUTH OR BISMUTH FREE DIELECTRICS

Class 2 capacitors are made of ceramics capable to embed a flux element (e.g. bismuth or boron salt). Their eventual use will affect the choice of electrode alloys firing temperature used. Capacitor behavior under such constraints as temperature, voltage, frequency and even reliability, in some applications (further information available on request), is also different.

That is why French and European standard authorities have decided to differentiate bismuth from bismuth free ceramics by measuring tangent δ at -55°C . Tangent $\text{Tg } \delta (-55^{\circ}\text{C}) 350.10^{-4}$ in flux free dielectrics.

Flux free dielectrics are identified by suffix «A» after capacitor type (e.g. CNC2A).

CAPACITANCE/TEMPERATURE RELATIONSHIP

Capacitance variations are defined within a specified temperature range, +20°C being the reference temperature. This characteristic is expressed by associating the temperature range and capacitance stability.

Stability category Code letter	Max. capacitance variation (%) with reference to capacitance at 20°C	
	Without voltage	At rated DC voltage (U _{DC})
B	± 10	+ 10– 15
C	± 20	+ 20 – 30
D	+ 20 – 30	+ 20 – 40
E	+ 20 – 55	+ 20 – 65
R	+ 15 – 15	Not applicable
X	+ 15 – 15	+ 15 – 25

Temperature category	
Code	Temperature range
1	– 55°C + 125°C
2	– 55°C + 85°C
4	– 25°C + 85°C

CAPACITANCE CHANGE VERSUS FREQUENCY

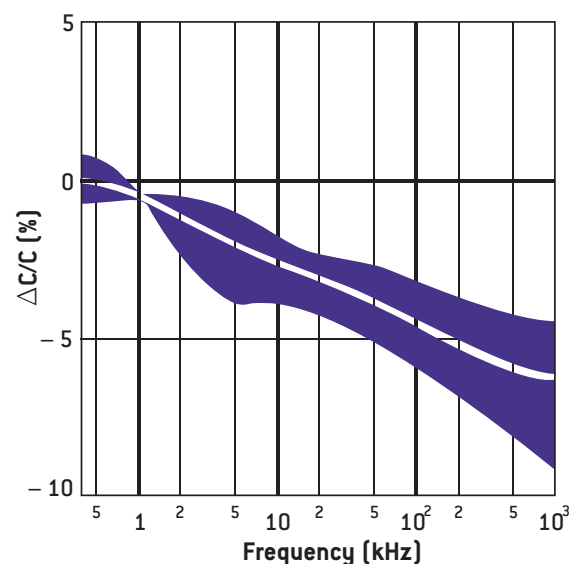

General Information X7R (Class 2)

STANDARD

IMPEDANCE VERSUS FREQUENCY

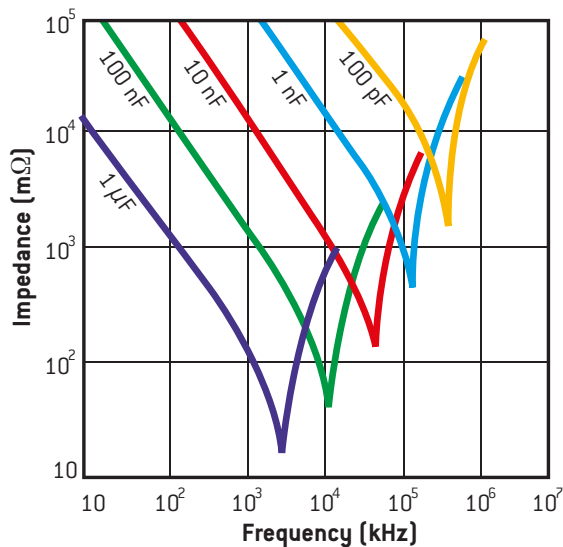

DISSIPATION FACTOR VERSUS FREQUENCY

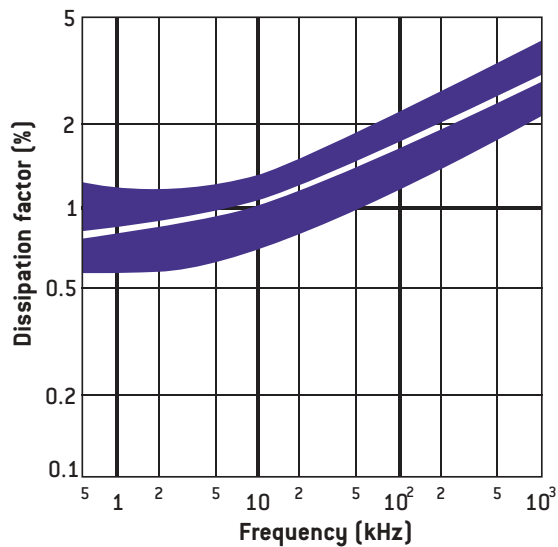

DISSIPATION FACTOR VERSUS TEMPERATURE

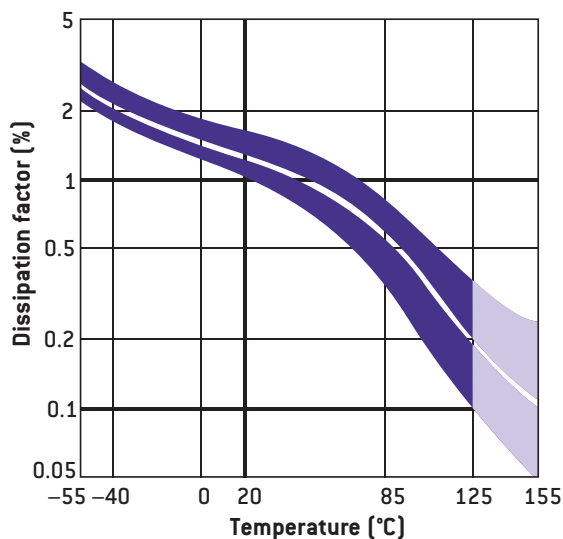

CAPACITANCE CHANGE VERSUS TEMPERATURE

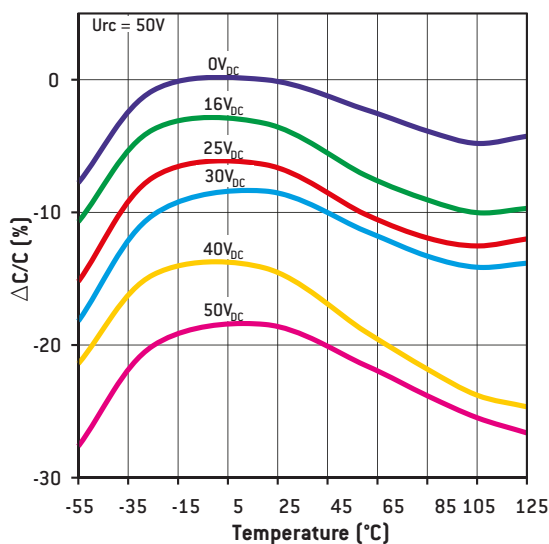

IR VERSUS TEMPERATURE

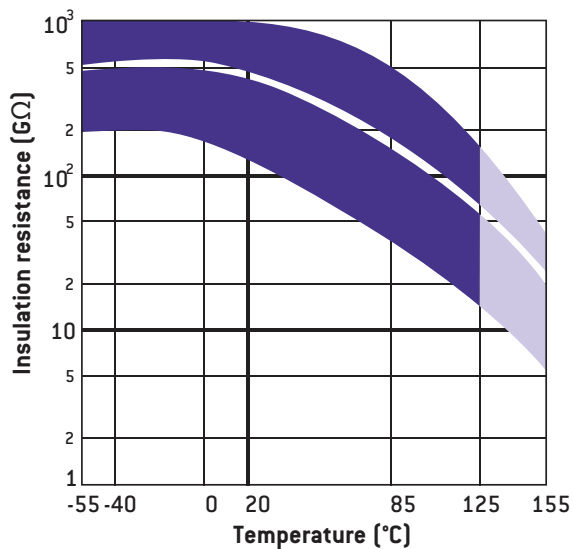

TYPICAL FAILURE RATE VERSUS TEMPERATURE

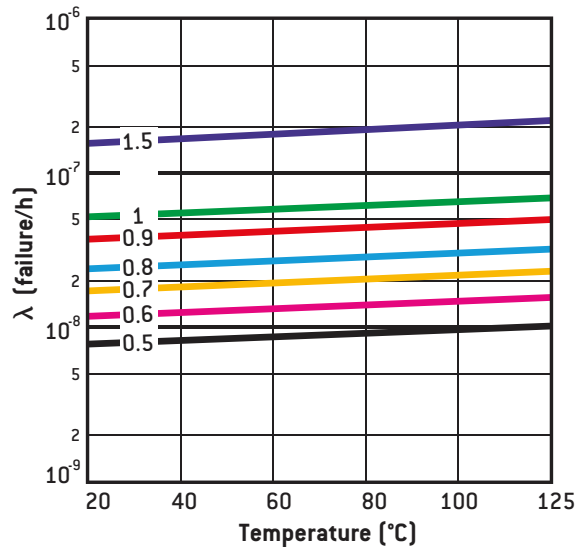

General Information

MATERIALS EXPERT

For 50 years and as a market leader, EXXELIA's comprehensive knowledge of the materials properties and performances have enabled us to design capacitors in Porcelain, NPO, BX, 2C1, BP, X7R and –2200ppm/°C ceramics.

CUSTOM DESIGNS

Our catalog products don't meet your application?

Based on the valuable experience accumulated over the design of 2,000+ specific ceramic capacitors, you can trust EXXELIA to define a qualitative custom solution in a time effective manner.

NO OBSOLESCENCE

Choosing a standard or custom EXXELIA product means you won't have to worry about obsolescence.

TYPICAL APPLICATIONS

- Aerospace & Defense: cockpit panels, flight control, radio systems, missile guidance systems...
- Space: military and commercial satellites, launcher...
- Medical: MRI, external defibrillators, implantable devices...
- Telecommunications: base stations...
- Oil and gas: drilling tools, MWD, LWD, wellheads...

ISO 9001 AND AS9100C

Quality is at the core of Exxelia's corporate culture. Each sites has its own certifications.

CERTIFICATIONS

Capacitors manufactured by EXXELIA comply with American and European standards and meet the requirements of many international standards.

For Space qualified parts (ESA QPL), please refer to our catalog «Ceramic capacitors for Space applications».

QUALITY & RELIABILITY

EXXELIA is committed to design and manufacture high quality and reliability products. The test cycles reproducing the most adverse operating conditions over extended periods (up to 10 000 hours) have logged to date well over 5.10⁹ hours/°C/component.

Failure rate data can be provided upon request.

CONFLICT MINERALS

EXXELIA is committed to an approach based on «Conflict Minerals Compliance». This US SEC rule demands complete traceability and a control mechanism for the mineral procurement chain, encouraging importers to buy only «certified» ore.

We have discontinued relations with suppliers that procure from the Democratic Republic of the Congo or an adjoining country.

ENVIRONMENT

EXXELIA is committed to applying a robust environmental policy, from product design through to shipment. To control its environmental footprint and reconcile this with the company's functional imperatives, our environmental policy provides for the reduction or elimination of hazardous substances. We also focus on compliance with European Union directives and regulations, notably REACH and RoHS.

RoHS COMPLIANCY

SMD CAPACITORS

The capacitor terminations are generally protected by a nickel barrier formed by electrolytic deposit. This barrier gives chip capacitors leaching performance far exceeding the requirements of all applicable standards. The nickel barrier guarantees a minimum resistance to soldering heat for a period of 1 minute at 260°C in a tin-lead (60/40) or tin-lead-silver (62/36/2) bath without noticeable alteration to the solderability. It also allows repeated soldering-unsoldering and the longer soldering times required by reflow techniques.

However nickel barrier amplifies thermal shock and is not recommended for chip sizes equal or greater than CNC Y (30 30) - (C 282 to C 288 - CNC 80 to CNC 94).

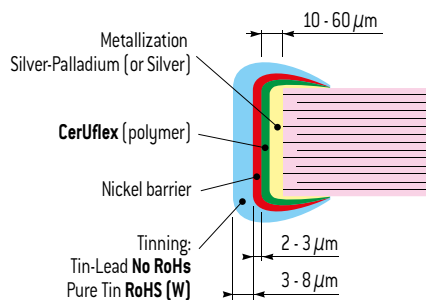















LEADED COMPONENTS

As well as for SMD products, leaded capacitors ranges can also be RoHS. These products, which are characterized by the suffix «W» added to the commercial type, are naturally compatible with the soldering alloys used in RoHS mounting technology. The connections coating is generally an alloy SnAg (with a maximum of 4% Ag). However, on a few products that EXXELIA will precise on request, the coating is pure silver.

Selection Guide

Main Characteristic	Model	Size	Dielectric	Voltage	Capacitance	Temperature	Coating					Leads				Mounting		Main Applications	Page
							Uncoated	Varnished	Conformal coated	Molded	Self-protected	DIL	Ribbon	Axial	Radial	SMD	Through hole		
STANDARD	CEC / CNC SERIES Low and Medium Voltage Chips Capacitors	0402 to 3040	NPO BX to 2C1 X7R	10V to 1,000V	1pF to 12μF	-55°C to +125°C	•											Precision, stability, decoupling	22
	NON MAGNETIC CHIPS SERIES Low and Medium Voltage Chips Capacitors	0603 to 2220	NPO X7R	63V to 500V	10pF to 1μF	-55°C to +125°C	•											Precision, stability, decoupling	26
	OP SERIES Open Mode Chips Capacitors	0805 to 2220	NPO X7R	10V to 100V	1pF to 4.7μF	-55°C to +125°C	•											Precision, stability, decoupling, Significantly reduce risk of short circuit	28
	CER / CNR SERIES Low Inductance Chips Capacitors	0306 to 0612	NPO X7R	16V to 100V	1pF to 270nF	-55°C to +125°C	•											Decoupling, low ESL, medical embedded	30
	C3N / C4N / C3E / C4E SERIES Capacitors Arrays	-	NPO X7R	25V to 200V	4.7pF to 33nF	-55°C to +125°C	•											Medical embedded, miniaturisation	32
	30 S4 SERIES Safety Capacitors	-	NPO X7R	40V to 100V	470pF to 820nF	-55°C to +125°C	•				•							Railway	33
	TCE / TCX / TCN / TXR MOLDED SERIES Radial Molded Capacitors	-	NPO BX to 2C1 X7R	25V to 500V	1pF to 4.7μF	-55°C to +125°C			•									Precision, stability, decoupling	34
	LA SERIES Radial Molded Capacitors	-	NPO Temp. coeff.	25V to 63V	1pF to 680nF	-55°C to +125°C			•									Decoupling	36
	TCE / TCX / TCN / TXR AXIAL SERIES Axial Molded Capacitors	-	NPO BX - 2C1 X7R	25V to 500V	1pF to 3.9μF	-55°C to +125°C			•									Precision, stability, decoupling	38
	TCE / TCX / TCN / TXR CONFORMAL COATED SERIES Radial Dipped Capacitors	-	NPO BX - 2C1 X7R	25V to 500V	1pF to 6.8μF	-55°C to +125°C			•									Precision, stability, decoupling	40
	NON MAGNETIC CONFORMAL COATED SERIES Radial Dipped Capacitors	-	NPO X7R	63V to 500V	180pF to 1μF	-55°C to +125°C			•									Precision, stability, decoupling	42
	CK SERIES Radial Molded Capacitors	-	BX	25V to 250V	10pF to 1μF	-55°C to +125°C			•									Decoupling	44
HIGH VOLTAGE	C Series High voltage chips Capacitors	1812 to 16080	NPO C4xx X7R	200V to 10kV	10pF to 39μF	-55°C to +125°C	•												51
	TCL / TCK Series High voltage Molded & Varnished leaded Capacitors	-	NPO C4xx X7R	200V to 10kV	10pF to 39μF	-55°C to +125°C			•		•								54
	TCF Series High voltage Conformal coated leaded Capacitors	-	NPO C4xx X7R	200V to 10kV	10pF to 39μF	-55°C to +125°C			•									Power supply, voltage multiplier, radars. • aerospace • space • defence • railways	57
	TKD Series High voltage Conformal coated leaded Capacitors	-	NPO C4xx X7R	200V to 10kV	10pF to 39μF	-55°C to +125°C			•										60
	CS Series High voltage Stacked Capacitors	2220 to 16080	NPO C4xx X7R	1kV to 10kV	220pF to 15μF	-55°C to +125°C	•	•			•	•							62
	VM Series Voltage Multipliers	-	-	-	-	-	-55°C to +125°C												65

Selection Guide

Main Characteristic	Model	Size range	Dielectric	Voltage range	Capacitance range	Temperature range	Coating					Leads				Mounting		Main Applications	Page
							Uncoated	Varnished	Conformal coated	Molded	Self protected	DIL	Ribbon	Axial	Radial	SMD	Through hole		
HIGH CAPACITANCE	R SERIES (CHIPS) High Capacitance Chips Capacitors 	2225 to 45107	X7R	50V to 500V	47nF to 27µF	-55°C to +125°C	•									•		Switch Mode Power Supply, filtering, smoothing, decoupling.	73
	R SERIES (LEADED) Radial Leaded Conformal Coated Capacitors 	-	X7R	50V to 500V	47nF to 27µF	-55°C to +125°C			•							•			77
	TEF SERIES Radial Leaded Conformal Coated Capacitors 	-	NPO	63V to 500V	10nF to 680nF	-55°C to +125°C			•							•			80
	SV / SC SERIES High Capacitance Stacked Capacitors 	2225 to 125205	X7R	50V to 500V	47nF to 390µF	-55°C to +125°C	•	•			•	•				•	•		81
	CNC3X SERIES High Capacitance Stacked Capacitors 	2220 to 4040	X7R	16V to 25V	1.2µF to 68µF	-55°C to +125°C	•	•			•					•	•		88
	CEC5X SERIES High Capacitance Stacked Capacitors 	3033 to 80150	NPO	63V to 500V	10nF to 6.8µF	-55°C to +125°C	•	•			•					•	•		90
	TEP / TEV SERIES High Capacitance Stacked Capacitors 	-	NPO	63V to 500V	10nF to 6.8µF	-55°C to +125°C		•								•	•		93
TCN8X SERIES High Capacitance Molded Stacked Capacitors 	-	X7R	63V to 500V	0.47µF to 120µF	-55°C to +125°C				•						•	•		95	
HIGH TEMPERATURE	CE / CN SERIES High Temperature Chips Capacitors 	0402 to 3040	NPO to X7R	16V to 100V	1pF to 8.2µF	-55°C to +250°C	•									•			100
	SCT SERIES High Temperature Stacked Capacitors 	2225 to 125205	X7R	50V to 500V	47nF to 390µF	-55°C to +215°C	•	•			•					•	•		102
	TCE / TCN MOLDED SERIES HT High Temperature Molded Capacitors 	-	NPO to X7R	16V to 100V	1pF to 10µF	-55°C to +220°C				•						•	•		107
	TCE / TCN SELF-PROTECTED SERIES High Temperature Self-Protected Capacitors 	-	NPO to X7R	25V to 500V	10pF to 3.9µF	-55°C to +250°C					•					•	•		109
	TCH SERIES High Temperature High Voltage Capacitors 	-	NPO to X7R	200V to 10kV	10pF to 15µF	-55°C to +250°C		•								•	•		111
FEED-THRU	TBC SERIES Discoidal Capacitors 	-	NPO to X7R	25V to 1kV	10pF to 12µF	-55°C to +125°C	•									•		Very low ESL	115
	BPM SERIES Planar Array 	-	X7R	25V to 200V	330pF to 68nF	-55°C to +125°C	•									•		Very low ESL, miniaturisation	117

Selection Guide

Main Characteristic	Model	Size range	Dielectric	Voltage range	Capacitance range	Temperature range	Coating					Leads				Mounting		Main Applications	Page	
							Uncoated	Varnished	Conformal coated	Molded	Self protected	DIL	Ribbon	Axial	Radial	SMD	Through hole			
HIGH Q	XBL SERIES Broadband	0402	X7R	16V	100nF	-55°C to +125°C	•											DC Blocking, Coupling, Bypassing	138	
	UBL SERIES Broadband	0402	X7R	16V	100nF	-55°C to +125°C	•										Cellular base station amplifier, MRI.			140
	UBZ SERIES Broadband	0201	X5R X6T	10V	100nF	-55°C to +105°C	•													
	CH SERIES Classic HiQ	0505 1111	P100	50V to 1.5kV	0.1pF to 1nF	-55°C to +175°C	•				•	•	•				Cellular base station equipment Broadband Point to point/ multi-point radios RF generators	144		
	SH SERIES Super HiQ	0402 to 1210	NPO	25V to 1.5kV	0.2pF to 1nF	-55°C to +150°C	•				•	•	•							
	SHD / SHR SERIES Reverse Geometry	0709 0711	NPO	500V	0.5pF to 100pF	-55°C to +175°C	•								•		RF power amplifier Plasma chamber MRI coils	147		
	NHB SERIES High Self Resonant Frequency	1111	NPO	500V	0.3pF to 100pF	-55°C to +175°C	•								•					
	CP SERIES High Power	2225 4040	P100	200V to 7kV	1pF to 10nF	-55°C to +125°C	•	•			•	•	•	•	•	•	RF power amplifier Plasma chamber MRI coils	150		
	CL SERIES High Power	2225 to 7065	NPO	200V to 7kV	1pF to 10nF	-55°C to +125°C	•	•			•	•	•	•	•	•				

ADDITIONAL AVAILABLE RANGES (consult our website)

STANDARD	TCE1X Series	-	NPO	63V to 100V	0.5pF to 10nF	-55°C to +125°C				•								Precision, stability, decoupling	-
	TCN19 Series	-	2C1	63V to 250V	10pF to 1µF	-55°C to +125°C					•							Decoupling	-
	TCN3X Series	-	2C1	50V to 100V	100pF to 1,8µF	-55°C to +125°C					•								
	LA6 Series	-	2C1	25V to 63V	100pF to 1µF	-55°C to +125°C					•								
HIGH VOLT.	H Series	0805 to 6560	NPO X7R	1kV to 10kV	2pF to 390nF	-55°C to +125°C	•	•										Power supply, voltage multiplier, radars.	-
HIGH CAPACITANCE	CNC5X Series	3033 to 80150	X7R	63V to 500V	0.1µF to 180µF	-55°C to +125°C	•	•			•							Switch Mode Power Supply, filtering, smoothing, decoupling. • aerospace • space • defence	-
	CNC8X Series (chips)	3033 to 33110	X7R	63V to 400V	47nF to 27µF	-55°C to +125°C	•												
	CNC8X Series (DIL)	3333 to 80150	X7R	63V to 400V	47nF to 180µF	-55°C to +125°C	•	•			•								
	TCP / TCV8X Series	3333 to 80150	X7R	63V to 400V	47nF to 180µF	-55°C to +125°C		•											
	TCP / TCV5X Series	3033 to 80150	X7R	63V to 500V	0.1µF to 180µF	-55°C to +125°C		•											
	TCF Series	-	X7R	63V to 500V	0.1µF to 18µF	-55°C to +125°C			•										
HIGH TEMP.	CNC25X Series	3033 to 5550	X7R	50V	1µF to 33µF	-55°C to +200°C	•	•			•						Oil drilling, motor control, braking systems.	-	
HIGH Q	CNW Series	-	X7R	100V to 300V	10nF to 1µF	-55°C to +125°C	•					•	•				Power amplifier	-	
	SPT519 / CAW CEW Series	-	NPO	100V to 300V	10nF to 1µF	-55°C to +125°C	•	•											

Ceramic Capacitors Technology

MLCC STRUCTURE

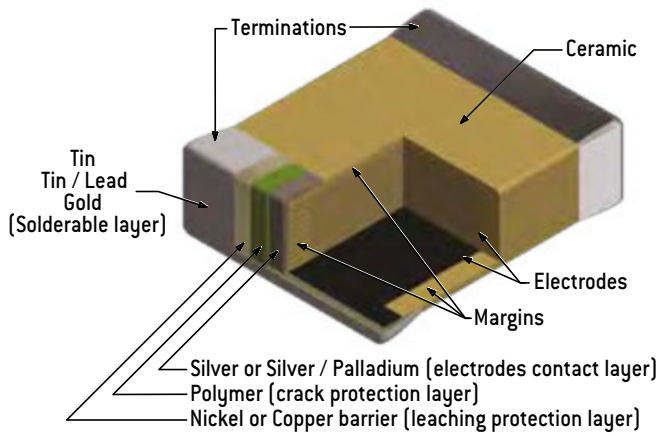

EQUIVALENT CIRCUIT

Capacitor is a complex component combining resistive, inductive and capacitive phenomena. A simplified schematic for the equivalent circuit is:

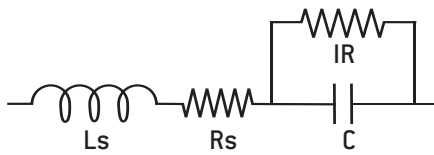

DIELECTRIC CHARACTERISTICS

Insulation Resistance (IR) is the resistance measured under DC voltage across the terminals of the capacitor and consists principally of the parallel resistance shown in the equivalent circuit. As capacitance values and hence the area of dielectric increases, the IR decreases and hence the product (C x IR) is often specified in $\Omega \cdot F$ or $M\Omega \cdot \mu F$.

The Equivalent Series Resistance (ESR) is the sum of the resistive terms which generate heating when capacitor is used under AC voltage at a given frequency (f).

Dissipation factor (DF) is the ration of the apparent power input will turn to heat in the capacitor:

$$DF = 2\pi f C ESR$$

When a capacitor works under AC voltage, **heat power loss (P)**, expressed in Watt, is equal to:

$$P = 2\pi f C V_{rms}^2 DF$$

The series inductance (Ls) is due to the currents running through the electrodes. It can distort the operation of the capacitor at high frequency where the **impedance (Z)** is given as:

$$Z = R_s + j (L_s \cdot \omega - 1 / (C \cdot \omega)) \text{ with } \omega = 2\pi f$$

When frequency rises, the capacitive component of capacitors is gradually canceled up to the resonance frequency, where :

$$Z = R_s \text{ and } L_s C \cdot \omega^2 = 1$$

Above this frequency the capacitor behaves like an inductor.

	P100	NPO	N2200 (C4xx)	BX	2C1	X7R
Dielectric material	Porcelain	Magnesium titanate or Neodymium baryum titanate	Barium zirconate titanate	Baryum titanate (BaTiO ₃)		
Dielectric constant	15 – 18	20 – 85	450	2,000 – 5,000		
Electrode technology	PME (Precious Metal Electrodes): Ag/Pd					
Capacitance variation between –55°C and +125°C without DC voltage	(100 ± 30)ppm/°C	(0 ± 30)ppm/°C	(–2,200 ± 500) ppm/°C	± 15%	± 20%	± 15%
Capacitance variation between –55°C and +125°C with DC rated voltage			0 -15%	15% –25%	20% –30%	Not applicable
Piezo-electric effect	None		None	Yes		
Dielectric absorption	None		Few %	Few %		
Thermal shock sensitive	+		+	++		

Ceramic Capacitors Technology

MANUFACTURING STEPS

SLIP CASTING



A slurry, a mix of ceramic powder, binder and solvents, is poured onto conveyor belt inside a drying oven, resulting in a dry ceramic sheet.

ELECTRODE SCREEN PRINTING

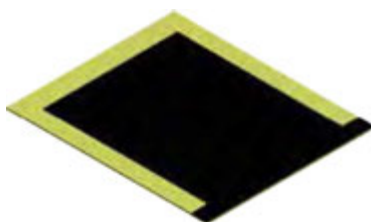

The electrode ink, made from a metal powder mixed with solvents, is printed onto the ceramic sheets using a screen printing process.

STACKING

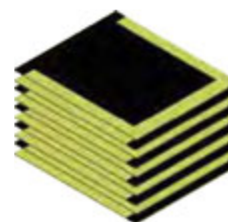

The sheets with electrode printed are stacked to create a multilayer structure.

TERMINATIONS

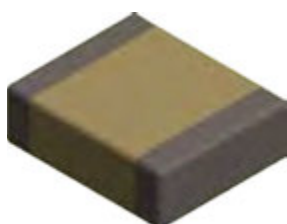

Each terminal of the capacitor is dipped in the termination ink, mix of metal powder, solvents and glass frit and the parts are fired in an oven.

SINTERING

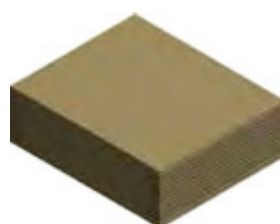

The parts are sintered in an oven with a precise temperature profile which is very important to the characteristics of the capacitors.

PRESSING

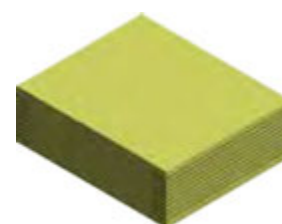

Pressure is applied to the stack to fuse all the separate layers, this created a monolithic structure.

TERMINATIONS PLATING

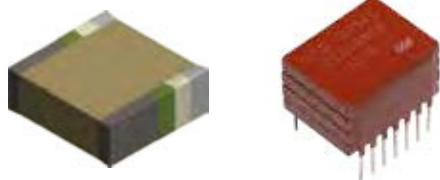

Stacking + leads soldering + encapsulation
[see pages 10-11]

FINAL TESTING

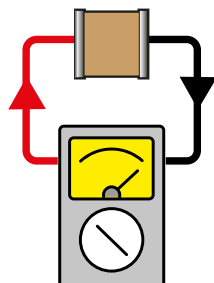

PACKAGING



User Guide

SMD TERMINATIONS

NON RoHS COMPLIANT	Code	RoHS COMPLIANT	Code	Recommended mounting process							Storage [months]*
				Magnetic	Epoxy bonding	Iron soldering	Wave soldering	Vapor phase soldering	Infrared soldering	Wire bonding	
Ag	Q	Ag	QW / P	No	•	•	•	•			18
Ag/Pd/Pt	-	Ag/Pd/Pt	W / A	No	•	•	•				24
Ag + Ni + dipped Sn/Pb 60/40	T**	-	-	No		•	•	•	•		24
Ag/Pd/Pt + dipped Sn/Pb 60/40	H	Ag/Pd/Pt + dipped Sn	HW	No		•					24
Ag + Ni + electrolytic Sn/Pb 95/5	C	Ag + Ni + electrolytic Sn	CW / S	Yes		•	•	•	•		18
Ag + Ni + electrolytic Sn/Pb 60/40	D	-	-	Yes		•	•	•	•		18
-	-	Ag + Cu + electrolytic Sn	C***	No		•	•	•	•		18
Ag + Ni + dipped Sn/Pb 60/40	E	Ag + Ni + electrolytic Sn	EW	Yes		•	•				24
Ag + Ni + Au	G	Ag + Ni + Au	GW	Yes	•	•	•	•	•	•	36
Ag + Polymer + Ni + Sn/Pb 95/5	YC	Ag + Polymer + Ni + Sn	YCW	Yes		•	•	•	•		18
Ag + Polymer + Ni + Sn/Pb 60/40	YD	-	-	Yes		•	•	•	•		18
Ag + Polymer + Ni + Au	YG	Ag + Polymer + Ni + Au	YGW	Yes	•	•	•	•	•	•	36

Nickel (Ni) or Copper (Cu) barriers amplify thermal shock and are not recommended for chip sizes larger than 3030.

* Storage must be in a dry environment at a temperature of 20°C with a relative humidity below 50%, or preferably in a package enclosing a desiccant.

** Maintenance only.

*** Non magnetic chips series only.

SMD ENVIRONMENTAL TESTS

Ceramic chip capacitors for SMD are designed to meet test requirements of **CECC 32100** and **NF C 93133** standards as specified below in compliance with **NF C 20700** and **IEC 68** standards:

- Solderability: **NF C 20758**, 260°C, bath 62/36/2.
- Adherence: 5N force.
- Vibration fatigue test: **NF C 20706**, 20 g, 10 Hz to 2,000 Hz, 12 cycles of 20 minutes each.
- Rapid temperature change: **NF C 20714**, -55°C to + 125°C, 5 cycles.
- Combined climatic test: **IEC 68-2-38**.
- Damp heat: **NF C 20703**, 93 %, H.R., 40°C.
- Endurance test: 1,000 hours, 1.5 U_{RC}, 125°C.

STORAGE OF CHIP CAPACITORS

TINNED OR NON TINNED CHIP CAPACITORS

Storage must be in a dry environment at a temperature of 20°C with a relative humidity below 50 %, or preferably in a packaging enclosing a desiccant.

STORAGE IN INDUSTRIAL ENVIRONMENT:

- 2 years for tin dipped chip capacitors,
- 18 months for tin electroplated chip capacitors,
- 2 years for non tinned chip capacitors,
- 3 years for gold plated chip capacitors.

STORAGE IN CONTROLLED NEUTRAL NITROGEN ENVIRONMENT:

- 4 years for tin dipped or electroplated chip capacitors,
- 4 years for non tinned chip capacitors,
- 5 years for gold plated chip capacitors.

Storage duration should be considered from delivery date and not from batch manufacture date. The tests carried out at final acceptance stage [solderability, susceptibility to solder heat] enable to assess the compatibility to surface mounting of the chips.

User Guide

LEAD STYLES

SURFACE MOUNTING

DIL LEADS

P style



PL style



L style



J style

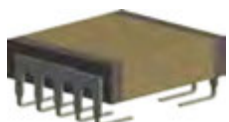

RIBBON LEADS

Micro-strip (type 1)
Short Micro-strip (type 1S)

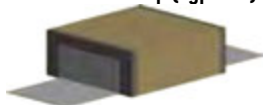

Axial (Type 2)



Radial (Type 3)



R style

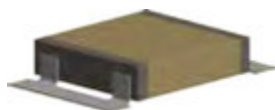

RX style

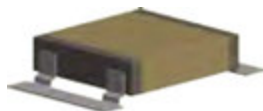

RJ style

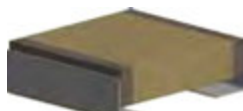

Please contact Exxelia sales for any lead configuration not shown.

TROUGH-HOLE MOUNTING

AXIAL AND RADIAL

Radial leads (Type 6)



Radial leads (4 leads)



Axial leads (Type 7)



DIL leads: N style

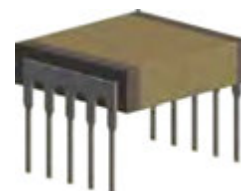

ENCAPSULATION STYLES

Ceramic encapsulation
(selfprotected)



Varnish



Conformal coating



Molding



User Guide

SOLDERING ADVICES FOR REFLOW SOLDERING

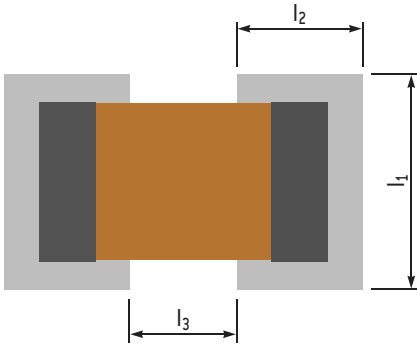

Large chips above size 2225 are not recommended to be mounted on epoxy board due to thermal expansion coefficient mismatch between ceramic capacitor and epoxy. Where larger sizes are required, it is recommended to use components with ribbon or other adapted leads so as to absorb thermo-mechanical strains.

Dimensions in inches (in mm)	Reflow soldering						Wave soldering					
	l ₁		l ₂		l ₃		l ₁		l ₂		l ₃	
0402	0.043	(1.1)	0.035	(0.9)	0.012	(0.3)	0.043	(1.1)	0.047	(1.2)	0.012	(0.3)
0403	0.055	(1.4)	0.035	(0.9)	0.012	(0.3)	0.055	(1.4)	0.047	(1.2)	0.012	(0.3)
0504	0.063	(1.6)	0.051	(1.3)	0.016	(0.4)	0.063	(1.6)	0.063	(1.6)	0.016	(0.4)
0603	0.055	(1.4)	0.059	(1.5)	0.02	(0.5)	0.055	(1.4)	0.071	(1.8)	0.02	(0.5)
0805	0.073	(1.85)	0.065	(1.65)	0.024	(0.6)	0.073	(1.85)	0.077	(1.95)	0.024	(0.6)
0907	0.094	(2.4)	0.065	(1.65)	0.035	(0.9)	0.094	(2.4)	0.077	(1.95)	0.035	(0.9)
1005	0.073	(1.85)	0.067	(1.7)	0.039	(1)	0.073	(1.85)	0.079	(2)	0.039	(1)
1206	0.083	(2.1)	0.067	(1.7)	0.059	(1.5)	0.083	(2.1)	0.079	(2)	0.059	(1.5)
1210	0.118	(3)	0.069	(1.75)	0.059	(1.5)	0.118	(3)	0.081	(2.05)	0.059	(1.5)
1605	0.073	(1.85)	0.071	(1.8)	0.087	(2.2)	0.073	(1.85)	0.083	(2.1)	0.087	(2.2)
1806	0.087	(2.2)	0.073	(1.85)	0.102	(2.6)	0.087	(2.2)	0.085	(2.15)	0.102	(2.6)
1812	0.152	(3.85)	0.073	(1.85)	0.102	(2.6)	0.152	(3.85)	0.085	(2.15)	0.102	(2.6)
1825	0.281	(7.15)	0.073	(1.85)	0.102	(2.6)	0.281	(7.15)	0.085	(2.15)	0.102	(2.6)
2210	0.13	(3.3)	0.079	(2)	0.146	(3.7)	0.13	(3.3)	0.091	(2.3)	0.146	(3.7)
2220	0.228	(5.8)	0.079	(2)	0.146	(3.7)	0.228	(5.8)	0.091	(2.3)	0.146	(3.7)
2225	0.281	(7.15)	0.079	(2)	0.146	(3.7)	0.281	(7.15)	0.091	(2.3)	0.146	(3.7)

RECOMMENDED FOOTPRINT FOR SMD CAPACITORS

Ceramic is by nature a material which is sensitive both thermally and mechanically. Stresses caused by the physical and thermal properties of the capacitors, substrates and solders are attenuated by the leads.

Wave soldering is unsuitable for sizes larger than 2220 and for the higher ends of capacitance ranges due to possible thermal shock (capacitance values given upon request).

Infrared and vapor phase reflow, are preferred for high reliability applications as inherent thermo-mechanical strains are lower than those inherent to wave soldering.

Whatever the soldering process is, it is highly recommended to apply a thermal cycle, see hereafter our recommended soldering profile:

RECOMMENDED VAPOR PHASE REFLOW PROFILE

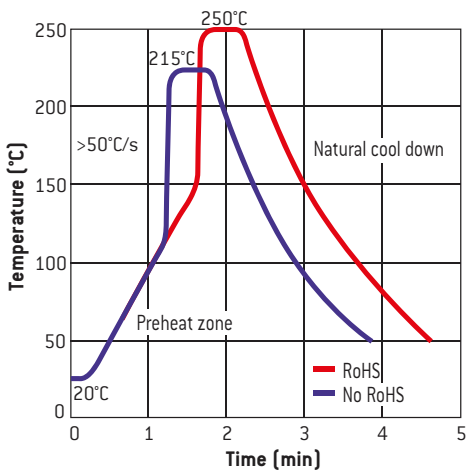

RECOMMENDED IR REFLOW PROFIL

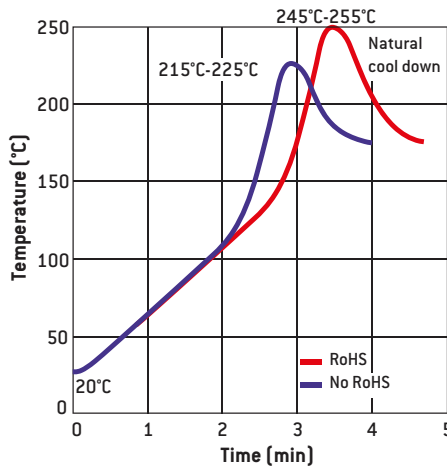

RECOMMENDED WAVE SOLDERING PROFILE

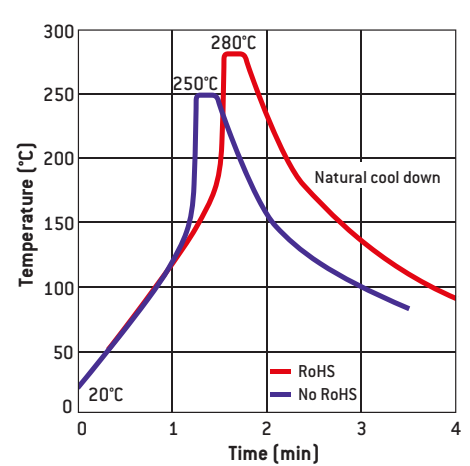

SOLDERING ADVICES FOR IRON SOLDERING

Attachment with a soldering iron is discouraged due to ceramic brittleness and the process control limitations. In the event that a soldering iron must be used, the following precautions should be observed:

- Use a substrate with chip footprints big enough to allow putting side by side one end of the capacitor and the iron tip without any contact between this tip and the component,
- place the capacitor on this footprint,

- heat the substrate until the capacitor's temperature reaches 150°C minimum (preheating step, maximum 1°C per second),
- place the hot iron tip (a flat tip is preferred) on the footprint **without touching the capacitor**. Use a regulated iron with a 30 watts maximum power. The recommended temperature of the iron is 270 ± 10°C. The temperature gap between the capacitor and the iron tip must not exceed 120°C,

User Guide

- leave the tip on the footprint for a few seconds in order to increase locally the footprint's temperature,
- use a cored wire solder and put it down on the iron tip. In a preferred way use Sn/Pb/Ag 62/36/2 alloy,
- wait until the solder fillet is formed on the capacitor's termination,
- take away iron and wire solder,

- wait a few minutes so that the substrate and capacitor come back down to the preheating temperature,
- solder the second termination using the same procedure as the first,
- let the soldered component cool down slowly to avoid any thermal shock.

PACKAGING

TAPE AND REEL

The films used on the reels correspond to standard IEC 60286-3. Films are delivered on reels in compliance with document IEC 286-3 dated 1991.

Minimum quantity is 250 chips.

Maximum quantities per reel are as follows:

- Super 8 reel - Ø 180: 2,500 chips.
- Super 8 reel - Ø 330: 10,000 chips.
- Super 12 reel - Ø 180: 1,000 chips.

Reel marking complies with CECC 32100 standard:

- Model.
- Rated capacitance.
- Capacitance tolerance.
- Rated voltage.
- Batch number.

TRAY PACKAGES

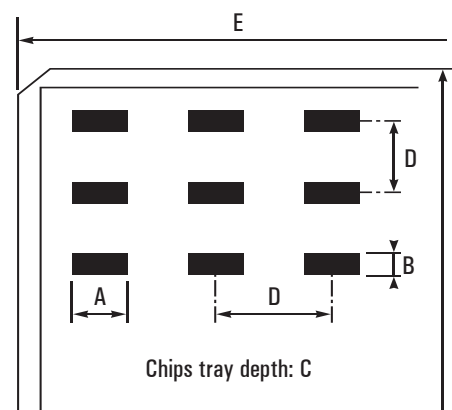

DIMENSIONAL CHARACTERISTICS OF CHIPS TRAY PACKAGES

Sizes	Nr. of chips/ package	Oriented chips	Dimensions in inches (in mm)				
			A	B	C	D	E
0402	100	No	0 0.112 [0 3.02]		0.065 [1.65]	0.167 [4.24]	2 [50.8]
0403	100	No	0 0.112 [0 3.02]		0.065 [1.65]	0.167 [4.24]	2 [50.8]
0504	100	Yes	0.059 [1.5]	0.045 [1.14]	0.035 [0.89]	0.167 [4.24]	2 [50.8]
0603	340	Yes	0.1 [2.54]	0.06 [1.52]	0.045 [1.14]	0.167 [4.24]	2 [50.8]
0805	100	Yes	0.1 [2.54]	0.06 [1.52]	0.045 [1.14]	0.167 [4.24]	2 [50.8]
1206	100	No	0.14 [3.56]	0.14 [3.56]	0.06 [1.52]	0.167 [4.24]	2 [50.8]
1210	100	Yes	0.14 [3.56]	0.14 [3.56]	0.06 [1.52]	0.167 [4.24]	2 [50.8]
1812	100	No	0.25 [6.35]	0.25 [6.35]	0.13 [3.3]	0.345 [8.76]	4 [101.6]
	25	Yes	0.24 [6.1]	0.265 [6.73]	0.07 [1.78]	0.345 [8.76]	2 [50.8]
2220	100	Yes	0.25 [6.35]	0.25 [6.35]	0.13 [3.3]	0.345 [8.76]	4 [101.6]
	25	Yes	0.24 [6.1]	0.265 [6.73]	0.07 [1.78]	0.345 [8.76]	2 [50.8]

HIGH Q CAPACITORS TAPE AND REEL PACKAGING SPECIFICATIONS

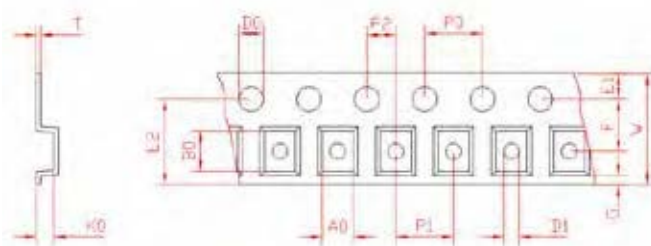

Sizes	Type [1]	W±0.3 inches (mm)	F ±0.05 inches (mm)	P1 ±0.1 inches (mm)	T max. inches (mm)	Reel Size inches (mm)	Quantity per Reel
A [0505]	H	0,315 [8]	0,138 [3.5]	0,157 [4]	0,010 [0,25]	7,087 [180]	3'000
A [0505]	V	0,315 [8]	0,138 [3.5]	0,157 [4]	0,010 [0,25]	7,087 [180]	3'000
S [0603]	H	0,315 [8]	0,138 [3.5]	0,157 [4]	0,016 [0,4]	7,087 [180]	4'000
F [0805]	H	0,315 [8]	0,138 [3.5]	0,157 [4]	0,016 [0,4]	7,087 [180]	4'000
B [1111]	H	0,315 [8]	0,138 [3.5]	0,157 [4]	0,012 [0,3]	7,087 [180]	1'000
B [1111]	V	0,315 [8]	0,138 [3.5]	0,157 [4]	0,010 [0,25]	7,087 [180]	1'000
X [2225]	H	0,472 [12]	0,138 [5.5]	0,472 [12]	0,018 [0,45]	12,992 [330]	500
E [4040]	H	0,945 [24]	0,453±0,004 [11.5±0.1]	0,630 [16]	0,018 [0,45]	12,992 [330]	700
E [4040]	V	1,260 [32]	0,559±0,004 [14.2±0.1]	0,945 [24]	0,022 [0,55]	15 [381]	350

[1]: Horizontal (H) or Vertical (V) orientation in cavities.

User Guide

EIA STANDARD CAPACITANCE VALUES

Following EIA standard, the values and multiples that are indicated in the chart below can be ordered. E48, E96 series and intermediary values are available upon request.

E6 (± 20%)	E12 (± 10%)	E24 (± 5%)
10	10	10
		11
		12
15	12	13
		15
		16
22	15	18
		20
		22
33	18	24
		27
		30
47	22	33
		36
		39
68	33	43
		47
		51
100	39	56
		62
		68
150	47	75
		82
		91

EIA CAPACITANCE CODE

The capacitance is expressed in three digit codes and in units of pico Farads (pF). The first and second digits are significant figures of the capacitance value and the third digit identifies the multiplier.

For capacitance value < 10pF, R designates a decimal point.
See examples below:

EIA code	Capacitance value		
	in pF	in nF	in μ F
2R2	2.2	0.0022	0.0000022
6R8	6.8	0.0068	0.0000068
220	22	0.022	0.000022
470	47	0.047	0.000047
181	180	0.18	0.00018
221	220	0.22	0.00022
102	1,000	1	0.001
272	2,700	2.7	0.0027
123	12,000	12	0.012
683	68,000	68	0.068
124	120,000	120	0.12
564	560,000	560	0.56
335	3,300,000	3,300	3.3
825	8,200,000	8,200	8.2
156	15,000,000	15,000	15
686	68,000,000	68,000	68
107	100,000,000	100,000	100
227	220,000,000	220,000	220

PART MARKING VOLTAGE CODES

Use the following voltage code chart for part markings:

Voltage (V)	Code	Letter code
25	250	A
40	400	B
50	500	C
63	630	D
100	101	E
200	201	G
250	251	H
400	401	K
500	501	L
1,000	102	M
2,000	202	P
3,000	302	R
4,000	402	S
5,000	502	T
7,500	752	U
10,000	103	W

PART MARKING TOLERANCE CODES

Use the following tolerance code chart for part markings:

Tolerance	Letter code
± 0.25pF	CU
± 0.5pF	DU
± 1pF	FU
± 1%	F
± 2%	G
± 5%	J
± 10%	K
± 20%	M

User Guide

RELIABILITY LEVELS

Exxelia proposes different reliability levels for the ceramic capacitors for both NPO and X7R ceramics.

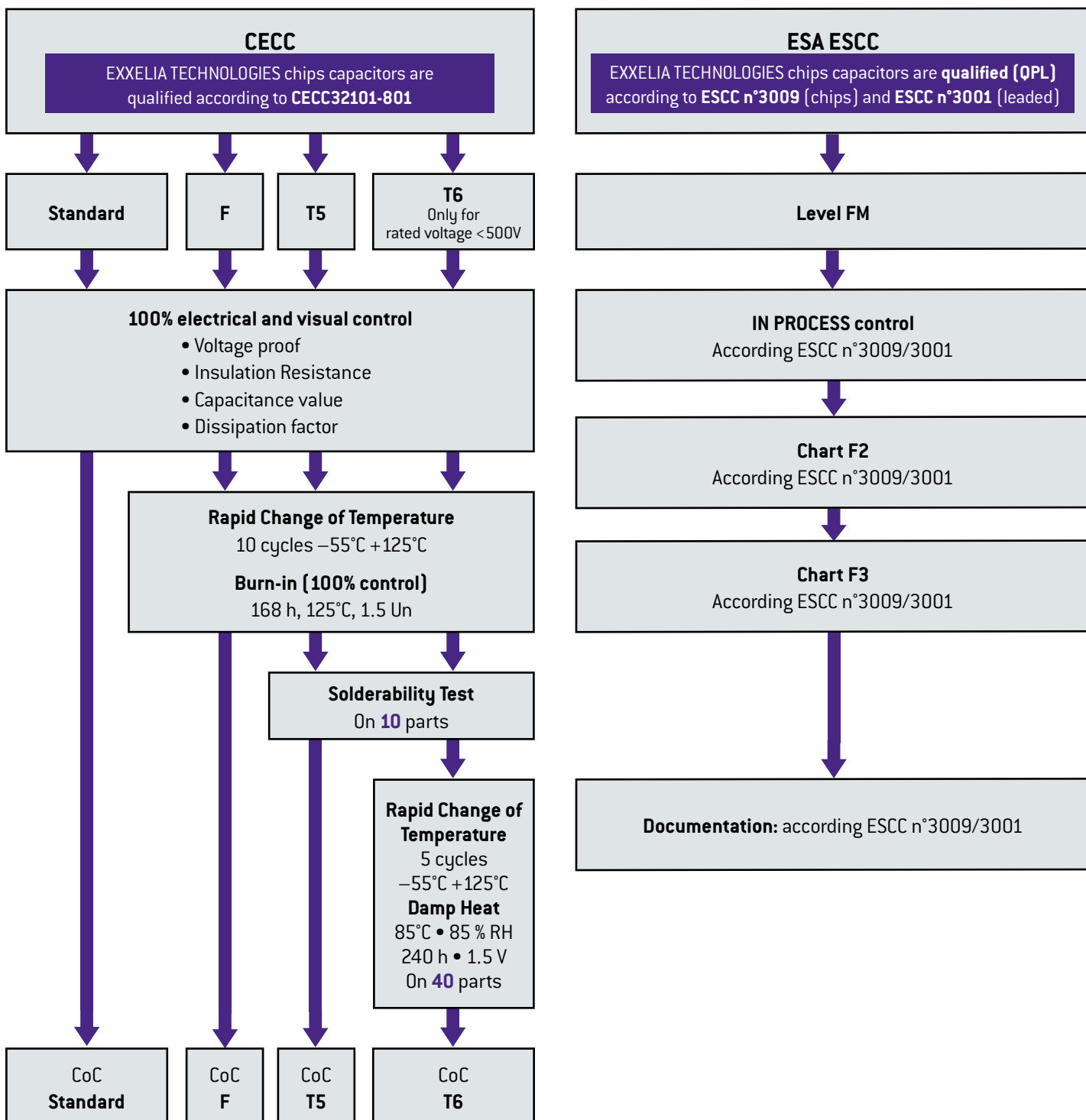

As the world's leading manufacturer of specific passive components, we stand apart through our ability to quickly evaluate the application specific engineering challenges and provide a cost-effective and efficient solutions.

For requirements that cannot be met by catalog products, we offer leading edge solutions in custom configuration: custom geometries, packaging, characteristics, all is possible thanks to our extensive experience and robust development process, while maintaining the highest level of reliability.

Where necessary, special testing is done to verify requirements, such as low dielectric absorption, ultra-high insulation resistance, low dissipation factor, stability under temperature cycling or under specified environmental conditions, etc.

HIGH CAPACITANCE

- High energy density
- Specific case sizes
- Specific shape of connections (high resistance to vibrations)



HIGH VOLTAGE

- Up to 50 kV
- Specific circular shape

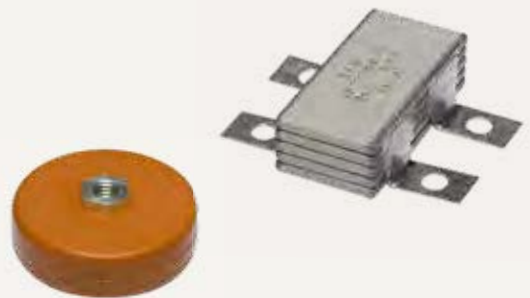

HIGH TEMPERATURE

- Up to 250°C
- Specific shape of connections
- 2,000 hours life time
- HMP soldering

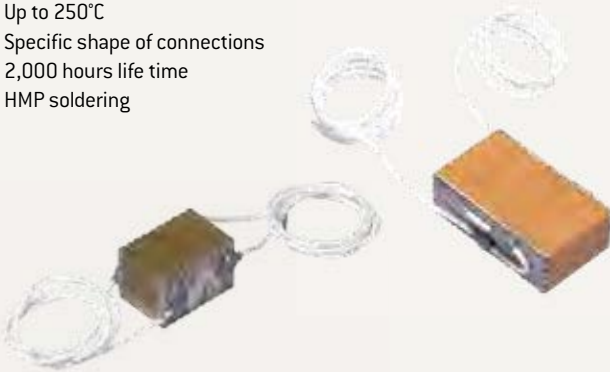

OTHERS

- Screen printed resistors
- Complex components
- Full functions available

