

SCT Series

High Temperature Stacked Capacitors



FEATURES

- Multilayer stacked ceramic capacitors
- Dielectric type II
- Capacitance range: 47nf to 390 μF
- Voltage range: 50 V_{DC} to 500 V_{DC}

TERMINATIONS

- Ag 100% termination developed for high temperature up to 215°C. Less sensitive to thermal shocks and compatible with high melting point solder containing lead.
- DIL type J, L or N are available.

MARKING

Size	Marking codes	Example
	«TA» logo	TA
All sizes	Cap code + Tolerance code	105M
	Rated voltage value	100 V

ELECTRICAL SPECIFICATIONS

Description	«X» Series (type II)
CECC	2R1
EIA	X7R
Exxelia Temex Code	X
Operating temperature range	-55°C to +215°C
Maximun ΔC/°C over Temperature range without voltage applied	± 15%
Ageing	≤ 2.5% per decade hour
Dissipation Factor (DF)	≤ 2.5%
Voltage proof	U _R ≤ 200 V: 2.5 x U _R U _R > 200 V: 2.0 x U _R
Insulation Resistance (IR) at 25°C under U _R	100GΩ or 1000Ω.F whichever is the less
Insulation Resistance (IR) at 125°C under U _R	10GΩ or 100Ω.F whichever is the less
Measurement Conditions for C and DF at 20°C	≤ 100pF: 1MHz / 1Vrms (no bias) > 100pF: 1KHz / 1Vrms (no bias)
Capacitance versus applied Voltage and Temperature	See page 99

PACKAGING

«Blister» boxes:

For all products, special «blister» boxes are used to optimize the protection of the parts during the carriage and the storage. Depending upon the termination (with or without connection) and the size, the number of the parts in each box is defined. Please, consult us for more details.

HOW TO ORDER

201	SCT	01	X	105	K	R	-	-RoHS
Rated voltage	Series	Exxelia size code	Dielectric code	Capacitance	Tolerance	Termination	Coating	RoHS Compliant
500: 50 V 101: 100 V 201: 200 V 501: 500 V	SCT	00 01 02 04 05 06 07 10 12	X = X7R	1 st two digits represent significant figures; last digit specifies the number of zeros to follow. Examples: 104: 0.1μF 335: 3.3μF 156: 15μF 107: 10μF	K = ± 10% M = ± 20%	DN DIL N type DJ DIL J type DL DIL L type	RoHS = HMP tinned phosphor bronze, non magnetic. - = uncoated and no marking U = uncoated and marked	Non-RoHS not available

DIMENSIONS in inches (mm)

SC SERIES

Dual In Line DIL termination

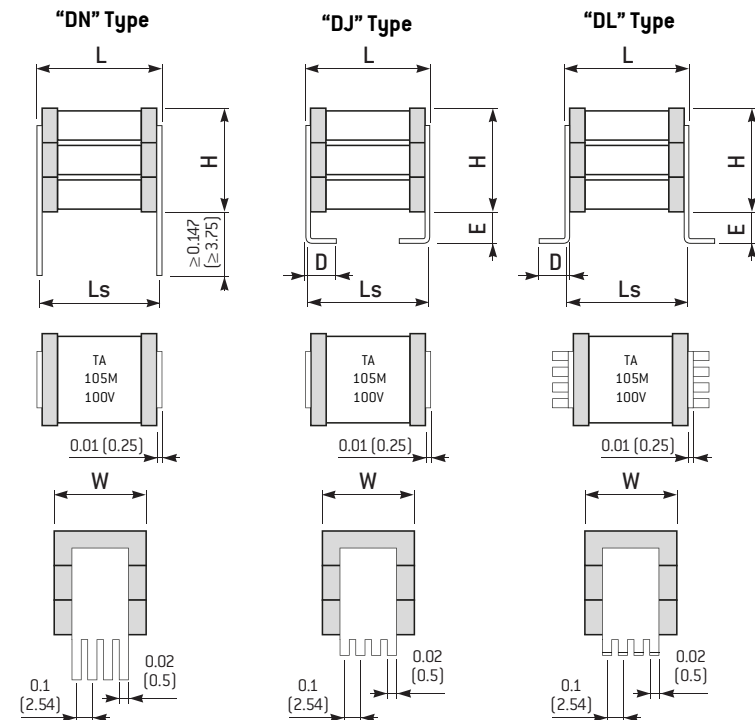

Note: the marking shown here is just given as an example

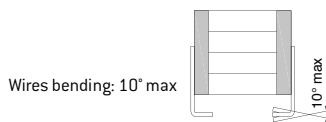

Size	L max.	W max.	LS $\pm 0.02^*$ (± 0.5) [*]	E ± 0.012 (± 0.5) ^{**}	D ± 0.02 (± 0.5)	Number of leads per side	H max.
SCT00	0.300 (7.62)	0.276 (?)	0.250 (6.35)	0.071 (1.8)	0.079 (2)	3	Please, consult the tables of standard ratings
SCT01	0.402 (10.2)	0.378 (9.6)	0.300 (7.62)	0.059 (1.5)	0.098 (2.5)	3	
SCT02	0.469 (11.9)	0.449 (11.4)	0.400 (10.16)	0.059 (1.5)	0.098 (2.5)	4	
SCT04	0.650 (16.5)	0.552 (14)	0.539 (13.7)	0.059 (1.5)	0.098 (2.5)	5	
SCT05	0.729 (18.5)	0.670 (17)	0.700 (17.78)	0.059 (1.5)	0.098 (2.5)	6	
SCT06	0.701 (17.8)	0.851 (21.6)	0.600 (15.24)	0.059 (1.5)	0.098 (2.5)	7	
SCT07	0.894 (22.7)	0.654 (16.6)	0.800 (20.32)	0.059 (1.5)	0.098 (2.5)	6	
SCT10	0.520 (13.2)	1.083 (27.5)	0.453 (11.5)	0.083 (2.1)	0.102 (2.6)	10	
SCT12	0.945 (24)	1.598 (40.6)	0.800 (20.32)	0.098 (2.5)	0.098 (2.5)	14	

* Except for the SCT07, tolerance = ± 0.032 in (± 0.8 mm).

** For the SCT12, tolerance = ± 0.012 in (± 0.3 mm).

DERATING RULES

The given voltages in the below capacitance range are the nominal voltages at 125°C.

For higher operating temperatures, the derating rules to be applied on the voltage versus temperature are defined as per the following table :

125°C	200°C	215°C
500V	200V	100V
200V	100V	50V
100V	50V	25V
50V	25V	16V

STANDARD RATINGS

Exxelia size code	2225				3033				3740				5550				Cap. code	
	SCT00				SCT01				SCT02				SCT04					
	U _R	50 V	100 V	200 V	500 V	50 V	100 V	200 V	500 V	50 V	100 V	200 V	500 V	50 V	100 V	200 V		500 V
47nf				0.118 (3)				0.083 (2.1)										473
56				0.118 (3)				0.083 (2.1)										563
68				0.118 (3)				0.083 (2.1)										683
82				0.118 (3)				0.083 (2.1)										823
100			0.039 (1.8)	0.118 (3)			0.083 (2.1)	0.098 (2.5)					0.118 (3)					104
120			0.039 (1.8)	0.118 (3)			0.083 (2.1)	0.098 (2.5)					0.118 (3)					124
150			0.079 (2)	0.252 (6.4)			0.083 (2.1)	0.098 (2.5)					0.118 (3)					154
180	0.039 (1.8)	0.039 (1.8)	0.079 (2)	0.252 (6.4)	0.083 (2.1)	0.083 (2.1)	0.083 (2.1)	0.126 (3.2)					0.083 (2.1)	0.118 (3)				184
220	0.039 (1.8)	0.039 (1.8)	0.098 (2.5)	0.252 (6.4)	0.083 (2.1)	0.083 (2.1)	0.083 (2.1)	0.126 (3.2)					0.083 (2.1)	0.118 (3)				224
270	0.039 (1.8)	0.039 (1.8)	0.098 (2.5)	0.378 (9.6)	0.083 (2.1)	0.083 (2.1)	0.083 (2.1)	0.138 (3.5)					0.083 (2.1)	0.118 (3)			0.098 (2.5)	274
330	0.039 (1.8)	0.039 (1.8)	0.118 (3)	0.378 (9.6)	0.083 (2.1)	0.083 (2.1)	0.083 (2.1)	0.241 (6.1)	0.083 (2.1)	0.083 (2.1)	0.083 (2.1)	0.130 (3.3)					0.098 (2.5)	334
390	0.039 (1.8)	0.039 (1.8)	0.118 (3)	0.504 (12.8)	0.083 (2.1)	0.083 (2.1)	0.083 (2.1)	0.241 (6.1)	0.083 (2.1)	0.083 (2.1)	0.083 (2.1)	0.138 (3.5)					0.098 (2.5)	394
470	0.039 (1.8)	0.039 (1.8)	0.213 (5.4)	0.504 (12.8)	0.083 (2.1)	0.083 (2.1)	0.083 (2.1)	0.272 (6.9)	0.083 (2.1)	0.083 (2.1)	0.083 (2.1)	0.157 (4)					0.118 (3)	474
560	0.079 (2)	0.079 (2)	0.232 (5.9)	0.551 (14)	0.083 (2.1)	0.083 (2.1)	0.098 (2.5)	0.414 (10.5)	0.083 (2.1)	0.083 (2.1)	0.083 (2.1)	0.169 (4.3)					0.118 (3)	564
680	0.079 (2)	0.079 (2)	0.252 (6.4)	0.630 (16)	0.083 (2.1)	0.083 (2.1)	0.118 (3)	0.414 (10.5)	0.083 (2.1)	0.083 (2.1)	0.098 (2.5)	0.276 (7)					0.118 (3)	684
820	0.079 (2)	0.079 (2)	0.319 (8.1)	0.709 (18)	0.083 (2.1)	0.083 (2.1)	0.138 (3.5)	0.548 (13.9)	0.083 (2.1)	0.083 (2.1)	0.098 (2.5)	0.390 (9.9)			0.118 (3)	0.138 (3.5)		824
1µF	0.087 (2.2)	0.087 (2.2)	0.378 (9.6)		0.098 (2.5)	0.098 (2.5)	0.174 (4.4)	0.583 (14.8)	0.083 (2.1)	0.083 (2.1)	0.118 (3)	0.406 (10.3)			0.118 (3)	0.165 (4.2)		105
1.2	0.098 (2.5)	0.098 (2.5)	0.504 (12.8)		0.098 (2.5)	0.098 (2.5)	0.213 (5.4)	0.669 (17.6)	0.083 (2.1)	0.083 (2.1)	0.138 (3.5)	0.552 (14)			0.118 (3)	0.252 (6.4)		125
1.5	0.118 (3)	0.118 (3)	0.551 (14)		0.110 (2.8)	0.110 (2.8)	0.260 (6.6)		0.083 (2.1)	0.083 (2.1)	0.157 (4)	0.630 (16)			0.118 (3)	0.378 (9.6)		155
1.8	0.173 (4.4)	0.173 (4.4)	0.630 (16.4)		0.110 (2.8)	0.110 (2.8)	0.347 (8.8)		0.098 (2.5)	0.098 (2.5)	0.233 (5.9)	0.709 (18)	0.098 (2.5)	0.098 (2.5)	0.118 (3)	0.378 (9.6)		185
2.2	0.197 (5.1)	0.197 (5.1)	0.630 (16.4)		0.110 (2.8)	0.110 (2.8)	0.426 (10.8)		0.098 (2.5)	0.098 (2.5)	0.252 (6.4)	0.709 (18)	0.098 (2.5)	0.098 (2.5)	0.118 (3)	0.378 (9.6)		225
2.7	0.232 (5.9)	0.232 (5.9)			0.130 (3.3)	0.130 (3.3)	0.552 (14)		0.110 (2.8)	0.110 (2.8)	0.252 (6.4)		0.098 (2.5)	0.098 (2.5)	0.138 (3.5)	0.504 (12.8)		275
3.3	0.296 (7.5)	0.296 (7.5)			0.150 (3.8)	0.150 (3.8)	0.591 (15)		0.110 (2.8)	0.110 (2.8)	0.378 (9.6)		0.098 (2.5)	0.098 (2.5)	0.157 (4)	0.583 (14.8)		335
3.9	0.339 (8.6)	0.339 (8.6)			0.237 (6)	0.244 (6.2)			0.130 (3.3)	0.130 (3.3)	0.378 (9.6)		0.098 (2.5)	0.098 (2.5)	0.252 (6.4)	0.662 (16.8)		395
4.7	0.378 (9.6)	0.378 (9.6)			0.237 (6)	0.252 (6.4)			0.138 (3.5)	0.138 (3.5)	0.504 (12.8)		0.118 (3)	0.118 (3)	0.378 (9.6)			475
5.6	0.484 (12.3)	0.484 (12.3)			0.276 (7)	0.283 (7.2)			0.142 (3.6)	0.142 (3.6)	0.630 (16)		0.118 (3)	0.118 (3)	0.378 (9.6)			565
6.8	0.504 (12.8)	0.504 (12.8)			0.315 (8)	0.323 (8.2)			0.185 (4.7)	0.185 (4.7)	0.709 (18)		0.118 (3)	0.118 (3)	0.434 (11)			685
8.2	0.630 (16)	0.630 (16)			0.434 (11)	0.441 (11.2)			0.284 (7.2)	0.354 (9)			0.138 (3.5)	0.138 (3.5)	0.438 (11.1)			825
10					0.473 (12)	0.480 (12.2)			0.292 (7.4)	0.354 (9)			0.150 (3.8)	0.150 (3.8)	0.497 (12.6)			106
12					0.552 (14)	0.559 (14.4)			0.414 (10.5)	0.472 (12)			0.252 (6.4)	0.252 (6.4)	0.630 (16)			126
15									0.438 (11.1)	0.492 (12.5)			0.284 (7.2)	0.319 (8.1)				156
18									0.583 (14.8)	0.591 (15)			0.304 (7.7)	0.394 (10.8)				186
22									0.598 (15.2)	0.598 (15.2)			0.315 (8)	0.504 (12.8)				226
27													0.461 (11.7)	0.504 (12.8)				276
33													0.473 (12)	0.583 (14.8)				336
39													0.630 (16)	0.662 (16.8)				396

* Consult us - The height Hmax in inches (in mm) for the SCT Series is indicated in the cells.

High Temperature Stacked Capacitors

SCT Series

STANDARD RATINGS

Exxelia size code	6560				6080 / 8060				45107				45214				Cap. code
	SCT05				SCT06 / SCT07				SCT10				SCT11				
U _R	50 V	100 V	200 V	500 V	50 V	100 V	200 V	500 V	50 V	100 V	200 V	500 V	50 V	100 V	200 V	500 V	
270nf				0.098 (2.5)													274
330				0.098 (2.5)													334
390				0.098 (2.5)													394
470				0.098 (2.5)				0.118 (3)									474
560			0.098 (2.5)	0.098 (2.5)				0.118 (3)									564
680			0.098 (2.5)	0.098 (2.5)				0.118 (3)				0.138 (3.5)					684
820			0.098 (2.5)	0.118 (3)				0.118 (3)			0.118 (3)	0.138 (3.5)					824
1 μF	0.098 (2.5)	0.098 (2.5)	0.098 (2.5)	0.118 (3)				0.118 (3)	0.118 (3)	0.118 (3)	0.118 (3)	0.150 (3.8)					105
1.2	0.098 (2.5)	0.098 (2.5)	0.098 (2.5)	0.138 (3.5)				0.138 (3.5)	0.118 (3)	0.118 (3)	0.118 (3)	0.150 (3.8)					125
1.5	0.098 (2.5)	0.098 (2.5)	0.098 (2.5)	0.157 (4)			0.118 (3)	0.157 (4)	0.118 (3)	0.118 (3)	0.118 (3)	0.252 (6.4)					155
1.8	0.098 (2.5)	0.098 (2.5)	0.098 (2.5)	0.177 (4.5)			0.118 (3)	0.177 (4.5)	0.118 (3)	0.118 (3)	0.118 (3)	0.252 (6.4)					185
2.2	0.098 (2.5)	0.098 (2.5)	0.098 (2.5)	0.272 (6.9)			0.118 (3)	0.272 (6.9)	0.118 (3)	0.118 (3)	0.138 (3.5)	0.252 (6.4)					225
2.7	0.098 (2.5)	0.098 (2.5)	0.118 (3)	0.312 (7.9)			0.118 (3)	0.378 (9.6)	0.118 (3)	0.118 (3)	0.150 (3.8)	0.292 (7.4)				*	275
3.3	0.098 (2.5)	0.098 (2.5)	0.118 (3)	0.331 (8.4)			0.118 (3)	0.398 (10.1)	0.118 (3)	0.118 (3)	0.157 (4)	0.378 (9.6)				*	335
3.9	0.098 (2.5)	0.098 (2.5)	0.138 (3.5)	0.438 (11.1)	0.118 (3)	0.118 (3)	0.138 (3.5)	0.504 (12.8)	0.118 (3)	0.118 (3)	0.213 (5.4)	0.504 (12.8)				*	395
4.7	0.098 (2.5)	0.098 (2.5)	0.157 (4)	0.497 (12.6)	0.118 (3)	0.118 (3)	0.157 (4)	0.583 (14.8)	0.118 (3)	0.118 (3)	0.233 (5.9)	0.583 (14.8)				*	475
5.6	0.098 (2.5)	0.098 (2.5)	0.233 (5.9)	0.662 (16.8)	0.118 (3)	0.118 (3)	0.252 (6.4)	0.583 (14.8)	0.118 (3)	0.118 (3)	0.252 (6.4)	0.583 (14.8)				*	565
6.8	0.098 (2.5)	0.098 (2.5)	0.252 (6.4)	0.819 (20.8)	0.118 (3)	0.118 (3)	0.252 (6.4)	0.661 (16.8)	0.118 (3)	0.118 (3)	0.319 (8.1)	0.662 (16.8)				*	685
8.2	0.118 (3)	0.118 (3)	0.359 (9.1)		0.118 (3)	0.118 (3)	0.378 (9.6)	0.740 (18.8)	0.118 (3)	0.118 (3)	0.378 (9.6)				*	*	825
10	0.118 (3)	0.118 (3)	0.378 (9.6)		0.138 (3.5)	0.138 (3.5)	0.378 (9.6)		0.138 (3.5)	0.138 (3.5)	0.378 (9.6)				*	*	106
12	0.138 (3.5)	0.138 (3.5)	0.504 (12.8)		0.138 (3.5)	0.138 (3.5)	0.504 (12.8)		0.138 (3.5)	0.138 (3.5)	0.504 (12.8)			*	*	*	126
15	0.157 (4)	0.157 (4)	0.583 (14.8)		0.138 (3.5)	0.138 (3.5)	0.504 (12.8)		0.252 (6.4)	0.252 (6.4)	0.504 (12.8)			*	*	*	156
18	0.252 (6.4)	0.252 (6.4)			0.146 (3.7)	0.146 (3.7)	0.630 (16)		0.252 (6.4)	0.252 (6.4)	0.661 (16.8)			*	*	*	186
22	0.252 (6.4)	0.252 (6.4)			0.252 (6.4)	0.291 (7.4)	0.740 (18.8)		0.378 (9.6)	0.378 (9.6)				*	*	*	226
27	0.312 (7.9)	0.378 (9.6)			0.252 (6.4)	0.323 (8.2)	0.740 (18.8)		0.378 (9.6)	0.378 (9.6)				*	*	*	276
33	0.331 (8.4)	0.378 (9.6)			0.280 (7.1)	0.413 (10.5)			0.504 (12.8)	0.504 (12.8)				*	*	*	336
39	0.457 (11.6)	0.504 (12.8)			0.378 (9.6)	0.441 (11.2)			0.504 (12.8)	0.504 (12.8)				*	*	*	396
47	0.497 (12.6)	0.504 (12.8)			0.378 (9.6)	0.465 (11.8)			0.591 (15)	0.591 (15)				*	*	*	476
56	0.662 (16.8)	0.669 (17)			0.457 (11.6)	0.472 (12)			0.591 (15)	0.591 (15)				*	*	*	566
68					0.583 (14.8)	0.591 (15)								*	*	*	686
82														*		*	826
100														*		*	107
120														*		*	127

* Consult us - The height Hmax in inches (in mm) for the SCT Series is indicated in the cells.

STANDARD RATINGS

Exxelia size code	80150				125205				Cap. code
	SCT12				SCT18				
U _R	50 V	100 V	200 V	500 V	50 V	100 V	200 V	500 V	
680nf									684
820									824
1 μF									105
1.2									125
1.5									155
1.8									185
2.2									225
2.7				0.157 (4)					275
3.3				0.157 (4)					335
3.9				0.157 (4)					395
4.7				0.157 (4)					475
5.6				0.315 (8)					565
6.8				0.315 (8)					685
8.2			0.157 (4)	0.315 (8)				*	825
10			0.157 (4)	0.315 (8)				*	106
12			0.315 (8)	0.472 (12)				*	126
15			0.315 (8)	0.472 (12)				*	156
18		*	0.315 (8)	0.630 (16)				*	186
22		*	0.315 (8)	*			*	*	226
27		*	0.472 (12)	*			*	*	276
33		0.157 (4)	0.472 (12)	*			*	*	336
39	0.157 (4)	0.157 (4)	0.630 (16)			*	*	*	396
47	0.157 (4)	0.315 (8)	*			*	*	*	476
56	0.315 (8)	0.315 (8)	*			*	*	*	566
68	0.315 (8)	0.315 (8)				*	*		686
82	0.315 (8)	0.315 (8)			*	*	*		826
100	0.315 (8)	0.472 (12)			*	*	*		107
120	0.472 (12)	0.472 (12)			*	*			127
150	0.472 (12)	0.630 (16)			*	*			157
180	0.630 (16)				*	*			187
220					*	*			227
270					*				277
330					*				337
390					*				397

* Consult us - The height Hmax in inches (in mm) for the SCT Series is indicated in the cells.

General Information

High temperature capacitors are made of class 1 or class 2 ceramic dielectrics featuring special compositions based upon high purity oxides to reduce ionic conduction inherent to the presence of atoms such as sodium.

In addition, all quality controls carried out at intermediate and final production stages (lot acceptance test under U_{RC} and insulation resistance measurement at operating temperature) are the assurance of enhanced reliability.

High temperature capacitors include :

- chip class 1 (CEC 203 to CEC 233) and class 2 (CNC 203 to 233),
- encapsulated radial leads class 1 and 2 (TCE / TCN 201 to 204),
- encapsulated axial leads class 1 and 2 (TCE / TCN 252 to 254),
- selfprotected radial leads class 1 and 2 (TCE / TCN 212 to 216) and radial leads class 1 and 2 (TCE / TCN 263).

Mechanical stress is eliminated with replacement of epoxy by selfprotected ceramic. This also allows the increase of the capacitance ranges and improves the reliability.

- high voltage varnished capacitors (TCH 279 to 285)
- high capacitance value SCT Series.

They are highly recommended for operation at temperatures of up to 200°C. Capacitors specifically designed for higher operating temperatures (e.g. TCE / TCN 212 to 216 and TCE / TCN 263 to 266) are also available.

High temperature capacitors are made of class 1 or class 2 ceramic dielectrics featuring special compositions based upon high purity oxides to reduce ionic conduction inherent to the presence of atoms such as sodium.

TYPICAL CURVES: CE / CN Series, TCE / TCN Series, TCH Series

NPO: TYPICAL CAPACITANCE VARIATION VERSUS TEMPERATURE

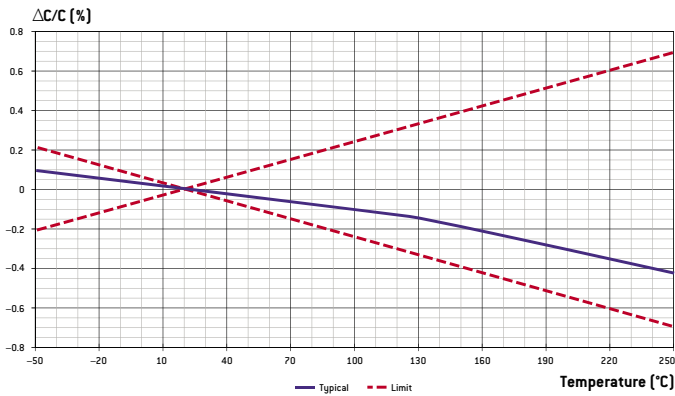

NPO: TYPICAL INSULATION RESISTANCE VERSUS TEMPERATURE

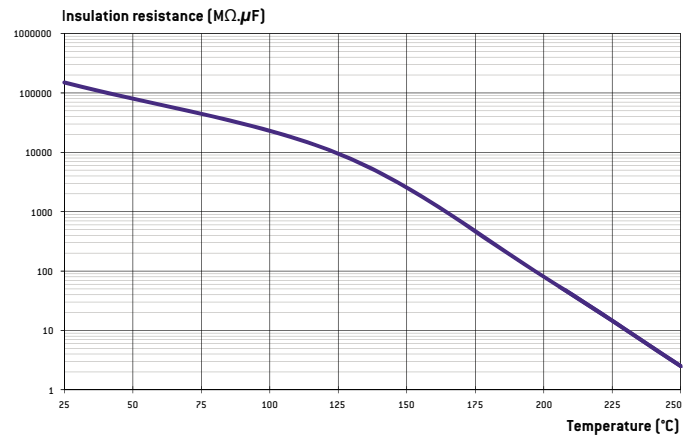

X7R: TYPICAL CAPACITANCE VARIATION VERSUS TEMPERATURE

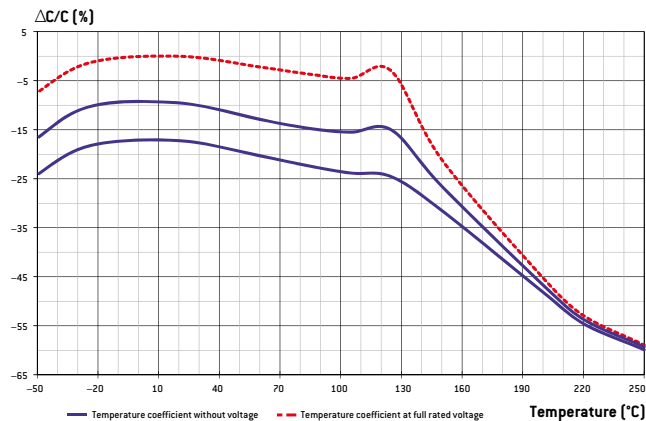

X7R: TYPICAL INSULATION RESISTANCE VERSUS TEMPERATURE



General Information

TYPICAL CURVES: SCT Series

$\Delta C/C$ VERSUS APPLIED VOLTAGE AND RATED VOLTAGE (U_R)

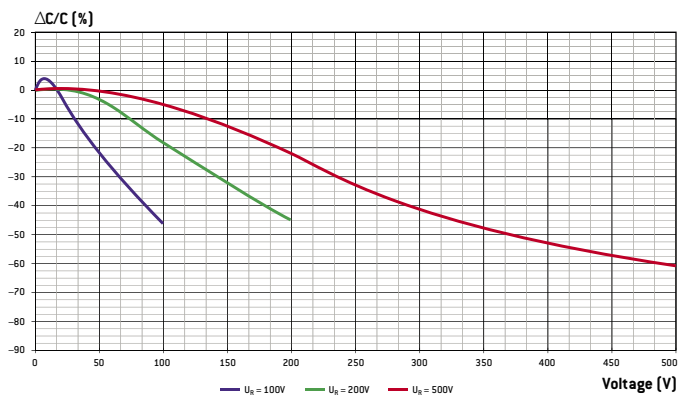

CAPACITANCE VERSUS TEMPERATURE

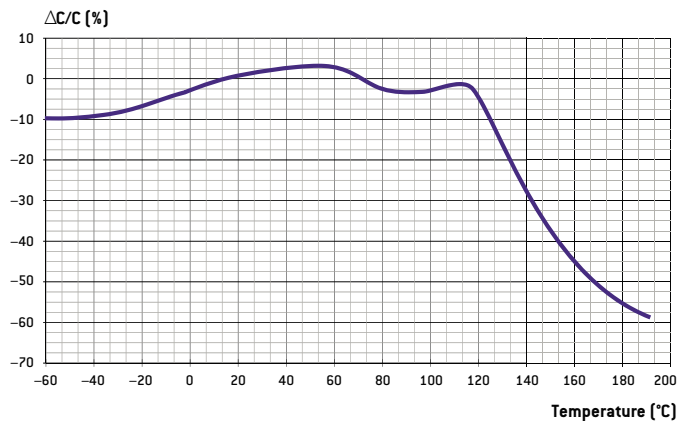

DIELECTRIC LOSSES VERSUS TEMPERATURE

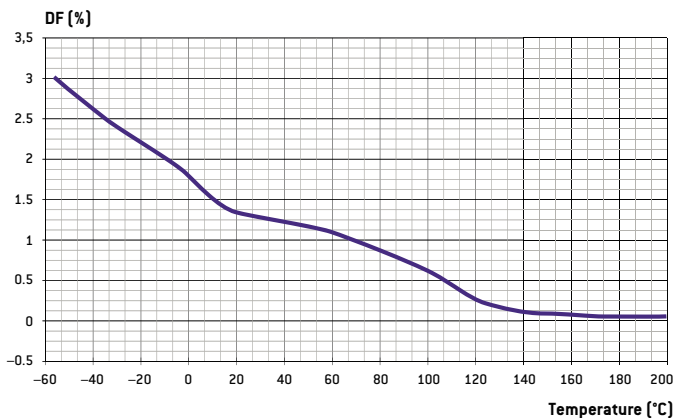

INSULATION RESISTANCE VERSUS TEMPERATURE

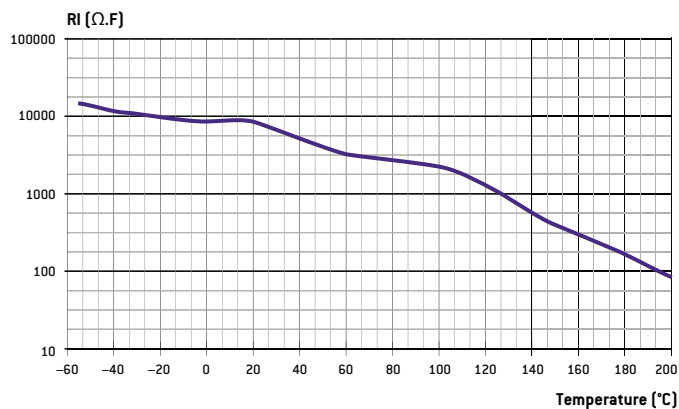

HIGH TEMPERATURE

Ceramic Capacitors Technology

MLCC STRUCTURE

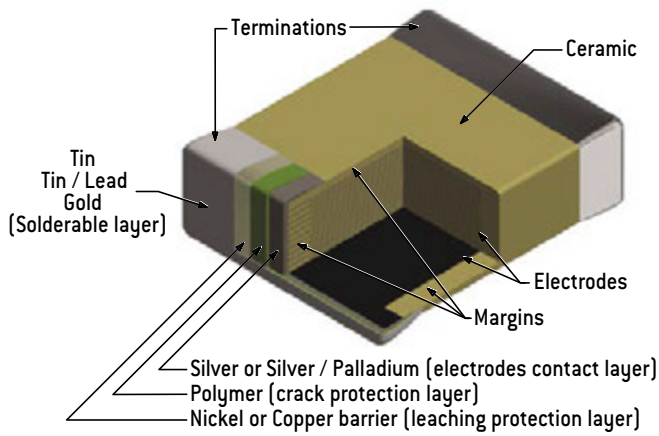

EQUIVALENT CIRCUIT

Capacitor is a complex component combining resistive, inductive and capacitive phenomena. A simplified schematic for the equivalent circuit is:

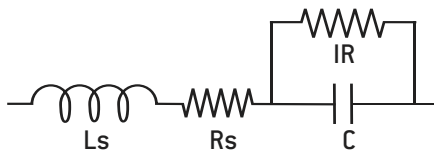

DIELECTRIC CHARACTERISTICS

Insulation Resistance (IR) is the resistance measured under DC voltage across the terminals of the capacitor and consists principally of the parallel resistance shown in the equivalent circuit. As capacitance values and hence the area of dielectric increases, the IR decreases and hence the product (C x IR) is often specified in $\Omega \cdot F$ or $M\Omega \cdot \mu F$.

The Equivalent Series Resistance (ESR) is the sum of the resistive terms which generate heating when capacitor is used under AC voltage at a given frequency (f).

Dissipation factor (DF) is the ration of the apparent power input will turn to heat in the capacitor:

$$DF = 2\pi f C ESR$$

When a capacitor works under AC voltage, **heat power loss (P)**, expressed in Watt, is equal to:

$$P = 2\pi f C V_{rms}^2 DF$$

The series inductance (Ls) is due to the currents running through the electrodes. It can distort the operation of the capacitor at high frequency where the **impedance (Z)** is given as:

$$Z = R_s + j (L_s \cdot \omega - 1 / (C \cdot \omega)) \text{ with } \omega = 2\pi f$$

When frequency rises, the capacitive component of capacitors is gradually canceled up to the resonance frequency, where :

$$Z = R_s \text{ and } L_s C \cdot \omega^2 = 1$$

Above this frequency the capacitor behaves like an inductor.

	P100	NPO	N2200 (C4xx)	BX	2C1	X7R
Dielectric material	Porcelain	Magnesium titanate or Neodymium baryum titanate	Barium zirconate titanate	Baryum titanate (BaTiO ₃)		
Dielectric constant	15 – 18	20 – 85	450	2,000 – 5,000		
Electrode technology	PME (Precious Metal Electrodes): Ag/Pd					
Capacitance variation between –55°C and +125°C without DC voltage	(100 ± 30)ppm/°C	(0 ± 30)ppm/°C	(–2,200 ± 500) ppm/°C	± 15%	± 20%	± 15%
Capacitance variation between –55°C and +125°C with DC rated voltage			0 -15%	15% –25%	20% –30%	Not applicable
Piezo-electric effect	None		None	Yes		
Dielectric absorption	None		Few %	Few %		
Thermal shock sensitive	+		+	++		

Ceramic Capacitors Technology

MANUFACTURING STEPS

SLIP CASTING



A slurry, a mix of ceramic powder, binder and solvents, is poured onto conveyor belt inside a drying oven, resulting in a dry ceramic sheet.

ELECTRODE SCREEN PRINTING

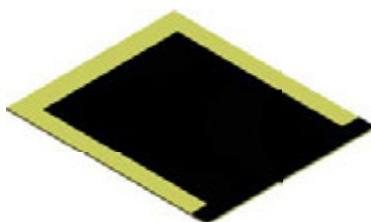

The electrode ink, made from a metal powder mixed with solvents, is printed onto the ceramic sheets using a screen printing process.

STACKING

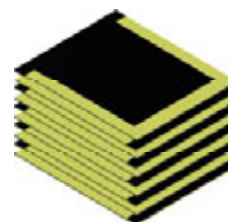

The sheets with electrode printed are stacked to create a multilayer structure.

TERMINATIONS

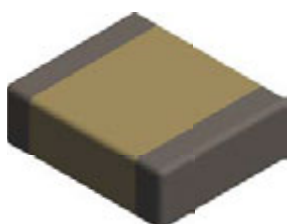

Each terminal of the capacitor is dipped in the termination ink, mix of metal powder, solvents and glass frit and the parts are fired in an oven.

SINTERING

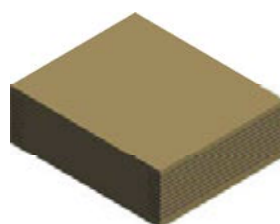

The parts are sintered in an oven with a precise temperature profile which is very important to the characteristics of the capacitors.

PRESSING

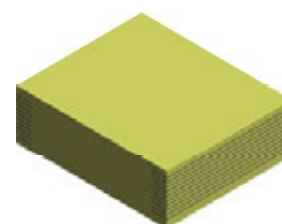

Pressure is applied to the stack to fuse all the separate layers, this created a monolithic structure.

TERMINATIONS PLATING

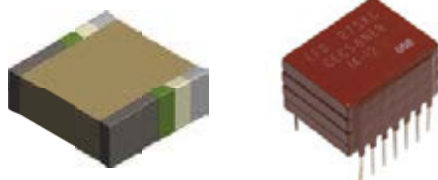

Stacking + leads soldering + encapsulation
[see pages 10-11]

FINAL TESTING

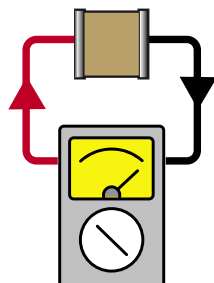

PACKAGING



User Guide

SMD TERMINATIONS

NON RoHS COMPLIANT	Code	RoHS COMPLIANT	Code	Recommended mounting process							Storage [months]*
				Magnetic	Epoxy bonding	Iron soldering	Wave soldering	Vapor phase soldering	Infrared soldering	Wire bonding	
Ag	Q	Ag	QW / P	No	•	•	•	•			18
Ag/Pd/Pt	-	Ag/Pd/Pt	W / A	No	•	•	•				24
Ag + Ni + dipped Sn/Pb 60/40	T**	-	-	No		•	•	•	•		24
Ag/Pd/Pt + dipped Sn/Pb 60/40	H	Ag/Pd/Pt + dipped Sn	HW	No		•					24
Ag + Ni + electrolytic Sn/Pb 95/5	C	Ag + Ni + electrolytic Sn	CW / S	Yes		•	•	•	•		18
Ag + Ni + electrolytic Sn/Pb 60/40	D	-	-	Yes		•	•	•	•		18
-	-	Ag + Cu + electrolytic Sn	C***	No		•	•	•	•		18
Ag + Ni + dipped Sn/Pb 60/40	E	Ag + Ni + electrolytic Sn	EW	Yes		•	•				24
Ag + Ni + Au	G	Ag + Ni + Au	GW	Yes	•	•	•	•	•	•	36
Ag + Polymer + Ni + Sn/Pb 95/5	YC	Ag + Polymer + Ni + Sn	YCW	Yes		•	•	•	•		18
Ag + Polymer + Ni + Sn/Pb 60/40	YD	-	-	Yes		•	•	•	•		18
Ag + Polymer + Ni + Au	YG	Ag + Polymer + Ni + Au	YGW	Yes	•	•	•	•	•	•	36

Nickel (Ni) or Copper (Cu) barriers amplify thermal shock and are not recommended for chip sizes larger than 3030.

* Storage must be in a dry environment at a temperature of 20°C with a relative humidity below 50%, or preferably in a package enclosing a desiccant.

** Maintenance only.

*** Non magnetic chips series only.

SMD ENVIRONMENTAL TESTS

Ceramic chip capacitors for SMD are designed to meet test requirements of **CECC 32100** and **NF C 93133** standards as specified below in compliance with **NF C 20700** and **IEC 68** standards:

- Solderability: **NF C 20758**, 260°C, bath 62/36/2.
- Adherence: 5N force.
- Vibration fatigue test: **NF C 20706**, 20 g, 10 Hz to 2,000 Hz, 12 cycles of 20 minutes each.
- Rapid temperature change: **NF C 20714**, -55°C to + 125°C, 5 cycles.
- Combined climatic test: **IEC 68-2-38**.
- Damp heat: **NF C 20703**, 93 %, H.R., 40°C.
- Endurance test: 1,000 hours, 1.5 U_{RC}, 125°C.

STORAGE OF CHIP CAPACITORS

TINNED OR NON TINNED CHIP CAPACITORS

Storage must be in a dry environment at a temperature of 20°C with a relative humidity below 50 %, or preferably in a packaging enclosing a desiccant.

STORAGE IN INDUSTRIAL ENVIRONMENT:

- 2 years for tin dipped chip capacitors,
- 18 months for tin electroplated chip capacitors,
- 2 years for non tinned chip capacitors,
- 3 years for gold plated chip capacitors.

STORAGE IN CONTROLLED NEUTRAL NITROGEN ENVIRONMENT:

- 4 years for tin dipped or electroplated chip capacitors,
- 4 years for non tinned chip capacitors,
- 5 years for gold plated chip capacitors.

Storage duration should be considered from delivery date and not from batch manufacture date. The tests carried out at final acceptance stage [solderability, susceptibility to solder heat] enable to assess the compatibility to surface mounting of the chips.

User Guide

LEAD STYLES

SURFACE MOUNTING

DIL LEADS

P style



PL style



L style

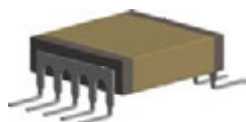

J style

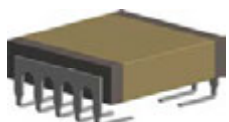

RIBBON LEADS

Micro-strip (type 1)
Short Micro-strip (type 1S)

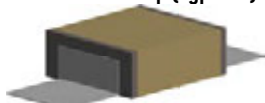

Axial (Type 2)

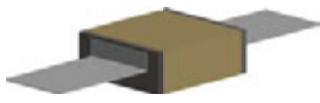

Radial (Type 3)



R style

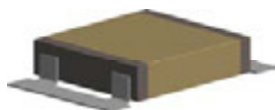

RX style



RJ style

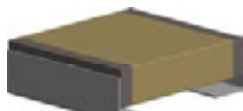

Please contact Exxelia sales for any lead configuration not shown.

TROUGH-HOLE MOUNTING

AXIAL AND RADIAL

Radial leads (Type 6)



Radial leads (4 leads)

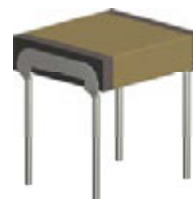

Axial leads (Type 7)

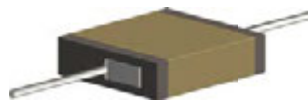

DIL leads: N style

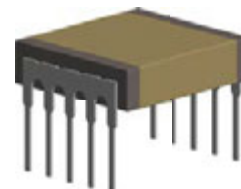

ENCAPSULATION STYLES

Ceramic encapsulation
(selfprotected)



Varnish

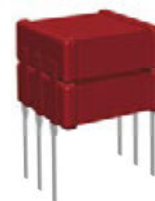

Conformal coating



Molding



User Guide

SOLDERING ADVICES FOR REFLOW SOLDERING

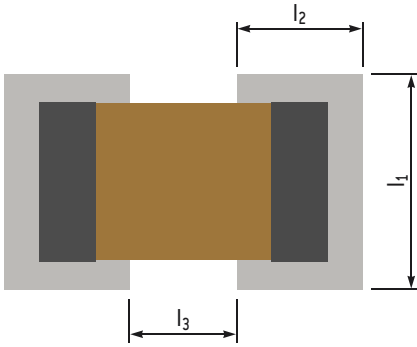

Large chips above size 2225 are not recommended to be mounted on epoxy board due to thermal expansion coefficient mismatch between ceramic capacitor and epoxy. Where larger sizes are required, it is recommended to use components with ribbon or other adapted leads so as to absorb thermo-mechanical strains.

Dimensions in inches (in mm)	Reflow soldering						Wave soldering					
	l ₁		l ₂		l ₃		l ₁		l ₂		l ₃	
0402	0.043	(1.1)	0.035	(0.9)	0.012	(0.3)	0.043	(1.1)	0.047	(1.2)	0.012	(0.3)
0403	0.055	(1.4)	0.035	(0.9)	0.012	(0.3)	0.055	(1.4)	0.047	(1.2)	0.012	(0.3)
0504	0.063	(1.6)	0.051	(1.3)	0.016	(0.4)	0.063	(1.6)	0.063	(1.6)	0.016	(0.4)
0603	0.055	(1.4)	0.059	(1.5)	0.02	(0.5)	0.055	(1.4)	0.071	(1.8)	0.02	(0.5)
0805	0.073	(1.85)	0.065	(1.65)	0.024	(0.6)	0.073	(1.85)	0.077	(1.95)	0.024	(0.6)
0907	0.094	(2.4)	0.065	(1.65)	0.035	(0.9)	0.094	(2.4)	0.077	(1.95)	0.035	(0.9)
1005	0.073	(1.85)	0.067	(1.7)	0.039	(1)	0.073	(1.85)	0.079	(2)	0.039	(1)
1206	0.083	(2.1)	0.067	(1.7)	0.059	(1.5)	0.083	(2.1)	0.079	(2)	0.059	(1.5)
1210	0.118	(3)	0.069	(1.75)	0.059	(1.5)	0.118	(3)	0.081	(2.05)	0.059	(1.5)
1605	0.073	(1.85)	0.071	(1.8)	0.087	(2.2)	0.073	(1.85)	0.083	(2.1)	0.087	(2.2)
1806	0.087	(2.2)	0.073	(1.85)	0.102	(2.6)	0.087	(2.2)	0.085	(2.15)	0.102	(2.6)
1812	0.152	(3.85)	0.073	(1.85)	0.102	(2.6)	0.152	(3.85)	0.085	(2.15)	0.102	(2.6)
1825	0.281	(7.15)	0.073	(1.85)	0.102	(2.6)	0.281	(7.15)	0.085	(2.15)	0.102	(2.6)
2210	0.13	(3.3)	0.079	(2)	0.146	(3.7)	0.13	(3.3)	0.091	(2.3)	0.146	(3.7)
2220	0.228	(5.8)	0.079	(2)	0.146	(3.7)	0.228	(5.8)	0.091	(2.3)	0.146	(3.7)
2225	0.281	(7.15)	0.079	(2)	0.146	(3.7)	0.281	(7.15)	0.091	(2.3)	0.146	(3.7)

RECOMMENDED FOOTPRINT FOR SMD CAPACITORS

Ceramic is by nature a material which is sensitive both thermally and mechanically. Stresses caused by the physical and thermal properties of the capacitors, substrates and solders are attenuated by the leads.

Wave soldering is unsuitable for sizes larger than 2220 and for the higher ends of capacitance ranges due to possible thermal shock (capacitance values given upon request).

Infrared and vapor phase reflow, are preferred for high reliability applications as inherent thermo-mechanical strains are lower than those inherent to wave soldering.

Whatever the soldering process is, it is highly recommended to apply a thermal cycle, see hereafter our recommended soldering profile:

RECOMMENDED VAPOR PHASE REFLOW PROFILE

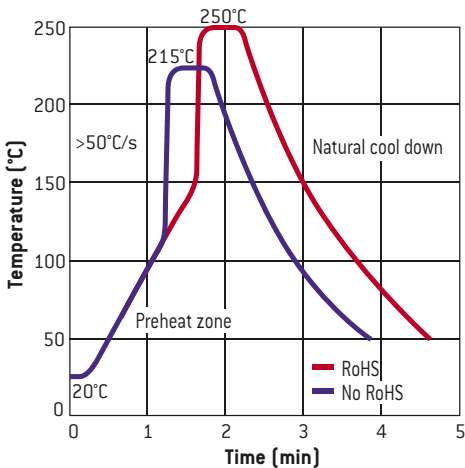

RECOMMENDED IR REFLOW PROFILE

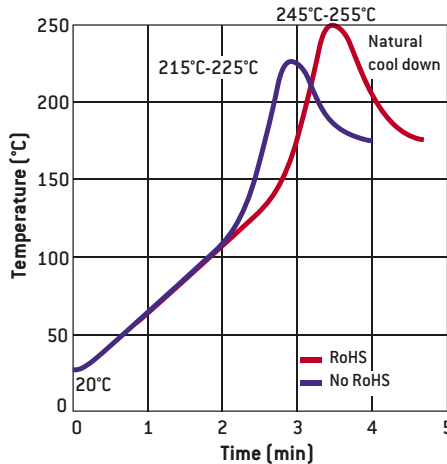

RECOMMENDED WAVE SOLDERING PROFILE

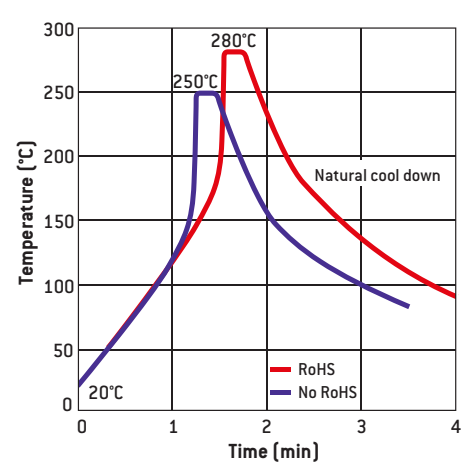

SOLDERING ADVICES FOR IRON SOLDERING

Attachment with a soldering iron is discouraged due to ceramic brittleness and the process control limitations. In the event that a soldering iron must be used, the following precautions should be observed:

- Use a substrate with chip footprints big enough to allow putting side by side one end of the capacitor and the iron tip without any contact between this tip and the component,
- place the capacitor on this footprint,

- heat the substrate until the capacitor's temperature reaches 150°C minimum (preheating step, maximum 1°C per second),
- place the hot iron tip (a flat tip is preferred) on the footprint **without touching the capacitor**. Use a regulated iron with a 30 watts maximum power. The recommended temperature of the iron is 270 ± 10°C. The temperature gap between the capacitor and the iron tip must not exceed 120°C,

User Guide

- leave the tip on the footprint for a few seconds in order to increase locally the footprint's temperature,
- use a cored wire solder and put it down on the iron tip. In a preferred way use Sn/Pb/Ag 62/36/2 alloy,
- wait until the solder fillet is formed on the capacitor's termination,
- take away iron and wire solder,

- wait a few minutes so that the substrate and capacitor come back down to the preheating temperature,
- solder the second termination using the same procedure as the first,
- let the soldered component cool down slowly to avoid any thermal shock.

PACKAGING

TAPE AND REEL

The films used on the reels correspond to standard IEC 60286-3. Films are delivered on reels in compliance with document IEC 286-3 dated 1991.

Minimum quantity is 250 chips.

Maximum quantities per reel are as follows:

- Super 8 reel - Ø 180: 2,500 chips.
- Super 8 reel - Ø 330: 10,000 chips.
- Super 12 reel - Ø 180: 1,000 chips.

Reel marking complies with CECC 32100 standard:

- Model.
- Rated capacitance.
- Capacitance tolerance.
- Rated voltage.
- Batch number.

TRAY PACKAGES

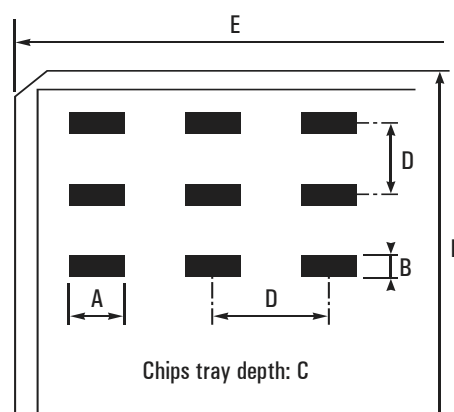

DIMENSIONAL CHARACTERISTICS OF CHIPS TRAY PACKAGES

Sizes	Nr. of chips/ package	Oriented chips	Dimensions in inches (in mm)				
			A	B	C	D	E
0402	100	No	0 0.112 [0 3.02]		0.065 [1.65]	0.167 [4.24]	2 [50.8]
0403	100	No	0 0.112 [0 3.02]		0.065 [1.65]	0.167 [4.24]	2 [50.8]
0504	100	Yes	0.059 [1.5]	0.045 [1.14]	0.035 [0.89]	0.167 [4.24]	2 [50.8]
0603	340	Yes	0.1 [2.54]	0.06 [1.52]	0.045 [1.14]	0.167 [4.24]	2 [50.8]
0805	100	Yes	0.1 [2.54]	0.06 [1.52]	0.045 [1.14]	0.167 [4.24]	2 [50.8]
1206	100	No	0.14 [3.56]	0.14 [3.56]	0.06 [1.52]	0.167 [4.24]	2 [50.8]
1210	100	Yes	0.14 [3.56]	0.14 [3.56]	0.06 [1.52]	0.167 [4.24]	2 [50.8]
1812	100	No	0.25 [6.35]	0.25 [6.35]	0.13 [3.3]	0.345 [8.76]	4 [101.6]
	25	Yes	0.24 [6.1]	0.265 [6.73]	0.07 [1.78]	0.345 [8.76]	2 [50.8]
2220	100	Yes	0.25 [6.35]	0.25 [6.35]	0.13 [3.3]	0.345 [8.76]	4 [101.6]
	25	Yes	0.24 [6.1]	0.265 [6.73]	0.07 [1.78]	0.345 [8.76]	2 [50.8]

HIGH Q CAPACITORS TAPE AND REEL PACKAGING SPECIFICATIONS

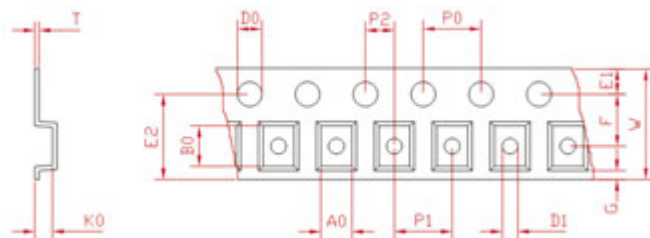

Sizes	Type [1]	W±0.3 inches (mm)	F ±0.05 inches (mm)	P1 ±0.1 inches (mm)	T max. inches (mm)	Reel Size inches (mm)	Quantity per Reel
A [0505]	H	0,315 [8]	0,138 [3.5]	0,157 [4]	0,010 [0,25]	7,087 [180]	3'000
A [0505]	V	0,315 [8]	0,138 [3.5]	0,157 [4]	0,010 [0,25]	7,087 [180]	3'000
S [0603]	H	0,315 [8]	0,138 [3.5]	0,157 [4]	0,016 [0,4]	7,087 [180]	4'000
F [0805]	H	0,315 [8]	0,138 [3.5]	0,157 [4]	0,016 [0,4]	7,087 [180]	4'000
B [1111]	H	0,315 [8]	0,138 [3.5]	0,157 [4]	0,012 [0,3]	7,087 [180]	1'000
B [1111]	V	0,315 [8]	0,138 [3.5]	0,157 [4]	0,010 [0,25]	7,087 [180]	1'000
X [2225]	H	0,472 [12]	0,138 [5.5]	0,472 [12]	0,018 [0,45]	12,992 [330]	500
E [4040]	H	0,945 [24]	0,453±0,004 [11.5±0.1]	0,630 [16]	0,018 [0,45]	12,992 [330]	700
E [4040]	V	1,260 [32]	0,559±0,004 [14.2±0.1]	0,945 [24]	0,022 [0,55]	15 [381]	350

[1]: Horizontal (H) or Vertical (V) orientation in cavities.

User Guide

EIA STANDARD CAPACITANCE VALUES

Following EIA standard, the values and multiples that are indicated in the chart below can be ordered. E48, E96 series and intermediary values are available upon request.

E6 (± 20%)	E12 (± 10%)	E24 (± 5%)
10	10	10
		11
		12
15	12	13
		15
		16
22	15	18
		20
		22
33	18	24
		27
		30
47	22	33
		36
		39
68	33	43
		47
		51
100	47	56
		62
		68
150	68	75
		82
		91

EIA CAPACITANCE CODE

The capacitance is expressed in three digit codes and in units of pico Farads (pF). The first and second digits are significant figures of the capacitance value and the third digit identifies the multiplier.

For capacitance value < 10pF, R designates a decimal point.
See examples below:

EIA code	Capacitance value		
	in pF	in nF	in μ F
2R2	2.2	0.0022	0.0000022
6R8	6.8	0.0068	0.0000068
220	22	0.022	0.000022
470	47	0.047	0.000047
181	180	0.18	0.00018
221	220	0.22	0.00022
102	1,000	1	0.001
272	2,700	2.7	0.0027
123	12,000	12	0.012
683	68,000	68	0.068
124	120,000	120	0.12
564	560,000	560	0.56
335	3,300,000	3,300	3.3
825	8,200,000	8,200	8.2
156	15,000,000	15,000	15
686	68,000,000	68,000	68
107	100,000,000	100,000	100
227	220,000,000	220,000	220

PART MARKING VOLTAGE CODES

Use the following voltage code chart for part markings:

Voltage (V)	Code	Letter code
25	250	A
40	400	B
50	500	C
63	630	D
100	101	E
200	201	G
250	251	H
400	401	K
500	501	L
1,000	102	M
2,000	202	P
3,000	302	R
4,000	402	S
5,000	502	T
7,500	752	U
10,000	103	W

PART MARKING TOLERANCE CODES

Use the following tolerance code chart for part markings:

Tolerance	Letter code
± 0.25pF	CU
± 0.5pF	DU
± 1pF	FU
± 1%	F
± 2%	G
± 5%	J
± 10%	K
± 20%	M

User Guide

RELIABILITY LEVELS

Exxelia proposes different reliability levels for the ceramic capacitors for both NPO and X7R ceramics.

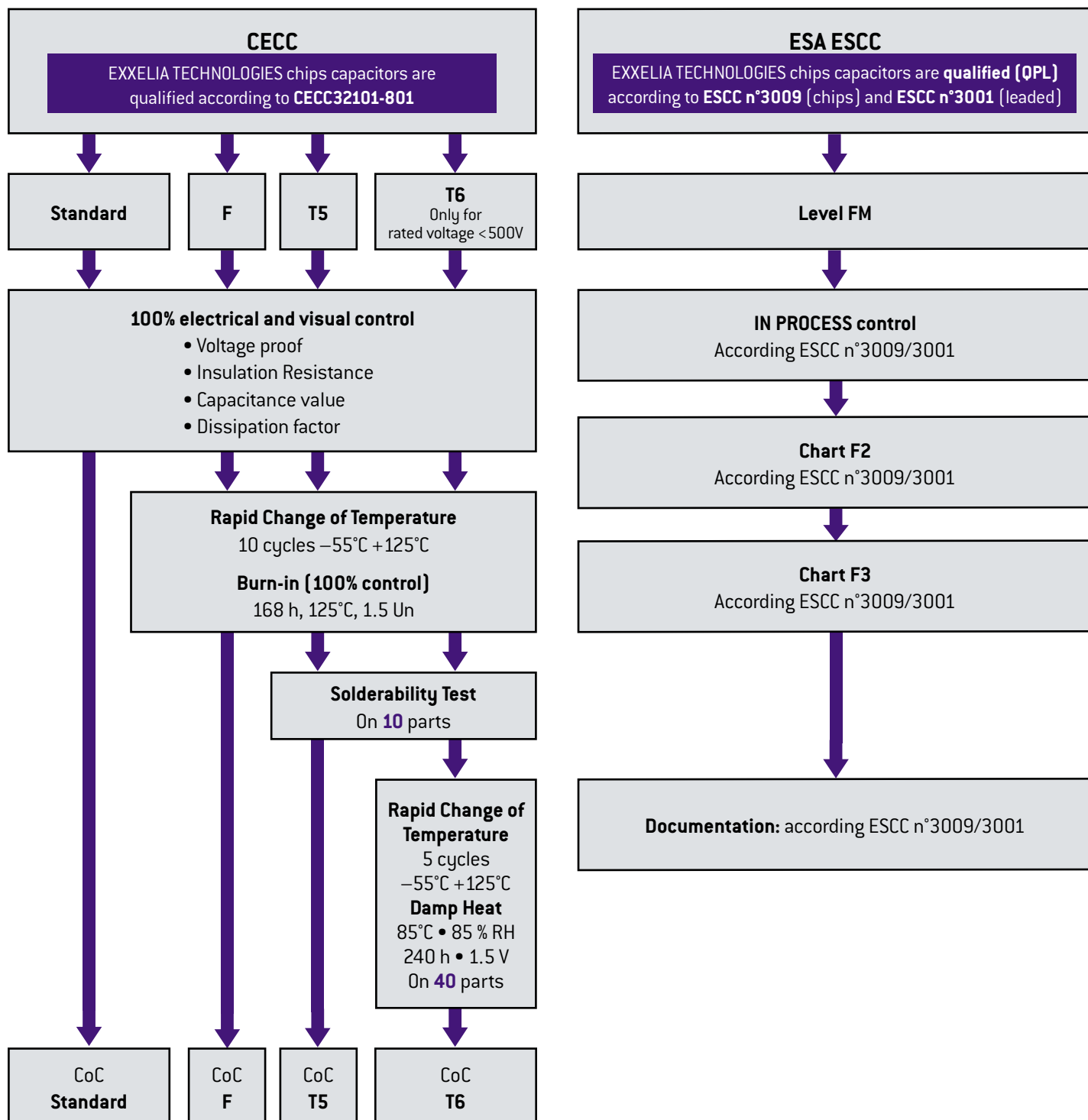

As the world's leading manufacturer of specific passive components, we stand apart through our ability to quickly evaluate the application specific engineering challenges and provide a cost-effective and efficient solutions.

For requirements that cannot be met by catalog products, we offer leading edge solutions in custom configuration: custom geometries, packaging, characteristics, all is possible thanks to our extensive experience and robust development process, while maintaining the highest level of reliability.

Where necessary, special testing is done to verify requirements, such as low dielectric absorption, ultra-high insulation resistance, low dissipation factor, stability under temperature cycling or under specified environmental conditions, etc.

HIGH CAPACITANCE

- High energy density
- Specific case sizes
- Specific shape of connections (high resistance to vibrations)

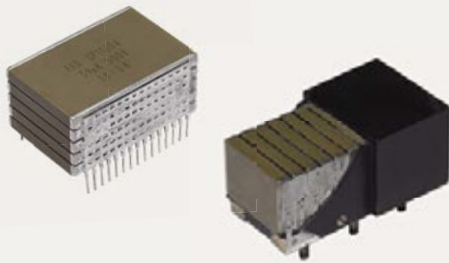

HIGH VOLTAGE

- Up to 50 kV
- Specific circular shape

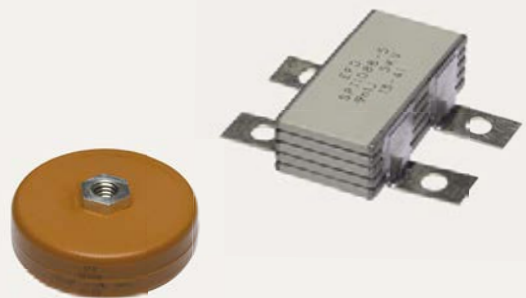

HIGH TEMPERATURE

- Up to 250°C
- Specific shape of connections
- 2,000 hours life time
- HMP soldering

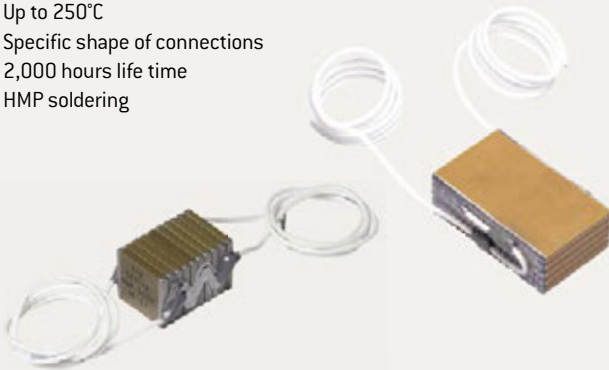

OTHERS

- Screen printed resistors
- Complex components
- Full functions available

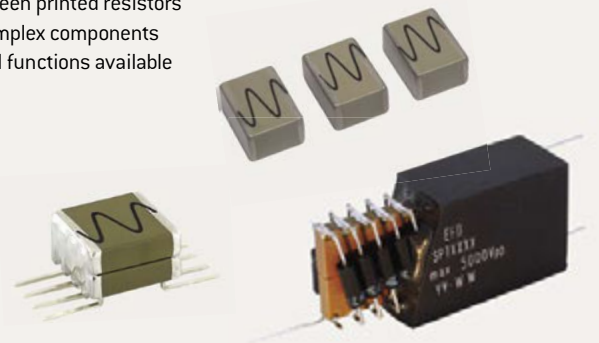

General Information

MATERIALS EXPERT

For 50 years and as a market leader, EXXELIA's comprehensive knowledge of the materials properties and performances have enabled us to design capacitors in Porcelain, NPO, BX, 2C1, BP, X7R and –2200ppm/°C ceramics.

CUSTOM DESIGNS

Our catalog products don't meet your application?

Based on the valuable experience accumulated over the design of 2,000+ specific ceramic capacitors, you can trust EXXELIA to define a qualitative custom solution in a time effective manner.

NO OBSOLESCENCE

Choosing a standard or custom EXXELIA product means you won't have to worry about obsolescence.

TYPICAL APPLICATIONS

- Aerospace & Defense: cockpit panels, flight control, radio systems, missile guidance systems...
- Space: military and commercial satellites, launcher...
- Medical: MRI, external defibrillators, implantable devices...
- Telecommunications: base stations...
- Oil and gas: drilling tools, MWD, LWD, wellheads...

ISO 9001 AND AS9100C

Quality is at the core of Exxelia's corporate culture. Each sites has its own certifications.

CERTIFICATIONS

Capacitors manufactured by EXXELIA comply with American and European standards and meet the requirements of many international standards.

For Space qualified parts (ESA QPL), please refer to our catalog «Ceramic capacitors for Space applications».

QUALITY & RELIABILITY

EXXELIA is committed to design and manufacture high quality and reliability products. The test cycles reproducing the most adverse operating conditions over extended periods (up to 10 000 hours) have logged to date well over 5.10⁹ hours/Component.

Failure rate data can be provided upon request.

CONFLICT MINERALS

EXXELIA is committed to an approach based on «Conflict Minerals Compliance». This US SEC rule demands complete traceability and a control mechanism for the mineral procurement chain, encouraging importers to buy only «certified» ore.

We have discontinued relations with suppliers that procure from the Democratic Republic of the Congo or an adjoining country.

ENVIRONMENT

EXXELIA is committed to applying a robust environmental policy, from product design through to shipment. To control its environmental footprint and reconcile this with the company' functional imperatives, our environmental policy provides for the reduction or elimination of hazardous substances. We also focus on compliance with European Union directives and regulations, notably REACH and RoHS.

RoHS COMPLIANCY

SMD CAPACITORS

The capacitor terminations are generally protected by a nickel barrier formed by electrolytic deposit. This barrier gives chip capacitors leaching performance far exceeding the requirements of all applicable standards. The nickel barrier guarantees a minimum resistance to soldering heat for a period of 1 minute at 260°C in a tin-lead (60/40) or tin-lead-silver (62/36/2) bath without noticeable alteration to the solderability. It also allows repeated soldering-unsoldering and the longer soldering times required by reflow techniques.

However nickel barrier amplifies thermal shock and is not recommended for chip sizes equal or greater than CNC Y (30 30) - (C 282 to C 288 - CNC 80 to CNC 94).

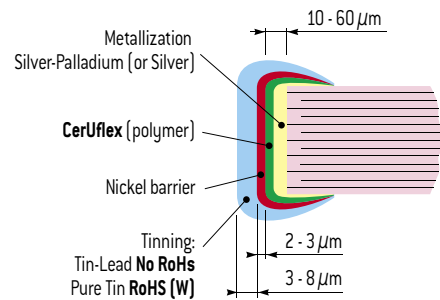

LEADED COMPONENTS

As well as for SMD products, leaded capacitors ranges can also be RoHS. These products, which are characterized by the suffix «W» added to the commercial type, are naturally compatible with the soldering alloys used in RoHS mounting technology. The connections coating is generally an alloy SnAg (with a maximum of 4% Ag). However, on a few products that EXXELIA will precise on request, the coating is pure silver.