

## FP-9-300

### Highlights

- Conduction cooled
- Polypropylene dielectric
- Self-healing
- Operating frequency up to 700 KHz
- Maximum operating core temperature 85°C
- Capacitance tolerance  $\pm 10\%$
- Flame retardant UL94 - V0, ROHS compliant

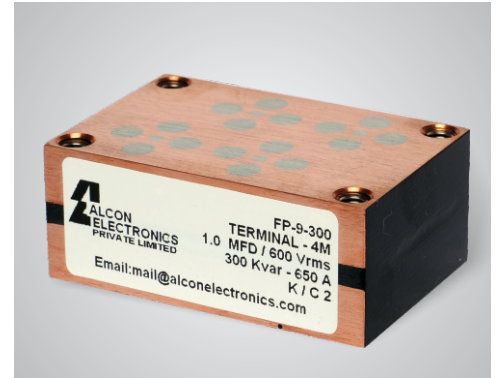

### Standard Capacitor Values

| Rated Voltage Vrms | Nominal Capacitance MFD at 1KHz | Max Current Irms | Max Power Kvar | Frequency KHz | ESR mΩ | Dimensions mm |    |    | Case Code | Terminal Style | Ordering Code           |
|--------------------|---------------------------------|------------------|----------------|---------------|--------|---------------|----|----|-----------|----------------|-------------------------|
|                    |                                 |                  |                |               |        | B             | H  | L  |           |                |                         |
| 1000               | 0.10                            | 350              | 300            | 476-649       | 1.2    | 30.2          | 50 | 75 | F1        | 4M             | SP00U101000A10F1004MK01 |
|                    | 0.20                            | 400              | 300            | 238-423       | 1.2    | 30.2          | 50 | 75 | F1        | 4M             | SP00U201000A10F1004MK01 |
| 700                | 0.33                            | 500              | 300            | 295-401       | 1.0    | 30.2          | 50 | 75 | F1        | 4M             | SP00U330700A10F1004MK01 |
|                    | 0.66                            | 500              | 300            | 147-200       | 0.8    | 30.2          | 50 | 75 | F1        | 4M             | SP00U660700A10F1004MK01 |
| 600                | 1.00                            | 650              | 300            | 132-223       | 0.5    | 30.2          | 50 | 75 | F1        | 4M             | SP000010600A10F1004MK01 |
|                    | 1.32                            | 650              | 300            | 100-170       | 0.3    | 30.2          | 50 | 75 | F1        | 4M             | SP01U320600A10F1004MK01 |
| 500                | 2.60                            | 650              | 300            | 72-85         | 0.2    | 30.2          | 50 | 75 | F1        | 4M             | SP02U600500A10F1004MK01 |
| 400                | 5.00                            | 800              | 300            | 59-67         | 0.1    | 30.2          | 50 | 75 | F1        | 4M             | SP000050400A10F1004MK01 |

### Capacitor Drawing and Terminal Style

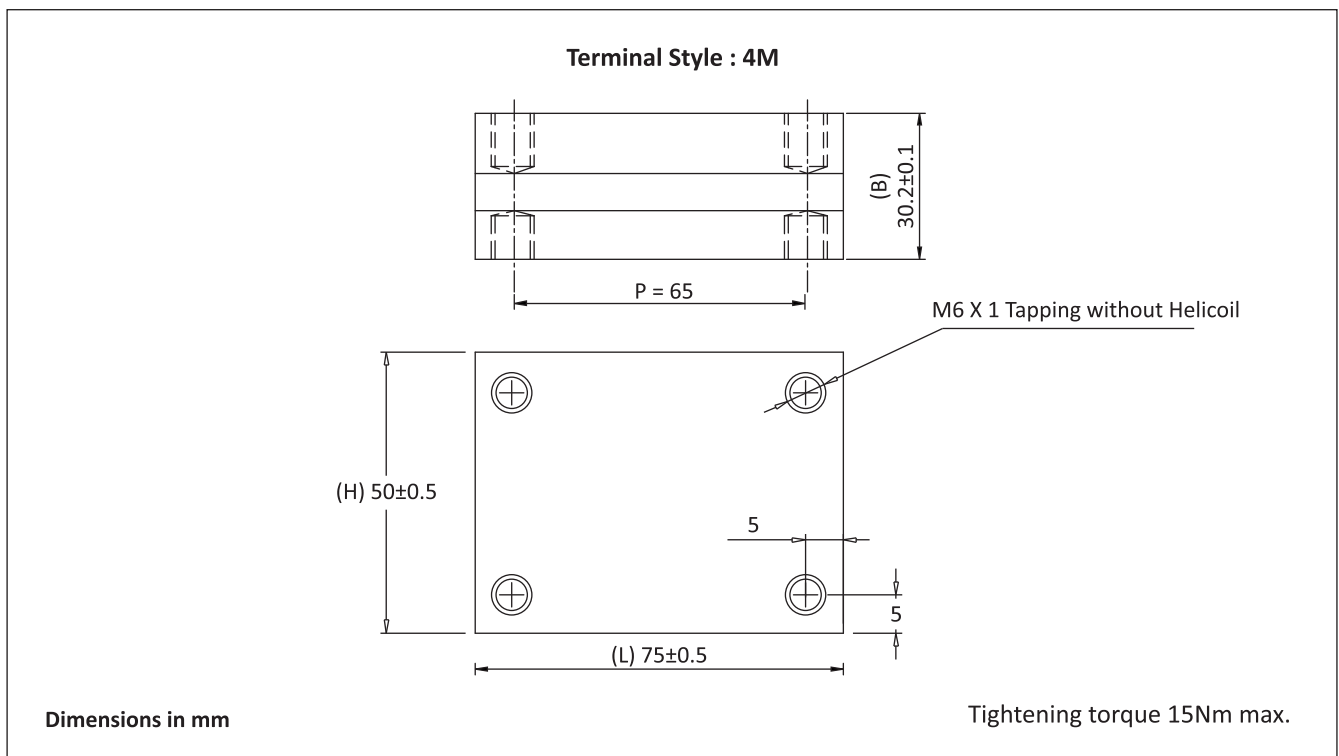

## FP-9-300

### Frequency Derating

—◆— Voltage    —■— Current    —▲— Power

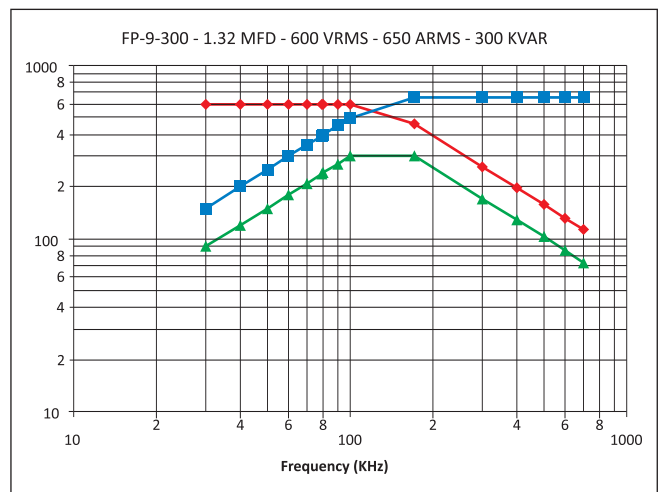
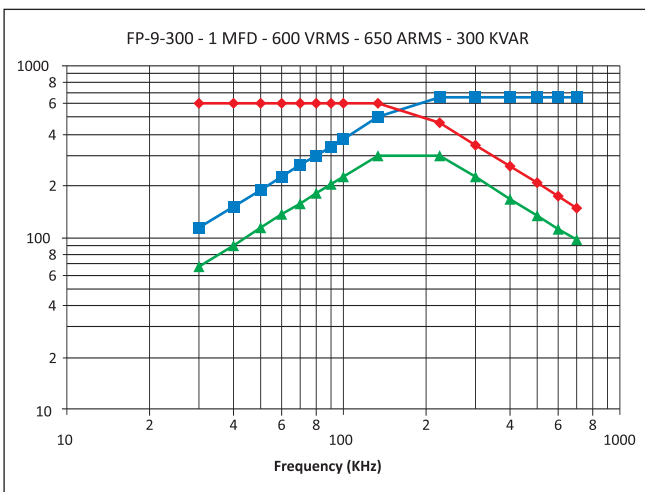
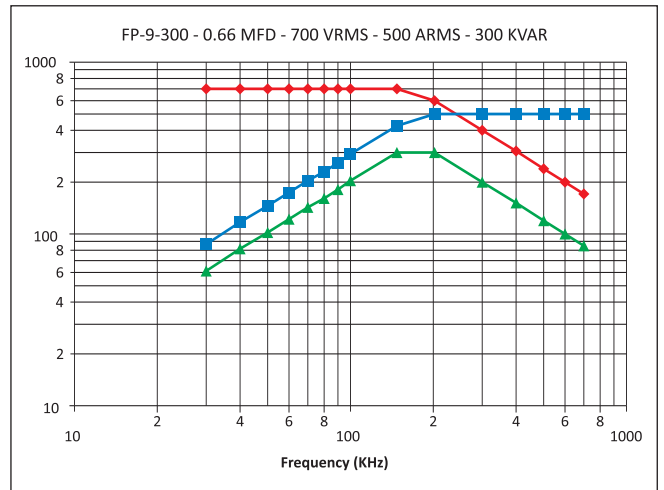
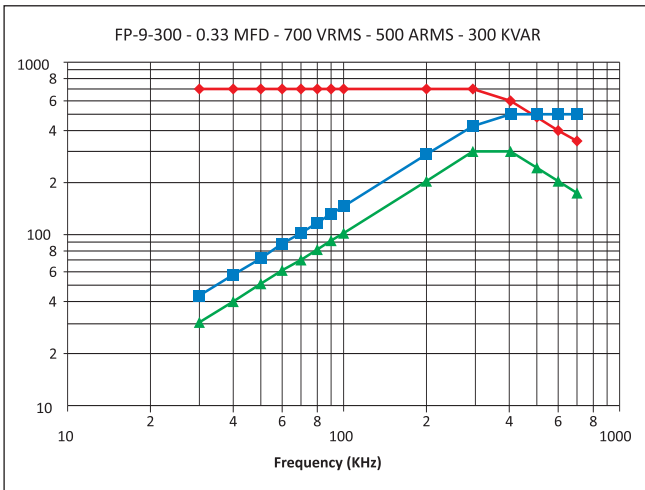
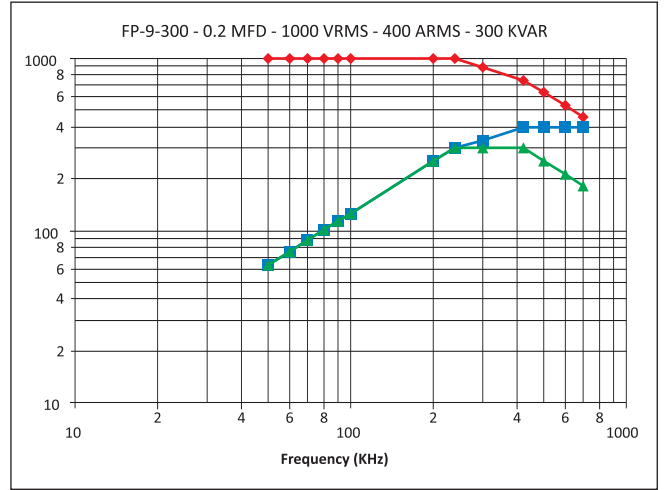
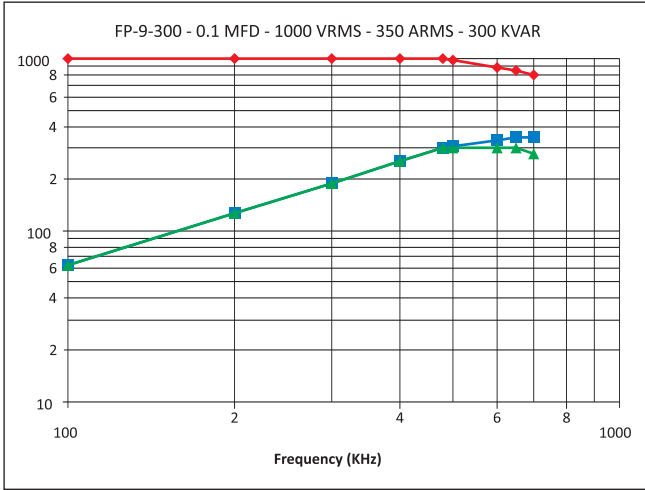

## FP-9-300

### Frequency Derating

—●— Voltage    —■— Current    —▲— Power

