

FP-34-300

Highlights

- Conduction cooled
- Polypropylene dielectric
- Self-healing
- Operating frequency up to 700 KHz
- Maximum operating core temperature 85°C
- Capacitance tolerance $\pm 10\%$
- Flame retardant UL94 - V0, ROHS compliant



Standard Capacitor Values

| Rated Voltage Vrms | Nominal Capacitance MFD at 1KHz | Max Current Irms | Max Power Kvar | Frequency KHz | ESR mΩ | Dimensions mm | | | Case Code | Terminal Style | Ordering Code |
|--------------------|---------------------------------|------------------|----------------|---------------|--------|---------------|----|----|-----------|----------------|-------------------------|
| | | | | | | B | H | L | | | |
| 1000 | 0.10 | 350 | 300 | 476-649 | 1.2 | 34 | 50 | 50 | Q1 | 5H | SP00U101000A20Q1005HK01 |
| | 0.20 | 400 | 300 | 238-423 | 1.2 | 34 | 50 | 50 | Q1 | 5H | SP00U201000A20Q1005HK01 |
| 700 | 0.25 | 500 | 300 | 390-530 | 1.2 | 34 | 50 | 50 | Q1 | 5H | SP00U250700A20Q1005HK01 |
| | 0.33 | 500 | 300 | 295-401 | 1.0 | 34 | 50 | 50 | Q1 | 5H | SP00U330700A20Q1005HK01 |
| | 0.66 | 500 | 300 | 147-200 | 0.8 | 34 | 50 | 50 | Q1 | 5H | SP00U660700A20Q1005HK01 |
| 600 | 1.00 | 650 | 300 | 132-223 | 0.5 | 34 | 50 | 50 | Q1 | 5H | SP000010600A20Q1005HK01 |
| | 1.20 | 650 | 300 | 111-187 | 0.5 | 34 | 50 | 50 | Q1 | 5H | SP01U200600A20Q1005HK01 |
| | 1.32 | 650 | 300 | 100-170 | 0.3 | 34 | 50 | 50 | Q1 | 5H | SP01U320600A20Q1005HK01 |
| 500 | 2.40 | 650 | 300 | 80-97 | 0.2 | 34 | 50 | 50 | Q1 | 5H | SP02U400500A20Q1005HK01 |

Capacitor Drawing and Terminal Style

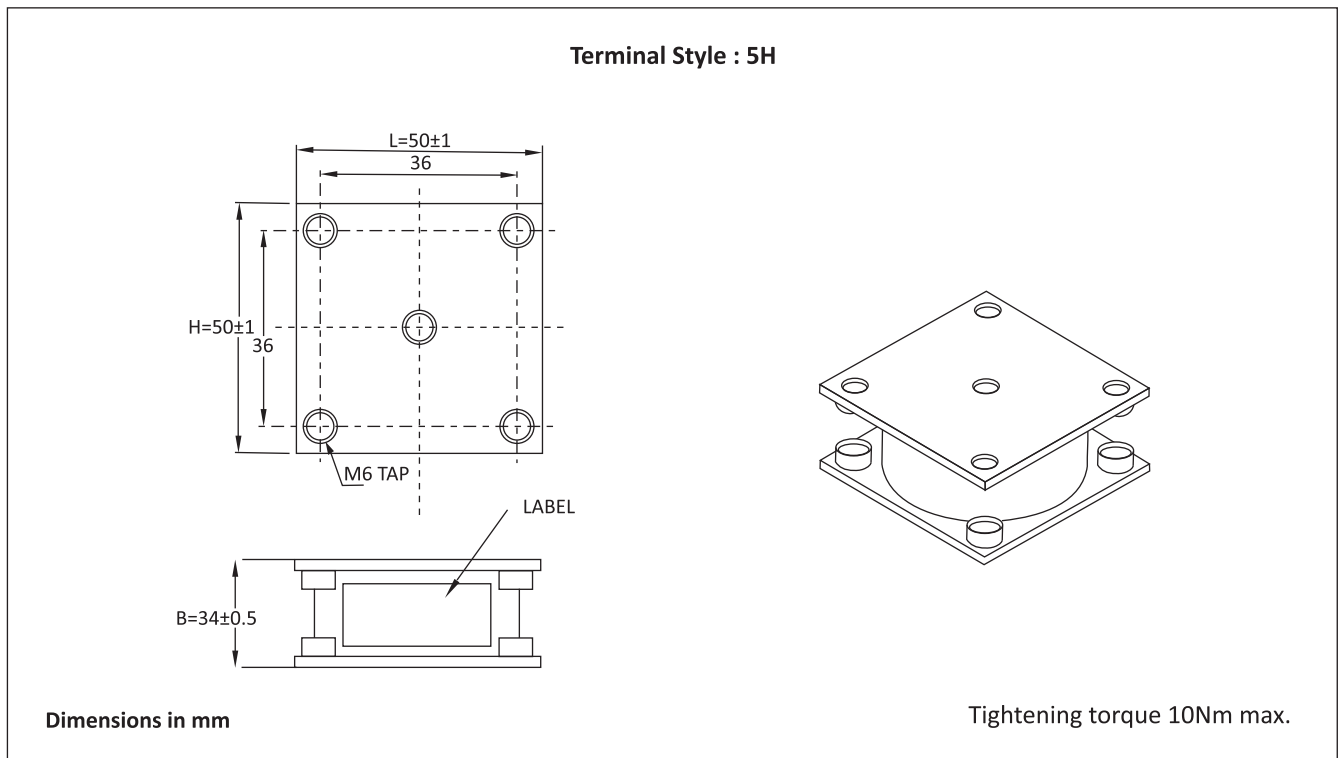

FP-34-300

Frequency Derating

—●— Voltage —■— Current —▲— Power

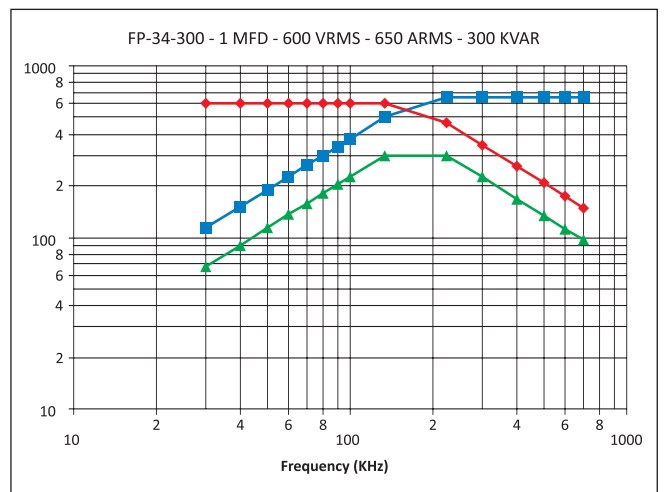
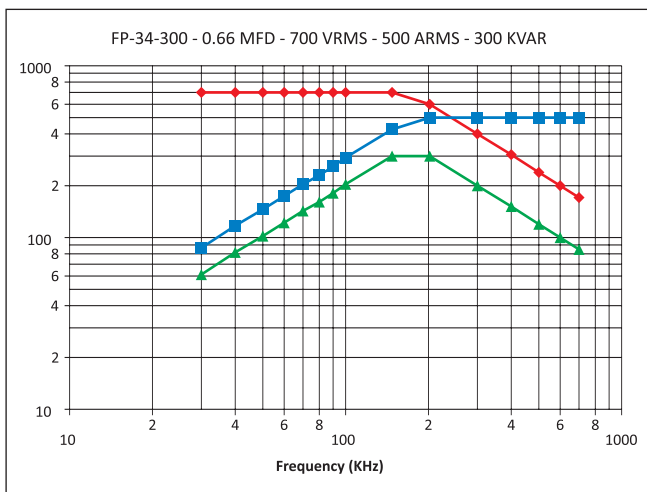
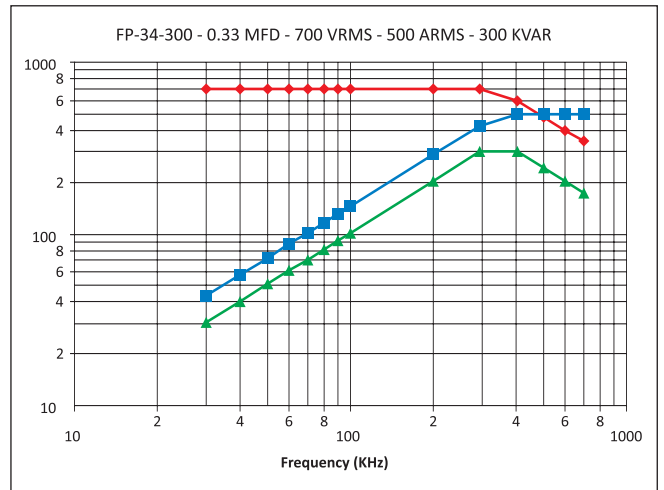
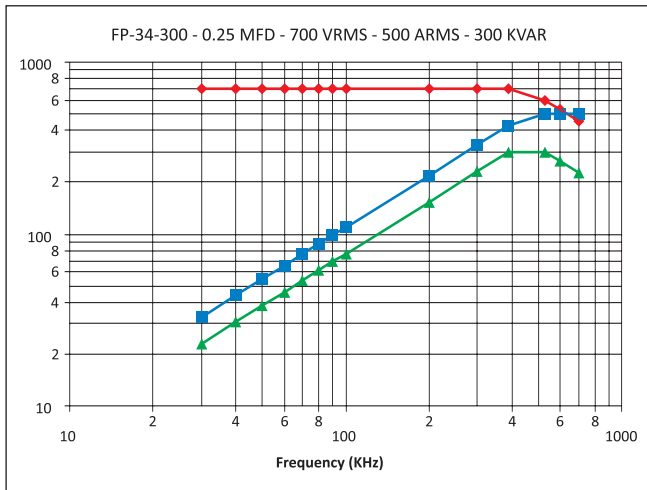
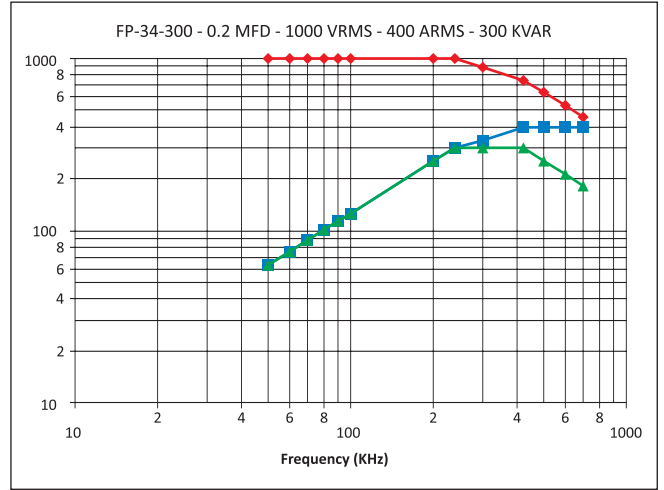
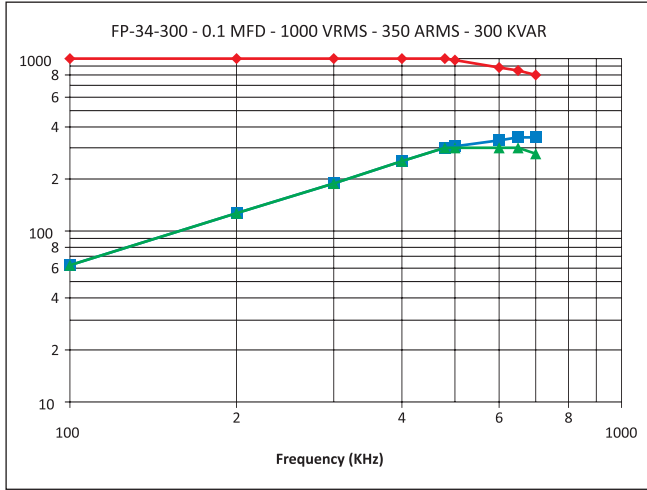

FP-34-300

Frequency Derating

—◆— Voltage —■— Current —▲— Power

