

SMD Power Inductors CCM 6 1W High Reliability Applications

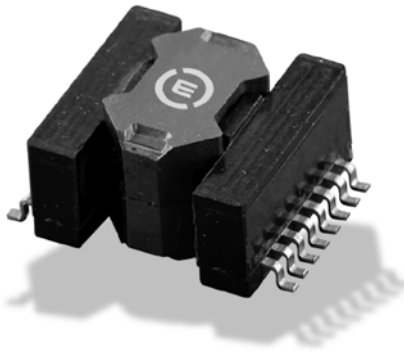

- Energy storage, smoothing, filtering
- Applied standards: ECSS-Q-70-02, MIL-STD-202, D0-160
- Compliant with EESA ESCC 3201/011
- Materials meet UL94-V0 rating
- Suited for I_R and vapor reflow soldering
- Frequency range up to 1 MHz
- Operating temperature range: -55°C to +125°C
- Weight: 12 grams

Electrical Data (25°C)

ID Code	L ¹ no load ±5% (μH)	I ² rated max (A)	I ³ peak max (A)	L ⁴ at I peak ±10% (μH)	R _{dc} ±10% (mΩ)
CCM 6 2K2 1W	2,18	10,9	13,6	2,07	2,98
CCM 6 3K4 1W	3,40	8,9	11,1	3,23	4,27
CCM 6 4K7 1W	4,70	7,7	9,63	4,47	4,27
CCM 6 6K7 1W	6,66	6,9	8,63	6,33	6,36
CCM 6 10K 1W	10,2	5,4	6,75	9,73	9,62
CCM 6 15K 1W	15,2	4,3	5,38	14,4	16
CCM 6 22K 1W	21,9	3,7	4,63	20,8	21
CCM 6 33K 1W	32,9	3	3,75	31,3	27
CCM 6 47K 1W	46,2	2,6	3,25	43,9	38
CCM 6 68K 1W	67,0	2,1	2,63	63,7	63
CCM 6 M10 1W	100	1,72	2,15	95,0	97
CCM 6 M15 1W	154	1,42	1,78	146	137
CCM 6 M22 1W	219	1,21	1,51	208	181
CCM 6 M33 1W	324	0,96	1,20	308	307
CCM 6 M47 1W	467	0,83	1,04	443	379
CCM 6 M68 1W	676	0,68	0,850	642	564
CCM 6 M100 1W	999	0,56	0,700	949	827
CCM 6 M150 1W	1505	0,45	0,563	1430	1401
CCM 6 M200 1W	2190	0,38	0,475	2081	1759

Notes

1. Inductance at 0.25 V, 100 kHz
2. I rated (permanent DC) without heatsink
3. I peak = I rated + I ripple = 150% I rated
I ripple = 50% I rated at F=500 kHz
4. I peak defined at T env = +85°C and T internal max < +125°C

Iron losses calculated with converter duty cycle α = 0.25
Dielectric withstanding 500 Vrms (winding/magnetic core)
Isolation resistance > 1 GΩ (winding/magnetic core)

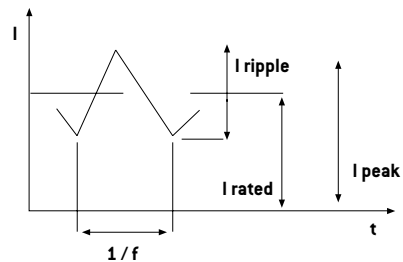

To Order

CCM 6 ### #W

CCM	6	###	#	W
SMD Energy Storage Inductor	Size	Value code 4K9 = 4,9 μH M10 = 100 μH 1M0 = 1000 μH	Version	GW Terminals

Dimensions (mm, top view)

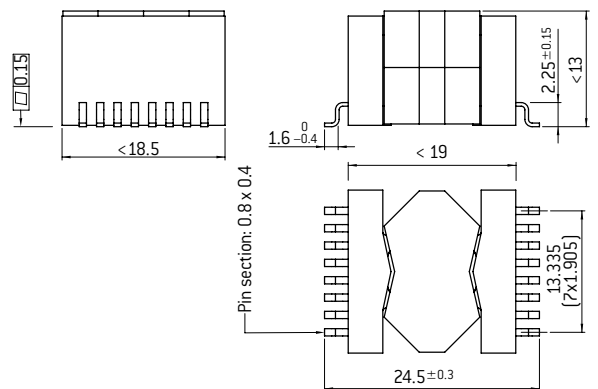

PCB Layout (suggested)

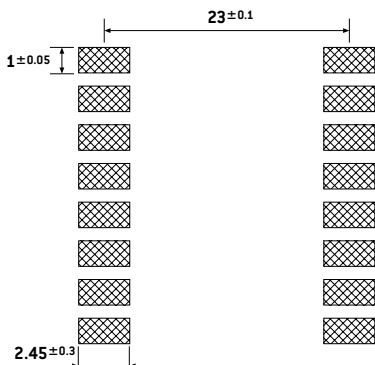

Connections

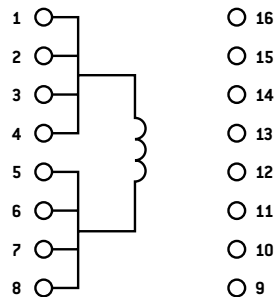

CCM Technology

• esa ESCC Technology Flow Certificate for Custom CCM Components ESCC 3201011



Features

- Designed to withstand severe environment as space, avionics, New Space applications
- Bobbin winding Technology using standard profiles (RM, EQ,..)
- Epoxy Transfer molding technology
- SMD package
- Multiple pins with multi-wire connections possibilities
- Ferrite core External assembly
- Optimized heat transfer to pins and PCB

- Applied standards: MIL-STD202, ECSS-Q-70, D0-160D,
- Pick and place compatible
- Materials meet UL94-V0 rating
- Temperature range: -55°C +125°C
- RoHS by default, non RoHS upon request
- Meets solderability tests per MIL-STD 202-Method 208
- Optional tape and reel packaging
- • esa qualified technology ESCC 3201/011

Benefits

- Withstand high shocks and vibration (MIL STD 202 Method 213 & 204)
- Good repeatability of electrical characteristics, allow good regulation of multiple outputs power supply
- Higher power density up to +20% compared to standard package
- Easy to pick and place (tape and reel or tray)
- Flexibility of use
- No stress on the Ferrite
- New Space applications compatible

Indicative Electrical Data

Platform	Inductor Range (I _{DC} +20% ripple)	Transformer for SMPS *	Indicative Weight (grammes)
CCM4	18mH/50mA → 3μH/6A	Up to 18W	5.1
CCM5	29mH/80mA → 4.2μH/8A	Up to 30W	7.4
CCM6	120mH/30mA → 3μH/10A	Up to 40W	12.1
CCM20	240mH/30mA → 2.6μH/21A	Up to 120W	21.4
CCM25	480mH/40mA → 4μH/25A	Up to 200W	44.2

* Based on a push pull architecture, at f = 200 kHz @85°C without cooling

Overview of custom Electrical functions in this technology

- Common mode chokes
- PFC chokes
- Gate Drive transformers
- SMD filtering chokes
- Current transformers
- Flyback transformers
- Forward transformers
- Push-Pull transformers
- ...

Temperature elevation (Δt) compare between Industrial and High Grade technologies

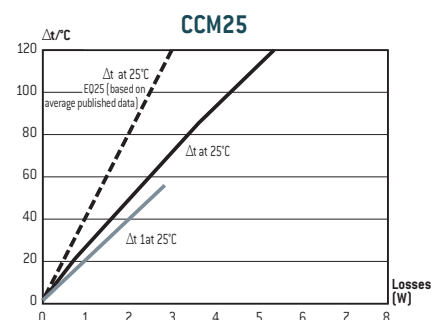
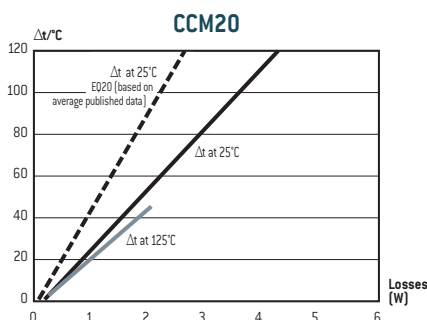
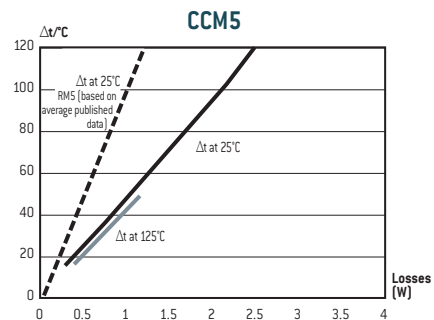
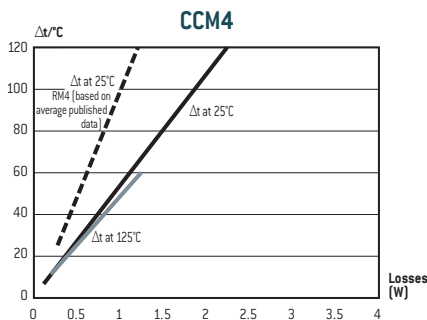

CCM Technology

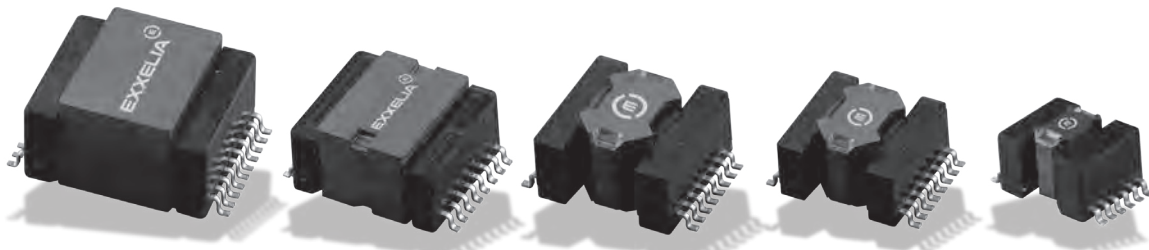

CCM 25

CCM 20

CCM 6

CCM 5

CCM 4

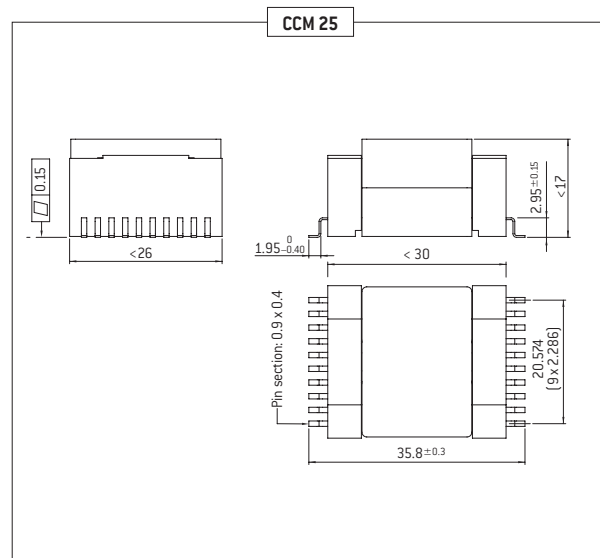
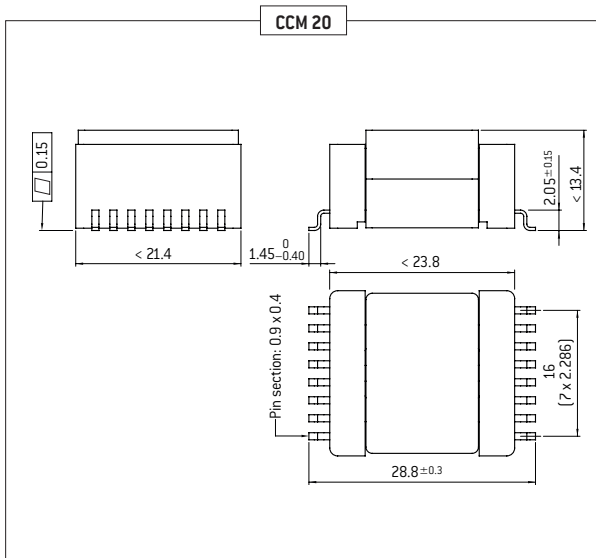
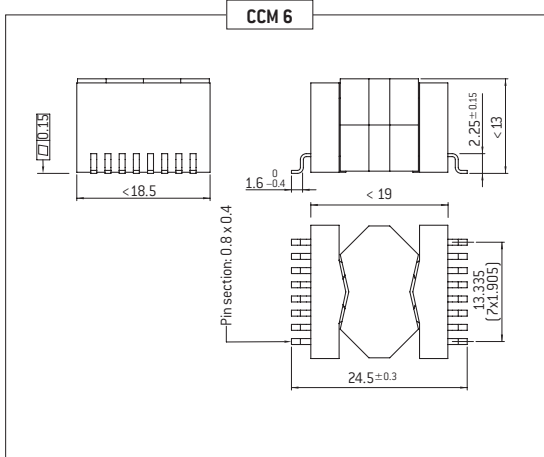
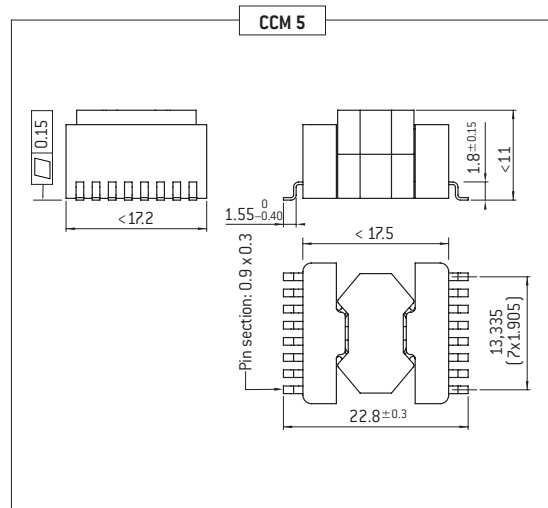
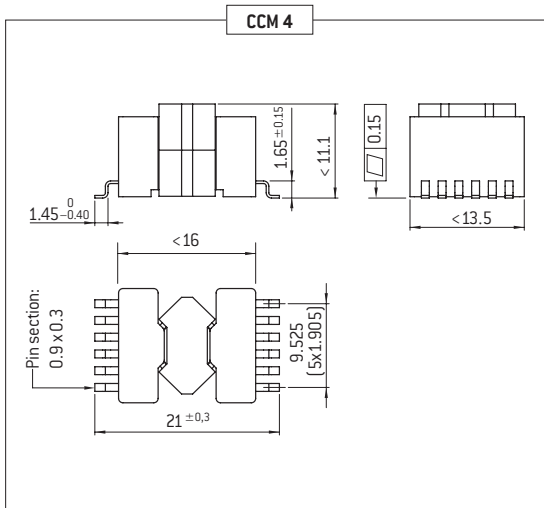

HIGH GRADE TECHNOLOGY

Engineering Support

DESIGN CAPABILITIES

Exxelia designs magnetics for most applications:

- Switch-mode power supply including new and unusual architectures
- 360-800Hz Power supply (single and multipulse)
- 50 Hz power supply
- Current and Voltage measurement
- Lighting - Ignition
- Pulse transformer (gate drive, data)
- Micro inductor
- Audio-frequency
- Electromagnets etc.

Exxelia designs magnetics up to:

- 200kV dielectric strength
- 20kV operating voltage ...
- 240°C operating temperature

According to the main aerospace standards

- ESA ESCC 3201
- MIL-STD-981
- MIL-PRF-27
- DO-160 etc

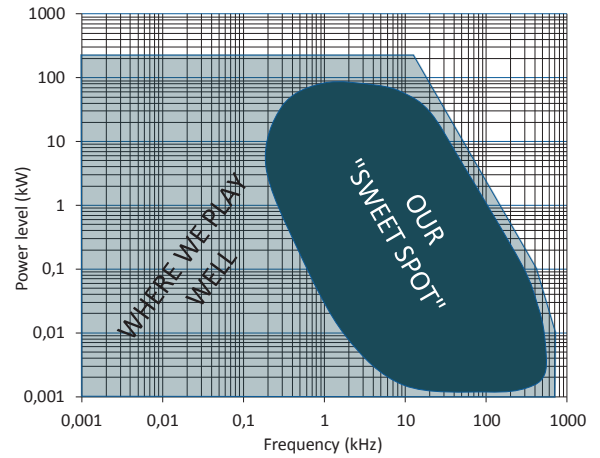

SWITCHED MODE POWE SUPPLY

Cross regulation in multi output Flyback converters

Exxelia has been working on this subject in order to understand the phenomenon, identify the cause(s) and find solutions to avoid the use of linear regulators consuming energy

The identification of a relevant magnetostatic model of the transformer and its electronic environment are necessary for analysis of the phenomenon into circuit simulation software like PSIM or PSPICE. This allows to evaluate the influence of the model parameters and the other components of the converter on the variability of output voltages.

The key point is then to link the product manufacturing technology to the parameters of the model, in order to reduce cross regulation thanks to the optimization of windings arrangement.

The work on this topic allows a precise control of the output voltages on the most sensitive windings.

Dual Active Bridge, small size & high efficiency

The dual active bridge is a topology more and more used to supply batteries because it allows bidirectional energy transfer with the network.

Exxelia is developing high reproducibility technology to integrate inductors in the transformer:

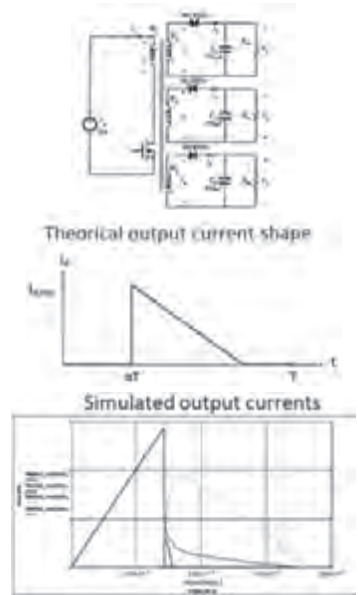

Example

3 Transformers in each power supply

Each transformer incorporates virtual inductance Lk

15 kW combined output @ 100 kHz switching

Taps provide flexibility for 350 V / 700 V input & 28 V or 56 V output (up to 430 A)

Exxelia value proposition: Small size, high efficiency, competitive cost despite multiple high current outputs and integrated inductors.

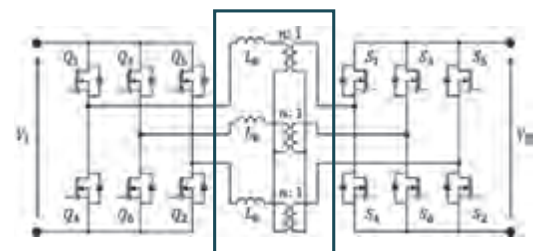

360-800Hz MULTI PULSE

Exxelia developed a specific knowledge to optimize the design of single and multi-pulse magnetics for 360 – 800 Hz power network.

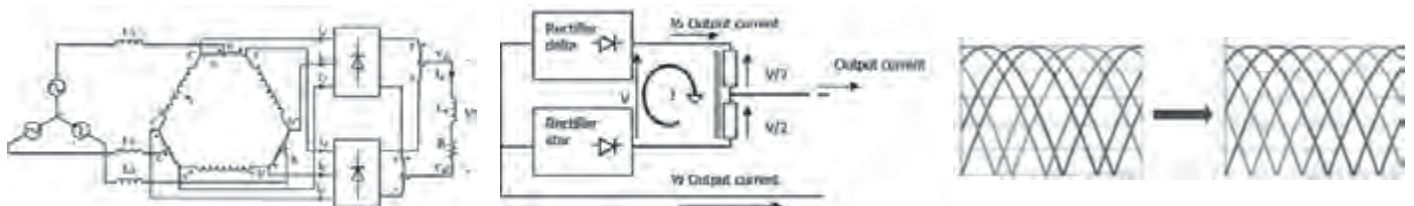

Global Optimization of the magnetics in the power supply Transformer/Autotransformer and Interphase Inductor

Consideration of limit operation conditions

Harmonic reduction thanks to losses management

ACCURATE MEASUREMENT TRANSFORMERS (0.1%) FOR CRITICAL APPLICATIONS

Real-time, detailed knowledge of the voltages and currents is becoming increasingly important to ensure the proper operation of electrical networks. This is as true for the aeronautics market as it is for the industrial market.

Measurement transformers, whether current or voltage, are sensors. They must faithfully transmit a signal level in a highly variable environment (excitation, frequency, temperature) which influences their characteristics.

Exxelia developed a designing method that takes into account all environmental conditions. The behavior of the sensor is modeled by a transfer function that depends on transformer characteristics and on the load resistance.

Depending on the application and the targeted accuracy, Exxelia defines the best operating point of the sensor by calculating the worst case errors with respect to the variability of the model parameters.

Exxelia designs sensors with an accuracy of up to 0.1%.

THERMAL MANAGEMENT, A PATH TO MINIATURIZATION

For Exxelia, better thermal management translates into miniaturization of the component.

Indeed, thanks to an accurate calculation of the maximum operating temperature, Exxelia can design the smallest component able to transfer a given power.

The calculation of this temperature requires the knowledge of the heating sources (core and copper losses) and the component thermal behavior.

Exxelia uses a calculation method to do the best use of core losses data and improve them by developing partnership with core manufacturer

The copper losses due to Eddy current are taken into account by Exxelia through the identification of the overriding causes and the use of the most relevant analytical approaches to evaluate them.

The calculation of the operating temperature from the losses requires to determine the thermal resistance, which varies according to the ambient temperature, the power dissipated and the exchange conditions with the environment.

Exxelia performs measurement campaigns to determine the thermal resistances and their variation for its qualified technologies and for most of the standard ferrite shapes. In particular, the influence of natural convection is taken into account to address products for Space.

When more detailed analysis is required, Exxelia has developed a unique thermal simulation software, based on finite element calculation and dedicated to magnetic components to make its use easier and faster.

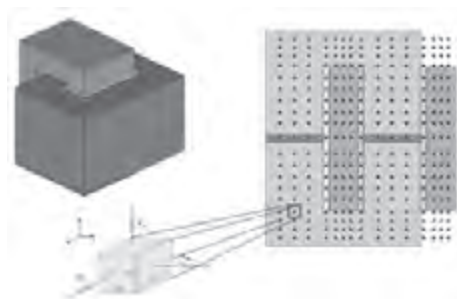

Finite element analysis

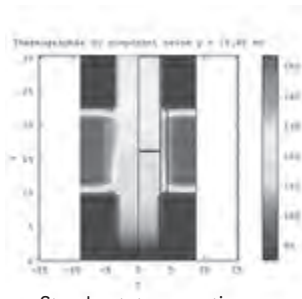

Steady state operating temperature calculation

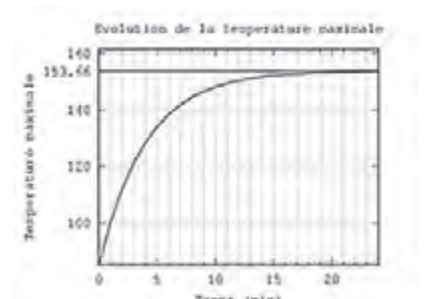

Transient

HIGH VOLTAGE AND ELECTRIC FIELD CALCULATION

Exxelia developed specific design skills to anticipate voltage increase requested for aircraft and space embedded application. High voltage topic is mastered with both dedicated test equipment (up to 100kV) and electric field calculation knowhow.

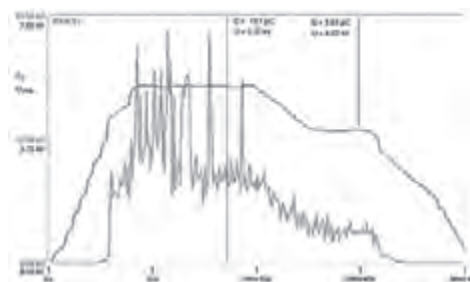

Partial discharge equipment available up to 100kV

Engineering Support

Electric Field mitigation: In high voltage applications, local high electric field E [kV/mm] can lead to a premature aging of insulating parts or insulators? (Partial discharge) and finally to an electric failure.

Simulation in the design phase, using finite element calculations with a 2D or 3D electrostatic software allows Exxelia to reduce high field areas and increase lifetime.

Example: Electric Field, Iso-Voltage values



Custom High Voltage Transformer

ELECTROMECHANICAL DEVICES

Exxelia engineers use advanced finite-elements simulation software to model and analyse electromagnetic behaviour.

EXXELIA can provide a high added-value support for electromechanical devices optimization through electromagnetic and thermal calculations (weight reduction, torque increase, losses reduction, etc...):

- 2D and 3D calculations:
 - Magnetostatic: B [T], J [A/mm²], L matrix (function of current)
 - Electrostatic: E [kV/mm], C matrix
 - Eddy current (AC) in magneto-harmonic
 - 2D transient coupled multiphysics (electric + magnetic + circuit)
- Specific analysis:
 - Optimization under constraints
 - Parametric analysis
 - Sensitivity analysis



CAD geometry and circuit import/export (step, Catia, Spice, ...)

Some calculations: Torque [N.m], Force [N], Resistance [Ω], Losses [W], L matrix [H], C matrix [F]

Some applications: linear or angular electric motor, electromagnet, linear or angular actuator, proportional valves, position sensor, etc... Proportional Hydraulic Valve

Topology analysis: Based on an extensive experience, Exxelia can offer the best topology dedicated to an application or look for the best performance within a given space:

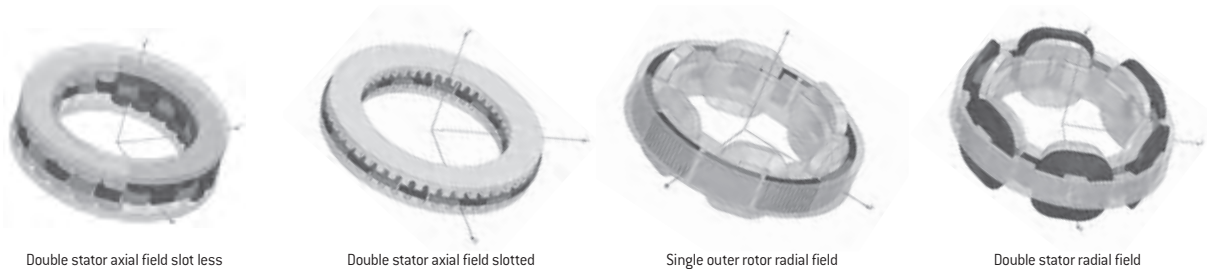

Torque, field and geometrical optimization

