

High Capacitance Stacked Capacitors

SC / SV Series

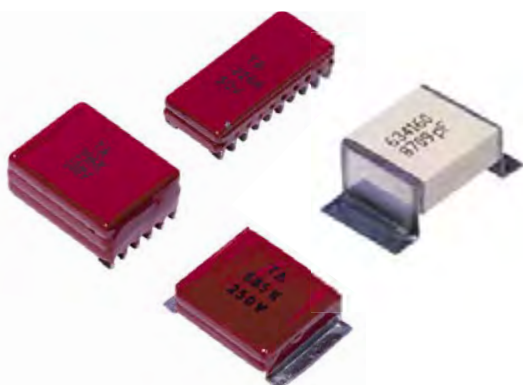

FEATURES

- Multilayer stacked ceramic capacitors
- Dielectric type II
- Capacitance range: 47nf to 390 μF
- Voltage range: 50 V_{DC} to 500 V_{DC}
- SV Series: 2 wires components
- SC Series: 4 wires (W4), Dual In Line (DIL) or ribbons terminations

MARKING

Size	Marking codes	Example
All sizes	«TA» logo	TA
	Cap code + Tolerance code	105M
	Rated voltage value	100 V

PACKAGING

«Blister» boxes:

For all products, special «blister» boxes are used to optimize the protection of the parts during the carriage and the storage. Depending upon the termination (with or without connection) and the size, the number of the parts in each box is defined. Please, consult us for more details.

ELECTRICAL SPECIFICATIONS

Description	«X» Series (type II)	«T» Series (type II)
CECC	2R1	2R1
EIA	X7R	X7R
Exxelia Temex Code	X	T
Operating temperature range	-55°C to +125°C	-55°C to +125°C
Maximum ΔC/°C over Temperature range without voltage applied	± 15%	± 15%
Ageing	≤2.5% per decade hour	≤2.5% per decade hour
Dissipation Factor (DF)	≤ 2.5%	≤ 2.5%
Voltage proof	U _R ≤ 200 V: 2.5 x U _R U _R > 200 V: 2.0 x U _R	U _R ≤ 200 V: 2.5 x U _R U _R > 200 V: 2.0 x U _R
Insulation Resistance (IR) at 25°C under U _R	100GΩ or 1000Ω.F whichever is the less	100GΩ or 1000Ω.F whichever is the less
Insulation Resistance (IR) at 125°C under U _R	10GΩ or 100Ω.F whichever is the less	10GΩ or 100Ω.F whichever is the less
Measurement Conditions for C and DF at 20°C	≤ 100pF: 1MHz / 1Vrms (no bias) > 100pF: 1KHz / 1Vrms (no bias)	≤ 100pF: 1MHz / 1Vrms (no bias) > 100pF: 1KHz / 1Vrms (no bias)
Capacitance versus applied Voltage and Temperature	See page 68	See page 68

HIGH CAPACITANCE

HOW TO ORDER

201	SV	01	X	105	K	R	-	-RoHS																		
Rated voltage	Series	Exxelia size code	Dielectric code	Capacitance	Tolerance	Termination	Coating	RoHS Compliant																		
500: 50 V 104: 100 V 201: 200 V 501: 500 V	SC SV	00 (SC only) 01 02 03 04 05 06 07 10 (SC only) 11 (SC only) 12 (SC only) 18 (SC only)	X = X7R T = X7R	1 st two digits represent significant figures; last digit specifies the number of zeros to follow. Examples: 104: 0.1μF 335: 3.3μF 156: 15μF 107: 10μF	K = ±10% M = ±20%	<table border="1"> <thead> <tr> <th colspan="2">SC Series</th> </tr> </thead> <tbody> <tr> <td>DN DIL N type</td> <td>RoHS = 100% tinned phosphor bronze, non magnetic. Lead status: 0% Pb.</td> </tr> <tr> <td>DJ DIL J type</td> <td>Non RoHS = Sn (60%) Pb (40%) plated phosphor bronze, non magnetic. Lead status: Pb 40% of the plated layer.</td> </tr> <tr> <td>DL DIL L type</td> <td></td> </tr> <tr> <td>RL Ribbon L type</td> <td>RoHS = 100% tinned copper, non magnetic. Lead status: 0% Pb</td> </tr> <tr> <td>RJ Ribbon J type</td> <td>RoHS = 100% tinned copper, non magnetic. Lead status: 0% Pb.</td> </tr> <tr> <td>W4 Radial 4 wires</td> <td>Non RoHS = Sn (70%) Pb (30%) plated Copper, non magnetic. Lead status: Pb 30% of the plated layer.</td> </tr> <tr> <th colspan="2">SV Series</th> </tr> <tr> <td>W2 Radial 2 wires</td> <td>See W4</td> </tr> </tbody> </table>	SC Series		DN DIL N type	RoHS = 100% tinned phosphor bronze, non magnetic. Lead status: 0% Pb.	DJ DIL J type	Non RoHS = Sn (60%) Pb (40%) plated phosphor bronze, non magnetic. Lead status: Pb 40% of the plated layer.	DL DIL L type		RL Ribbon L type	RoHS = 100% tinned copper, non magnetic. Lead status: 0% Pb	RJ Ribbon J type	RoHS = 100% tinned copper, non magnetic. Lead status: 0% Pb.	W4 Radial 4 wires	Non RoHS = Sn (70%) Pb (30%) plated Copper, non magnetic. Lead status: Pb 30% of the plated layer.	SV Series		W2 Radial 2 wires	See W4	- = uncoated and no marking U = uncoated and marked C = coated and marked	- = non-RoHS compliant Both RoHS and non-RoHS versions exist. This is due to the wishes of some customers who still need non-RoHS components in their applications. This suffix must be required for RoHS compliancy.
SC Series																										
DN DIL N type	RoHS = 100% tinned phosphor bronze, non magnetic. Lead status: 0% Pb.																									
DJ DIL J type	Non RoHS = Sn (60%) Pb (40%) plated phosphor bronze, non magnetic. Lead status: Pb 40% of the plated layer.																									
DL DIL L type																										
RL Ribbon L type	RoHS = 100% tinned copper, non magnetic. Lead status: 0% Pb																									
RJ Ribbon J type	RoHS = 100% tinned copper, non magnetic. Lead status: 0% Pb.																									
W4 Radial 4 wires	Non RoHS = Sn (70%) Pb (30%) plated Copper, non magnetic. Lead status: Pb 30% of the plated layer.																									
SV Series																										
W2 Radial 2 wires	See W4																									

SC / SV Series

High Capacitance Stacked Capacitors

DIMENSIONS in inches (mm)

SC SERIES

4 wires W4 terminations

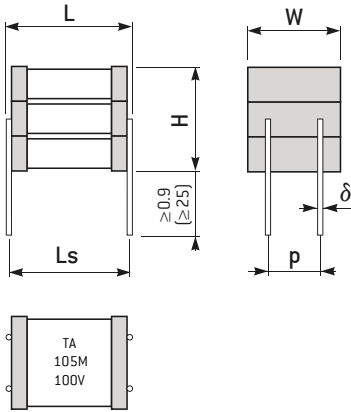

SC SERIES

Dual In Line DIL termination

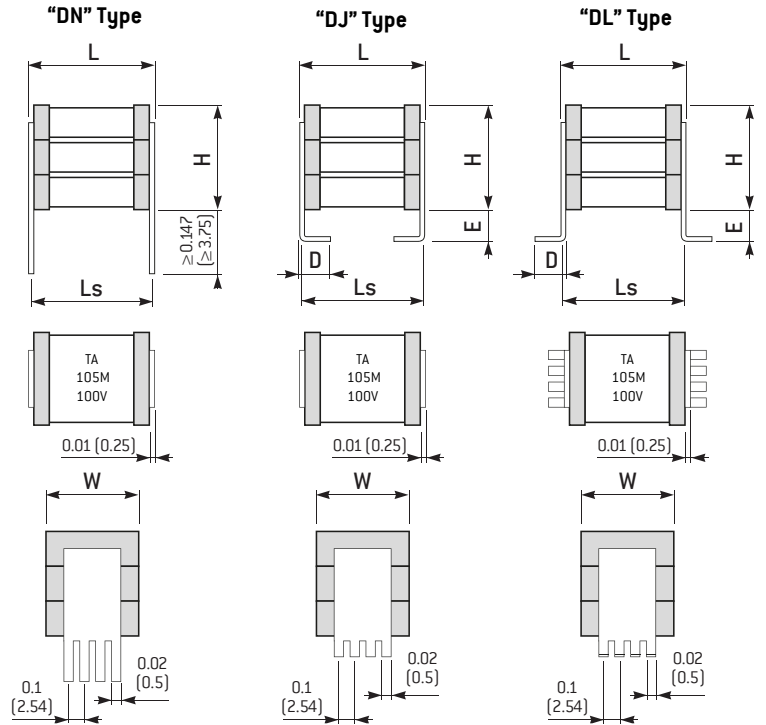

Note: the marking shown here is just given as an example

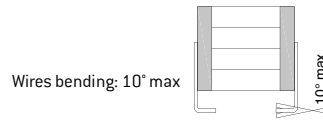

Size	L max.	W max.	Ls ± 0.02 (±0.5)	p ± 0.02 (±0.5)	δ ± 10%	H max.
SC02	0.469 (11.9)	0.449 (11.4)	0.400 (10.16)	0.300 (7.62)	0.024 (0.6)	
SC04	0.650 (16.5)	0.552 (14)	0.600 (15.24)	0.400 (10.16)	0.035 (0.9)	
SC05	0.788 (20)	0.654 (16.6)	0.701 (17.8)	0.400 (10.16)	0.035 (0.9)	
SC06	0.701 (17.8)	0.851 (21.6)	0.600 (15.24)	0.400 (10.16)	0.035 (0.9)	
SC07	0.894 (22.7)	0.654 (16.6)	0.800 (20.32)	0.400 (10.16)	0.035 (0.9)	

Please, consult the tables of standard ratings

Size	L max.	W max.	Ls ± 0.02* (±0.5)*	E ± 0.012 (±0.5)	D ± 0.02 (±0.5)	Number of leads per side	H max.
SC00	0.300 (7.62)	0.276 (7)	0.250 (6.35)	0.071 (1.8)	0.079 (2)	3	
SC01	0.402 (10.2)	0.378 (9.6)	0.300 (7.62)	0.059 (1.5)	0.098 (2.5)	3	
SC02	0.469 (11.9)	0.449 (11.4)	0.400 (10.16)	0.059 (1.5)	0.098 (2.5)	4	
SC04	0.650 (16.5)	0.552 (14)	0.539 (13.7)	0.059 (1.5)	0.098 (2.5)	5	
SC05	0.729 (18.5)	0.670 (17)	0.700 (17.78)	0.059 (1.5)	0.098 (2.5)	6	
SC06	0.701 (17.8)	0.851 (21.6)	0.600 (15.24)	0.059 (1.5)	0.098 (2.5)	7	
SC07	0.894 (22.7)	0.654 (16.6)	0.800 (20.32)	0.059 (1.5)	0.098 (2.5)	6	
SC10	0.520 (13.2)	1.083 (27.5)	0.453 (11.5)	0.083 (2.1)	0.102 (2.6)	10	
SC12	0.945 (24)	1.598 (40.6)	0.800 (20.32)	0.098 (2.5)	0.098 (2.5)	14	

Please, consult the tables of standard ratings

* Except for the SC07, tolerance = ± 0.032 in (±0.8mm).

High Capacitance Stacked Capacitors

SC / SV Series

DIMENSIONS in inches (mm)

SC SERIES

Ribbons R terminations

RJ Type (upon request)

RL Type (standard)

SV SERIES

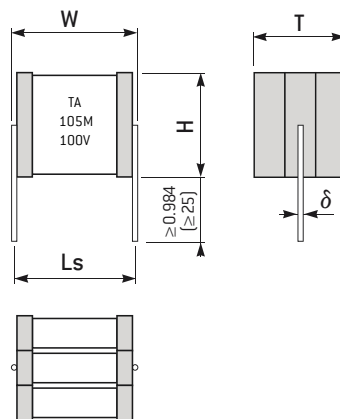
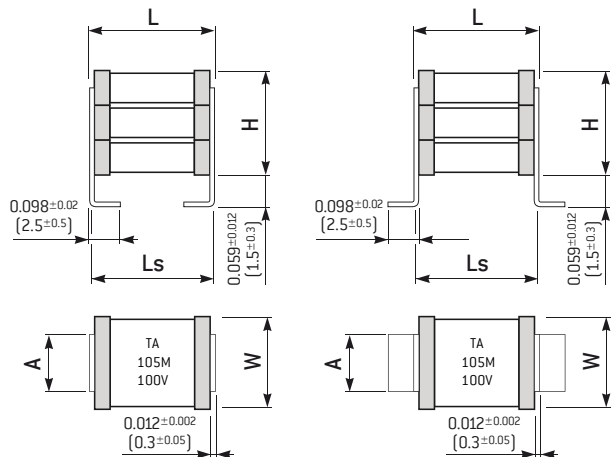

Note: the marking shown here is just given as an example. For the «RJ» version, please consult us.

HIGH CAPACITANCE

Size	L max.	W max.	A ± 0.008 [±0.2]	Ls ± 0.02 [±0.5]	H max.
SC01	0.402 [10.2]	0.378 [9.6]	0.315 [8]	0.415 [10.55]	Please, consult the tables of standard ratings
SC02	0.469 [11.9]	0.449 [11.4]	0.315 [8]	0.482 [12.25]	
SC04	0.650 [16.5]	0.552 [14]	0.315 [8]	0.663 [16.85]	
SC05	0.729 [18.5]	0.670 [17]	0.591 [15]	0.742 [18.85]	
SC06	0.701 [17.8]	0.851 [21.6]	0.591 [15]	0.715 [18.15]	
SC07	0.894 [22.7]	0.654 [16.6]	0.591 [15]	0.907 [23.05]	

Size	W max.	H max.	LS ± 0.02 [±0.5]	δ ± 10%	T max.
SV01	0.402 [10.2]	0.378 [9.6]	0.400 [10.16]	0.024 [0.6]	Please, consult the tables of standard ratings
SV02	0.469 [11.9]	0.449 [11.4]	0.400 [10.16]	0.024 [0.6]	
SV04	0.650 [16.5]	0.552 [14]	0.600 [15.24]	0.035 [0.9]	
SV05	0.788 [20]	0.654 [16.6]	0.701 [17.8]	0.035 [0.9]	
SV06	0.701 [17.8]	0.851 [21.6]	0.600 [15.24]	0.035 [0.9]	
SV07	0.894 [22.7]	0.654 [16.6]	0.800 [20.32]	0.035 [0.9]	

SC / SV Series

High Capacitance Stacked Capacitors

STANDARD RATINGS

Exxelia size code	2225								3033								Cap. code
	SC00								SC01 / SV01								
	50 V		100 V		200 V		500 V		50 V		100 V		200 V		500 V		
Dielectric code	X	T	X	T	X	T	X	T	X	T	X	T	X	T	X	T	
	47nf							0.118 (3)								0.083 (2.1)	
56							0.118 (3)								0.083 (2.1)		563
68							0.118 (3)								0.083 (2.1)		683
82							0.118 (3)								0.083 (2.1)		823
100					0.039 (1.8)		0.118 (3)	0.079 (2.3)					0.083 (2.1)		0.098 (2.5)	0.102 (2.6)	104
120					0.039 (1.8)		0.118 (3)	0.079 (2.3)					0.083 (2.1)		0.098 (2.5)	0.102 (2.6)	124
150					0.079 (2)		0.252 (6.4)	0.079 (2.3)					0.083 (2.1)		0.098 (2.5)	0.102 (2.6)	154
180	0.039 (1.8)		0.039 (1.8)		0.079 (2)		0.252 (6.4)	0.102 (2.6)	0.083 (2.1)		0.083 (2.1)		0.083 (2.1)		0.126 (3.2)	0.102 (2.6)	184
220	0.039 (1.8)		0.039 (1.8)		0.098 (2.5)		0.252 (6.4)	0.110 (2.8)	0.083 (2.1)		0.083 (2.1)		0.083 (2.1)		0.126 (3.2)	0.102 (2.6)	224
270	0.039 (1.8)		0.039 (1.8)		0.098 (2.5)	0.079 (2.3)	0.378 (9.6)	0.122 (3.1)	0.083 (2.1)		0.083 (2.1)		0.083 (2.1)		0.138 (3.5)	0.102 (2.6)	274
330	0.039 (1.8)		0.039 (1.8)		0.118 (3)	0.079 (2.3)	0.378 (9.6)	0.252 (6.4)	0.083 (2.1)		0.083 (2.1)		0.083 (2.1)		0.241 (6.1)	0.110 (2.8)	334
390	0.039 (1.8)		0.039 (1.8)		0.118 (3)	0.079 (2.3)	0.504 (12.8)	0.252 (6.4)	0.083 (2.1)		0.083 (2.1)		0.083 (2.1)		0.241 (6.1)	0.122 (3.1)	394
470	0.039 (1.8)		0.039 (1.8)		0.213 (5.4)	0.079 (2.3)	0.504 (12.8)	0.252 (6.4)	0.083 (2.1)		0.083 (2.1)		0.083 (2.1)	0.079 (2.3)	0.272 (6.9)	0.138 (3.5)	474
560	0.079 (2)		0.079 (2)		0.232 (5.9)	0.098 (2.5)	0.551 (14)	0.252 (6.4)	0.083 (2.1)		0.083 (2.1)		0.098 (2.5)	0.079 (2.3)	0.414 (10.5)	0.237 (6)	564
680	0.079 (2)	0.079 (2.3)	0.079 (2)	0.079 (2.3)	0.252 (6.4)	0.110 (2.8)	0.630 (16)	0.382 (9.7)	0.083 (2.1)		0.083 (2.1)		0.118 (3)	0.079 (2.3)	0.414 (10.5)	0.249 (6.3)	684
820	0.079 (2)	0.079 (2.3)	0.079 (2)	0.079 (2.3)	0.319 (8.1)	0.197 (5)	0.709 (18)	0.382 (9.7)	0.083 (2.1)		0.083 (2.1)		0.138 (3.5)	0.094 (2.4)	0.548 (13.9)	0.260 (6.6)	824
1 µF	0.087 (2.2)	0.079 (2.3)	0.087 (2.2)	0.079 (2.3)	0.378 (9.6)	0.213 (5.4)		0.512 (13)	0.098 (2.5)		0.098 (2.5)		0.174 (4.4)	0.102 (2.6)	0.583 (14.8)	0.292 (7.4)	105
1.2	0.098 (2.5)	0.079 (2.3)	0.098 (2.5)	0.079 (2.3)	0.504 (12.8)	0.236 (6)			0.098 (2.5)		0.098 (2.5)		0.213 (5.4)	0.114 (2.9)	0.669 (17.6)	0.390 (9.9)	125
1.5	0.118 (3)	0.079 (2.3)	0.118 (3)	0.079 (2.3)	0.551 (14)	0.315 (8.1)			0.110 (2.8)	0.079 (2.3)	0.110 (2.8)	0.079 (2.3)	0.260 (6.6)	0.134 (3.4)		0.438 (11.1)	155
1.8	0.173 (4.4)	0.079 (2.3)	0.173 (4.4)	0.079 (2.3)	0.630 (16.4)	0.354 (9)			0.110 (2.8)	0.079 (2.3)	0.110 (2.8)	0.079 (2.3)	0.347 (8.8)	0.256 (6.5)		0.583 (14.8)	185
2.2	0.197 (5.1)	0.102 (2.6)	0.197 (5.1)	0.102 (2.6)	0.630 (16.4)	0.394 (10.8)			0.110 (2.8)	0.079 (2.3)	0.110 (2.8)	0.079 (2.3)	0.426 (10.8)	0.256 (6.5)		0.630 (16)	225
2.7	0.232 (5.9)	0.114 (2.9)	0.232 (5.9)	0.114 (2.9)		0.472 (12)			0.130 (3.3)	0.094 (2.4)	0.130 (3.3)	0.094 (2.4)	0.552 (14)	0.256 (6.5)			275
3.3	0.296 (7.5)	0.197 (5)	0.296 (7.5)	0.197 (5)		0.535 (13.6)			0.150 (3.8)	0.098 (2.5)	0.150 (3.8)	0.098 (2.5)	0.591 (15)	0.367 (9.3)			335
3.9	0.339 (8.6)	0.209 (5.3)	0.339 (8.6)	0.209 (5.3)					0.237 (6)	0.110 (2.8)	0.237 (6)	0.110 (2.8)		0.394 (10)			395
4.7	0.378 (9.6)	0.232 (5.9)	0.378 (9.6)	0.232 (5.9)					0.237 (6)	0.122 (3.1)	0.237 (6)	0.122 (3.1)		0.489 (12.4)			475
5.6	0.484 (12.3)	0.244 (6.2)	0.484 (12.3)	0.244 (6.2)					0.276 (7)	0.205 (5.2)	0.276 (7)	0.205 (5.2)		0.536 (13.6)			565
6.8	0.504 (12.8)	0.335 (8.5)	0.504 (12.8)	0.335 (8.5)					0.315 (8)	0.213 (5.4)	0.315 (8)	0.213 (5.4)					685
8.2	0.630 (16)	0.343 (8.7)	0.630 (16)	0.343 (8.7)					0.434 (11)	0.237 (6)	0.434 (11)	0.237 (6)					825
10		0.472 (12.2)		0.472 (12.2)					0.473 (12)	0.319 (8.1)	0.473 (12)	0.319 (8.1)					106
12		0.472 (12.2)		0.472 (12.2)					0.552 (14)	0.355 (9)	0.552 (14)	0.355 (9)					126
15										0.473 (12)		0.473 (12)					156
18										0.520 (13.2)		0.520 (13.2)					186

The thickness H max in inches (in mm) for the SC Series or the height T max in inches (in mm) for the SV Series is indicated in the cells.

High Capacitance Stacked Capacitors

SC / SV Series

STANDARD RATINGS

Exxelia size code	3740								5550								Cap. code	
	SC02 / SV02								SC04 / SV04									
	50 V		100 V		200 V		500 V		50 V		100 V		200 V		500 V			
Dielectric code	X	T	X	T	X	T	X	T	X	T	X	T	X	T	X	T		
100nf								0.118 (3)									104	
120								0.118 (3)									124	
150								0.118 (3)									154	
180					0.083 (2.1)			0.118 (3)	0.102 (2.6)								184	
220					0.083 (2.1)			0.118 (3)	0.102 (2.6)								224	
270					0.083 (2.1)			0.118 (3)	0.102 (2.6)					0.098 (2.5)	0.102 (2.6)		274	
330	0.083 (2.1)		0.083 (2.1)		0.083 (2.1)			0.130 (3.3)	0.102 (2.6)					0.098 (2.5)	0.102 (2.6)		334	
390	0.083 (2.1)		0.083 (2.1)		0.083 (2.1)			0.138 (3.5)	0.102 (2.6)					0.098 (2.5)	0.102 (2.6)		394	
470	0.083 (2.1)		0.083 (2.1)		0.083 (2.1)			0.157 (4)	0.102 (2.6)					0.118 (3)	0.102 (2.6)		474	
560	0.083 (2.1)		0.083 (2.1)		0.083 (2.1)			0.169 (4.3)	0.114 (2.9)					0.118 (3)	0.102 (2.6)		564	
680	0.083 (2.1)		0.083 (2.1)		0.098 (2.5)			0.276 (7)	0.134 (3.4)					0.118 (3)	0.102 (2.6)		684	
820	0.083 (2.1)		0.083 (2.1)		0.098 (2.5)	0.079 (2.3)		0.390 (9.9)	0.150 (3.8)				0.118 (3)	0.138 (3.5)	0.102 (2.6)		824	
1 µF	0.083 (2.1)		0.083 (2.1)		0.118 (3)	0.079 (2.3)		0.406 (10.3)	0.245 (6.2)				0.118 (3)	0.165 (4.2)	0.110 (2.8)		105	
1.2	0.083 (2.1)		0.083 (2.1)		0.138 (3.5)	0.079 (2.3)		0.552 (14)	0.245 (6.2)				0.118 (3)	0.102 (2.6)	0.252 (6.4)	0.130 (3.3)	125	
1.5	0.083 (2.1)	0.079 (2.3)	0.083 (2.1)	0.079 (2.3)	0.157 (4)	0.102 (2.6)		0.630 (16)	0.300 (7.6)				0.118 (3)	0.102 (2.6)	0.378 (9.6)	0.142 (3.6)	155	
1.8	0.098 (2.5)	0.079 (2.3)	0.098 (2.5)	0.079 (2.3)	0.233 (5.9)	0.111 (2.8)		0.709 (18)	0.315 (8)	0.098 (2.5)		0.098 (2.5)	0.118 (3)	0.102 (2.6)	0.378 (9.6)	0.157 (4.1)	185	
2.2	0.098 (2.5)	0.079 (2.3)	0.098 (2.5)	0.079 (2.3)	0.252 (6.4)	0.126 (3.2)		0.709 (18)	0.426 (10.8)	0.098 (2.5)		0.098 (2.5)	0.118 (3)	0.102 (2.6)	0.378 (9.6)	0.256 (6.5)	225	
2.7	0.110 (2.8)	0.079 (2.3)	0.110 (2.8)	0.079 (2.3)	0.252 (6.4)	0.142 (3.6)			0.567 (14.4)	0.098 (2.5)		0.098 (2.5)	0.138 (3.5)	0.102 (2.6)	0.504 (12.8)	0.288 (7.3)	275	
3.3	0.110 (2.8)	0.079 (2.3)	0.110 (2.8)	0.079 (2.3)	0.378 (9.6)	0.229 (5.8)		0.630 (16)		0.098 (2.5)	0.102 (2.6)	0.098 (2.5)	0.102 (2.6)	0.157 (4)	0.111 (2.8)	0.583 (14.8)	0.319 (8.1)	335
3.9	0.130 (3.3)	0.079 (2.3)	0.130 (3.3)	0.079 (2.3)	0.378 (9.6)	0.252 (6.4)				0.098 (2.5)	0.102 (2.6)	0.098 (2.5)	0.102 (2.6)	0.252 (6.4)	0.122 (3.1)	0.662 (16.8)	0.438 (11.1)	395
4.7	0.138 (3.5)	0.079 (2.3)	0.138 (3.5)	0.079 (2.3)	0.504 (12.8)	0.284 (7.2)				0.118 (3)	0.102 (2.6)	0.118 (3)	0.102 (2.6)	0.378 (9.6)	0.138 (3.5)		0.449 (11.4)	475
5.6	0.142 (3.6)	0.102 (2.6)	0.142 (3.6)	0.102 (2.6)	0.630 (16)	0.300 (7.6)				0.118 (3)	0.102 (2.6)	0.118 (3)	0.102 (2.6)	0.378 (9.6)	0.221 (5.6)		0.587 (14.9)	565
6.8	0.185 (4.7)	0.118 (3)	0.185 (4.7)	0.118 (3)	0.709 (18)	0.418 (10.6)				0.118 (3)	0.102 (2.6)	0.118 (3)	0.102 (2.6)	0.434 (11)	0.237 (6)		0.658 (16.7)	685
8.2	0.284 (7.2)	0.142 (3.6)	0.284 (7.2)	0.142 (3.6)		0.449 (11.4)				0.138 (3.5)	0.102 (2.6)	0.138 (3.5)	0.102 (2.6)	0.438 (11.1)	0.252 (6.4)			825
10	0.292 (7.4)	0.197 (5)	0.292 (7.4)	0.197 (5)		0.583 (14.8)				0.150 (3.8)	0.102 (2.6)	0.150 (3.8)	0.102 (2.6)	0.497 (12.6)	0.371 (9.4)			106
12	0.414 (10.5)	0.221 (5.6)	0.414 (10.5)	0.221 (5.6)						0.252 (6.4)	0.111 (2.8)	0.252 (6.4)	0.111 (2.8)	0.630 (16)	0.390 (9.9)			126
15	0.438 (11.1)	0.308 (7.8)	0.438 (11.1)	0.308 (7.8)						0.284 (7.2)	0.126 (3.2)	0.319 (8.1)	0.126 (3.2)		0.520 (13.2)			156
18	0.583 (14.8)	0.347 (8.8)	0.583 (14.8)	0.347 (8.8)						0.304 (7.7)	0.221 (5.6)	0.394 (10.8)	0.221 (5.6)		0.567 (14.4)			186
22	0.598 (15.2)	0.402 (10.2)	0.598 (15.2)	0.402 (10.2)						0.315 (8)	0.229 (5.8)	0.504 (12.8)	0.229 (5.8)					226
27		0.441 (11.2)		0.441 (11.2)						0.461 (11.7)	0.245 (6.2)	0.504 (12.8)	0.245 (6.2)					276
33		0.591 (15)		0.591 (15)						0.473 (12)	0.339 (8.6)	0.583 (14.8)	0.339 (8.6)					336
39		0.630 (16)		0.630 (16)						0.630 (16)	0.371 (9.4)	0.662 (16.8)	0.371 (9.4)					396
47											0.473 (12)		0.473 (12)					476
56											0.536 (13.6)		0.536 (13.6)					566

HIGH CAPACITANCE

The thickness H max in inches (in mm) for the SC Series or the height T max in inches (in mm) for the SV Series is indicated in the cells.

SC / SV Series

High Capacitance Stacked Capacitors

STANDARD RATINGS

Exxelia size code	6560								6080 / 8060								Cap. code
	SC05 / SV05								SC06 / SC07 - SV06 / SV07								
	50 V		100 V		200 V		500 V		50 V		100 V		200 V		500 V		
Dielectric code	X	T	X	T	X	T	X	T	X	T	X	T	X	T	X	T	
270nf							0.098 (2.5)	0.102 (2.6)									274
330							0.098 (2.5)	0.102 (2.6)									334
390							0.098 (2.5)	0.102 (2.6)									394
470							0.098 (2.5)	0.102 (2.6)						0.118 (3)			474
560					0.098 (2.5)		0.098 (2.5)	0.102 (2.6)						0.118 (3)			564
680					0.098 (2.5)		0.098 (2.5)	0.102 (2.6)						0.118 (3)	0.102 (2.6)		684
820					0.098 (2.5)		0.118 (3)	0.102 (2.6)						0.118 (3)	0.102 (2.6)		824
1 µF	0.098 (2.5)		0.098 (2.5)		0.098 (2.5)	0.102 (2.6)	0.118 (3)	0.102 (2.6)						0.118 (3)	0.102 (2.6)		105
1.2	0.098 (2.5)		0.098 (2.5)		0.098 (2.5)	0.102 (2.6)	0.138 (3.5)	0.102 (2.6)						0.138 (3.5)	0.102 (2.6)		125
1.5	0.098 (2.5)		0.098 (2.5)		0.098 (2.5)	0.102 (2.6)	0.157 (4)	0.118 (3)					0.118 (3)	0.157 (4)	0.102 (2.6)		155
1.8	0.098 (2.5)		0.098 (2.5)		0.098 (2.5)	0.102 (2.6)	0.177 (4.5)	0.118 (3)					0.118 (3)	0.177 (4.5)	0.102 (2.6)		185
2.2	0.098 (2.5)		0.098 (2.5)		0.098 (2.5)	0.102 (2.6)	0.272 (6.9)	0.130 (3.3)					0.118 (3)	0.102 (2.6)	0.272 (6.9)	0.102 (2.6)	225
2.7	0.098 (2.5)	0.102 (2.6)	0.098 (2.5)	0.102 (2.6)	0.118 (3)	0.102 (2.6)	0.312 (7.9)	0.150 (3.8)					0.118 (3)	0.102 (2.6)	0.378 (9.6)	0.130 (3.3)	275
3.3	0.098 (2.5)	0.102 (2.6)	0.098 (2.5)	0.102 (2.6)	0.118 (3)	0.102 (2.6)	0.331 (8.4)	0.169 (4.3)					0.118 (3)	0.102 (2.6)	0.398 (10.1)	0.154 (3.9)	335
3.9	0.098 (2.5)	0.102 (2.6)	0.098 (2.5)	0.102 (2.6)	0.138 (3.5)	0.102 (2.6)	0.438 (11.1)	0.264 (6.7)	0.118 (3)		0.118 (3)		0.138 (3.5)	0.102 (2.6)	0.504 (12.8)	0.173 (4.4)	395
4.7	0.098 (2.5)	0.102 (2.6)	0.098 (2.5)	0.102 (2.6)	0.157 (4)	0.102 (2.6)	0.497 (12.6)	0.296 (7.5)	0.118 (3)		0.118 (3)		0.157 (4)	0.102 (2.6)	0.583 (14.8)	0.249 (6.3)	475
5.6	0.098 (2.5)	0.102 (2.6)	0.098 (2.5)	0.102 (2.6)	0.233 (5.9)	0.114 (2.9)	0.662 (16.8)	0.335 (8.5)	0.118 (3)		0.118 (3)		0.252 (6.4)	0.102 (2.6)	0.583 (14.8)	0.276 (7)	565
6.8	0.098 (2.5)	0.102 (2.6)	0.098 (2.5)	0.102 (2.6)	0.252 (6.4)	0.130 (3.3)	0.819 (20.8)	0.355 (9)	0.118 (3)	0.102 (2.6)	0.118 (3)	0.102 (2.6)	0.252 (6.4)	0.118 (3)	0.661 (16.8)	0.319 (8.1)	685
8.2	0.118 (3)	0.102 (2.6)	0.118 (3)	0.102 (2.6)	0.359 (9.1)	0.150 (3.8)		0.473 (12)	0.118 (3)	0.102 (2.6)	0.118 (3)	0.102 (2.6)	0.378 (9.6)	0.142 (3.6)	0.740 (18.8)	0.386 (9.8)	825
10	0.118 (3)	0.102 (2.6)	0.118 (3)	0.102 (2.6)	0.378 (9.6)	0.233 (5.9)		0.532 (13.5)	0.138 (3.5)	0.102 (2.6)	0.138 (3.5)	0.102 (2.6)	0.378 (9.6)	0.220 (5.6)		0.485 (12.3)	106
12	0.138 (3.5)	0.102 (2.6)	0.138 (3.5)	0.102 (2.6)	0.504 (12.8)	0.260 (6.6)		0.689 (17.5)	0.138 (3.5)	0.102 (2.6)	0.138 (3.5)	0.102 (2.6)	0.504 (12.8)	0.236 (6)		0.595 (15.1)	126
15	0.157 (4)	0.102 (2.6)	0.157 (4)	0.102 (2.6)	0.583 (14.8)	0.296 (7.5)			0.138 (3.5)	0.102 (2.6)	0.138 (3.5)	0.102 (2.6)	0.504 (12.8)	0.276 (7)		0.725 (18.4)	156
18	0.252 (6.4)	0.102 (2.6)	0.252 (6.4)	0.102 (2.6)		0.398 (10.1)			0.146 (3.7)	0.102 (2.6)	0.146 (3.7)	0.102 (2.6)	0.630 (16)	0.347 (8.8)			186
22	0.252 (6.4)	0.118 (3)	0.252 (6.4)	0.118 (3)		0.434 (11)			0.252 (6.4)	0.110 (2.8)	0.291 (7.4)	0.110 (2.8)	0.740 (18.8)	0.362 (9.2)			226
27	0.312 (7.9)	0.142 (3.6)	0.378 (9.6)	0.142 (3.6)		0.552 (14)			0.252 (6.4)	0.130 (3.3)	0.323 (8.2)	0.130 (3.3)	0.740 (18.8)	0.504 (12.8)			276
33	0.331 (8.4)	0.220 (5.6)	0.378 (9.6)	0.220 (5.6)		0.630 (16)			0.280 (7.1)	0.220 (5.6)	0.413 (10.5)	0.220 (5.6)		0.598 (15.2)			336
39	0.457 (11.6)	0.237 (6)	0.504 (12.8)	0.237 (6)					0.378 (9.6)	0.228 (5.8)	0.441 (11.2)	0.228 (5.8)		0.630 (16)			396
47	0.497 (12.6)	0.276 (7)	0.504 (12.8)	0.276 (7)					0.378 (9.6)	0.256 (6.5)	0.465 (11.8)	0.256 (6.5)					476
56	0.662 (16.8)	0.347 (8.8)	0.669 (17)	0.347 (8.8)					0.457 (11.6)	0.347 (8.8)	0.472 (12)	0.347 (8.8)					566
68		0.378 (9.6)		0.378 (9.6)					0.583 (14.8)	0.354 (9)	0.591 (15)	0.354 (9)					686
82		0.504 (12.8)		0.504 (12.8)						0.465 (11.8)		0.465 (11.8)					826
100		0.575 (14.6)		0.575 (14.6)						0.768 (19.5)		0.768 (19.5)					107

The thickness H max in inches (in mm) for the SC Series or the height T max in inches (in mm) for the SV Series is indicated in the cells.

High Capacitance Stacked Capacitors

SC / SV Series

STANDARD RATINGS

Excellia size code	45107								45214				80150				125205				Cap. code
	SC10								SC11				SC12				SC18				
	50 V		100 V		200 V		500 V		50 V	100 V	200 V	500 V	50 V	100 V	200 V	500 V	50 V	100 V	200 V	500 V	
Dielectric code	X	T	X	T	X	T	X	T	X	X	X	X	X	X	X	X	X	X	X	X	
680nf							0.138 (3.5)	0.122 (3.1)													684
820					0.118 (3)	0.118 (3)	0.138 (3.5)	0.122 (3.1)													824
1 µF	0.118 (3)		0.118 (3)		0.118 (3)	0.118 (3)	0.150 (3.8)	0.122 (3.1)													105
1.2	0.118 (3)		0.118 (3)		0.118 (3)	0.118 (3)	0.150 (3.8)	0.122 (3.1)													125
1.5	0.118 (3)	0.118 (3)	0.118 (3)	0.118 (3)	0.118 (3)	0.118 (3)	0.252 (6.4)	0.122 (3.1)													155
1.8	0.118 (3)	0.118 (3)	0.118 (3)	0.118 (3)	0.118 (3)	0.118 (3)	0.252 (6.4)	0.122 (3.1)													185
2.2	0.118 (3)	0.118 (3)	0.118 (3)	0.118 (3)	0.138 (3.5)	0.118 (3)	0.252 (6.4)	0.122 (3.1)													225
2.7	0.118 (3)	0.118 (3)	0.118 (3)	0.118 (3)	0.150 (3.8)	0.118 (3)	0.292 (7.4)	0.122 (3.1)				*							0.157 (4)		275
3.3	0.118 (3)	0.118 (3)	0.118 (3)	0.118 (3)	0.157 (4)	0.118 (3)	0.378 (9.6)	0.331 (8.4)				*							0.157 (4)		335
3.9	0.118 (3)	0.118 (3)	0.118 (3)	0.118 (3)	0.213 (5.4)	0.118 (3)	0.504 (12.8)	0.331 (8.4)				*							0.157 (4)		395
4.7	0.118 (3)	0.118 (3)	0.118 (3)	0.118 (3)	0.233 (5.9)	0.118 (3)	0.583 (14.8)	0.331 (8.4)				*							0.157 (4)		475
5.6	0.118 (3)	0.118 (3)	0.118 (3)	0.118 (3)	0.252 (6.4)	0.118 (3)	0.583 (14.8)	0.331 (8.4)				*							0.315 (8)		565
6.8	0.118 (3)	0.118 (3)	0.118 (3)	0.118 (3)	0.319 (8.1)	0.252 (6.4)	0.662 (16.8)	0.331 (8.4)				*							0.315 (8)		685
8.2	0.118 (3)	0.118 (3)	0.118 (3)	0.118 (3)	0.378 (9.6)	0.252 (6.4)		0.496 (12.6)				*	*					0.157 (4)	0.315 (8)		825
10	0.138 (3.5)	0.118 (3)	0.138 (3.5)	0.118 (3)	0.378 (9.6)	0.252 (6.4)		0.496 (12.6)				*	*					0.157 (4)	0.315 (8)		106
12	0.138 (3.5)	0.118 (3)	0.138 (3.5)	0.118 (3)	0.504 (12.8)	0.378 (9.6)		0.661 (16.8)			*	*	*					0.315 (8)	0.472 (12)		126
15	0.252 (6.4)	0.118 (3)	0.252 (6.4)	0.118 (3)	0.504 (12.8)	0.378 (9.6)					*	*						0.315 (8)	0.472 (12)		156
18	0.252 (6.4)	0.118 (3)	0.252 (6.4)	0.118 (3)	0.661 (16.8)	0.504 (12.8)					*	*			*			0.315 (8)	0.630 (16)		186
22	0.378 (9.6)	0.118 (3)	0.378 (9.6)	0.118 (3)		0.504 (12.8)					*	*			*			0.315 (8)	*		226
27	0.378 (9.6)	0.130 (3.3)	0.378 (9.6)	0.130 (3.3)		0.661 (16.8)				*	*	*			*			0.472 (12)	*		276
33	0.504 (12.8)	0.276 (7)	0.504 (12.8)	0.276 (7)						*	*	*					0.157 (4)	0.472 (12)	*		336
39	0.504 (12.8)	0.276 (7)	0.504 (12.8)	0.276 (7)						*	*				0.157 (4)	0.157 (4)	0.630 (16)			*	396
47	0.591 (15)	0.276 (7)	0.591 (15)	0.276 (7)						*	*				0.157 (4)	0.315 (8)	*		*	*	476
56	0.591 (15)	0.433 (11)	0.591 (15)	0.433 (11)						*	*				0.315 (8)	0.315 (8)	*		*	*	566
68		0.433 (11)		0.433 (11)						*	*				0.315 (8)	0.315 (8)			*	*	686
82		0.591 (15)		0.591 (15)						*					0.315 (8)	0.315 (8)		*	*	*	826
100										*					0.315 (8)	0.472 (12)		*	*	*	107
120										*					0.472 (12)	0.472 (12)		*	*		127
150															0.472 (12)	0.630 (16)		*	*		157
180															0.630 (16)			*	*		187
220																		*	*		227
270																		*			277
330																		*			337
390																		*			397

The thickness H max in inches (in mm) for the SC Series or the height T max in inches (in mm) for the SV Series is indicated in the cells. * Consult us

General Information

These capacitors have been developed in response to demand from switched mode power supply (S.M.P.S.) and DC-DC converters manufacturers. They are particularly suitable for filtering, smoothing and decoupling purpose in Hi-Rel equipments. The capacitors utilize advanced ceramic technology to achieve Hi-Rel long operating life and small size. They are designed for hybrid assemblies and low profile printed circuit applications.

Customized assemblies may be achieved with standard bare chip sizes mentioned in the following chapters.

TYPICAL CURVES: R Series, SC/SV Series

X DIELECTRIC: TYPICAL VOLTAGE COEFFICIENT AT 25°C (FOR ALL SIZES)

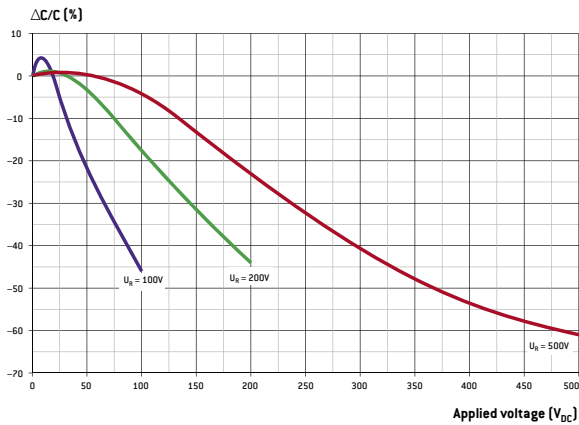

T DIELECTRIC: TYPICAL VOLTAGE COEFFICIENT AT 25°C (for all sizes)

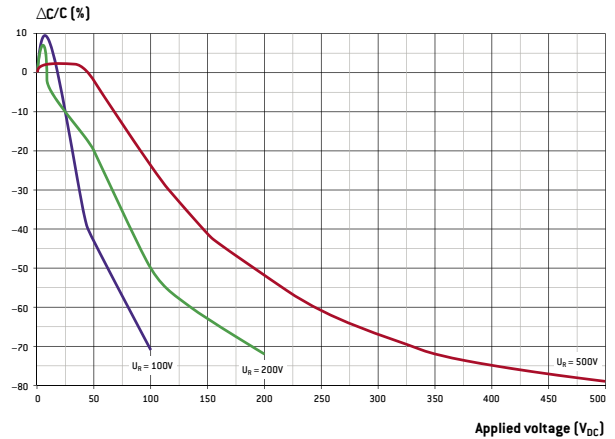

X DIELECTRIC: TYPICAL TEMPERATURE COEFFICIENT WITHOUT VOLTAGE (for all sizes)

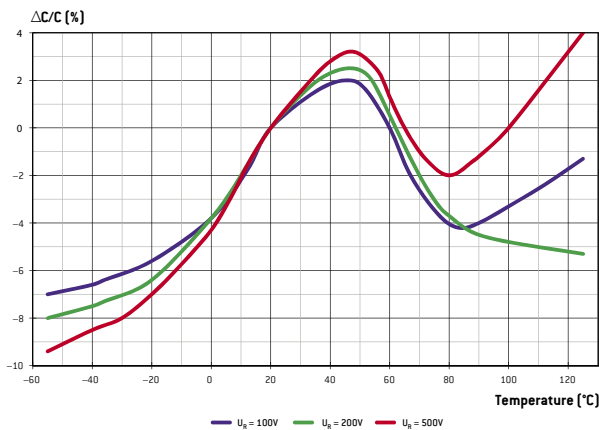

T DIELECTRIC: TYPICAL TEMPERATURE COEFFICIENT WITHOUT VOLTAGE (for all sizes)

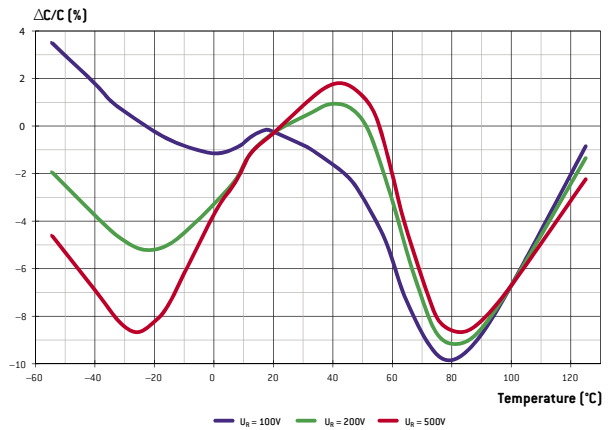

General Information

TYPICAL CURVES: R Series, SC/SV Series

TYPICAL ESR VS FREQUENCY

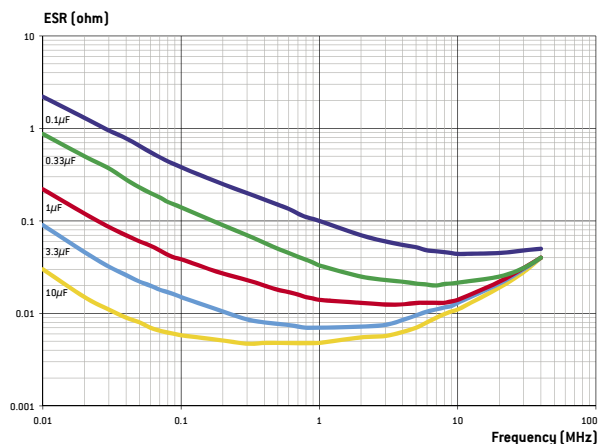

The ESR (Equivalent Serial Resistance) curves are given here for SMD (chips all case sizes) capacitors. Regarding the curves for the leaded capacitors, they are rather the same. Indeed, due to the resistivity of the raw material used and the wire diameters, the resistance of the wires is much lower than the ESR of the chips. So, in a first approach, their influence can be considered as negligible.

TYPICAL ESR VS FREQUENCY

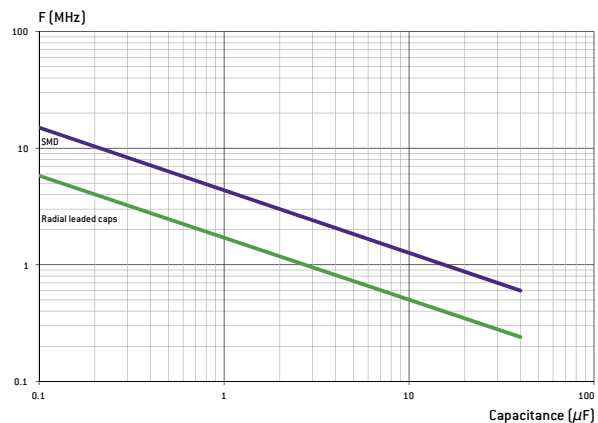

TYPICAL MAXIMUM ADMISSIBLE CURRENT VS FREQUENCY

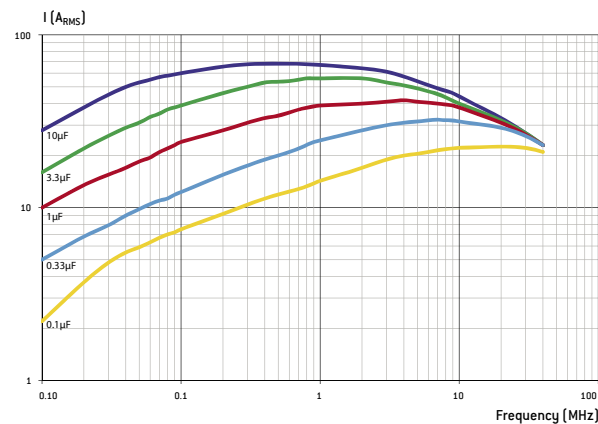

These typical curves are an example of admissible currents for one family of chip capacitors: 501R3740X chip series. For other curves and products or for further information, please contact us. Note: for the calculations, we have considered that the terminations are directly connected to an infinite heat sink. In other words, the thermal resistance of the circuit itself which depends of its type and design has not been taken into account. Moreover, the ambient temperature taken is 25°C.

HIGH CAPACITANCE

General Information

TYPICAL CURVES: CNC3X Series

TYPICAL TEMPERATURE COEFFICIENT

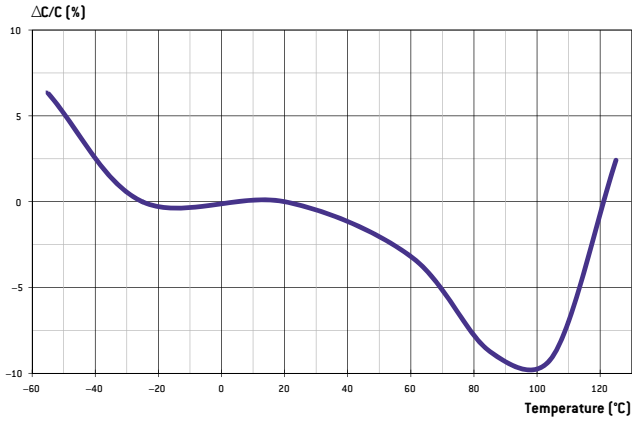

TYPICAL VOLTAGE COEFFICIENT

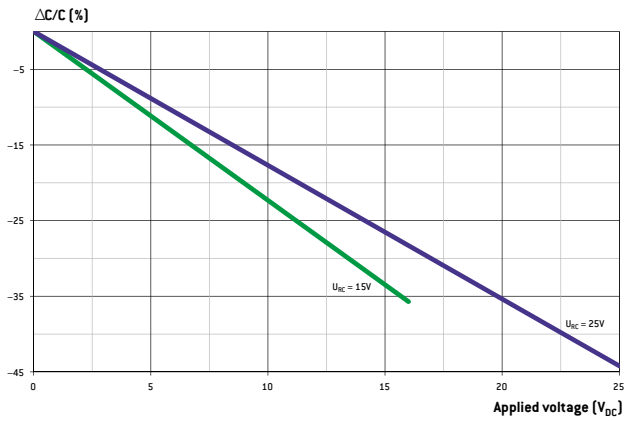

MAXIMUM CURRENT VS FREQUENCY

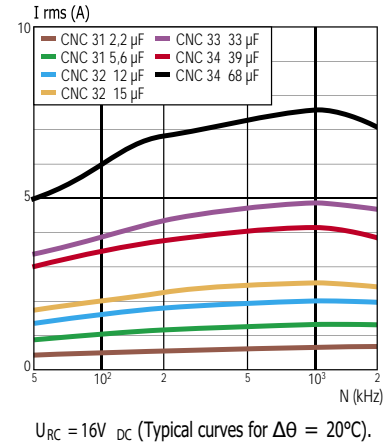

$U_{RC} = 16V_{DC}$ (Typical curves for $\Delta\theta = 20^\circ C$).

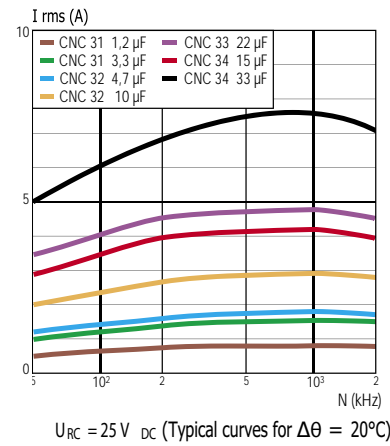

$U_{RC} = 25V_{DC}$ (Typical curves for $\Delta\theta = 20^\circ C$).

General Information

TYPICAL CURVES: CEC5X Series

NPO: CURRENT VS FREQUENCY

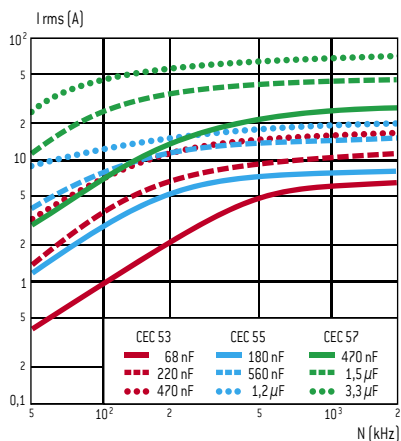

$U_{RC} = 63 V_{DC}$ (Typical curve for $\Delta\theta = 20^\circ C$).

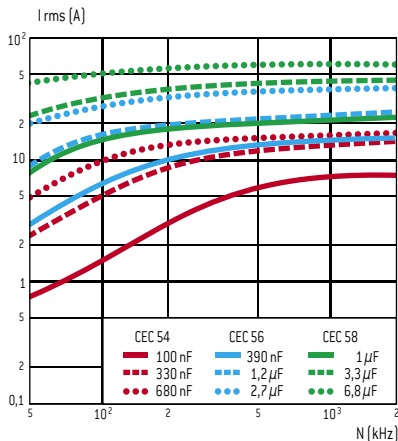

$U_{RC} = 63 V_{DC}$ (Typical curve for $\Delta\theta = 20^\circ C$).

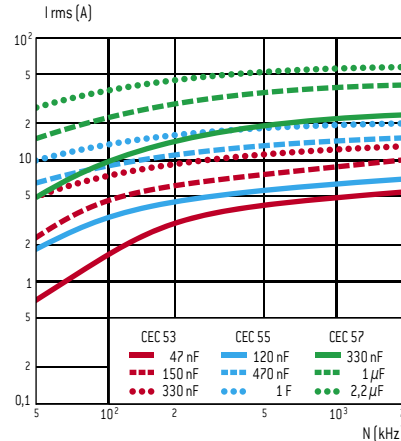

$U_{RC} = 100 V_{DC}$ (Typical curve for $\Delta\theta = 20^\circ C$).

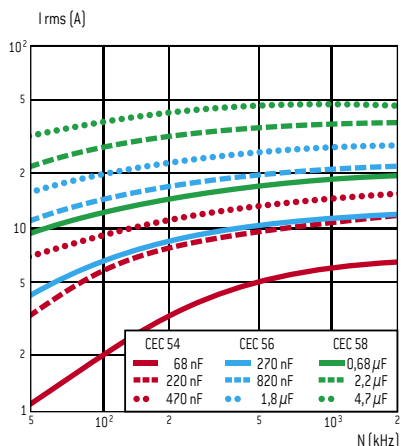

$U_{RC} = 100 V_{DC}$ (Typical curve for $\Delta\theta = 20^\circ C$).

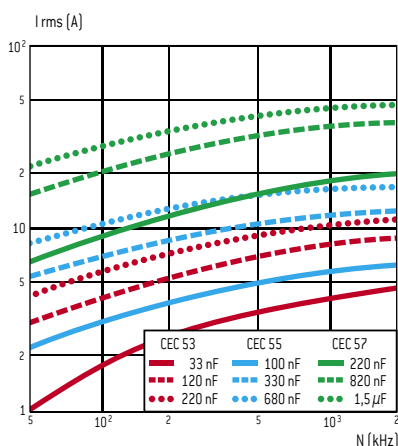

$U_{RC} = 200 V_{DC}$ (Typical curve for $\Delta\theta = 20^\circ C$).

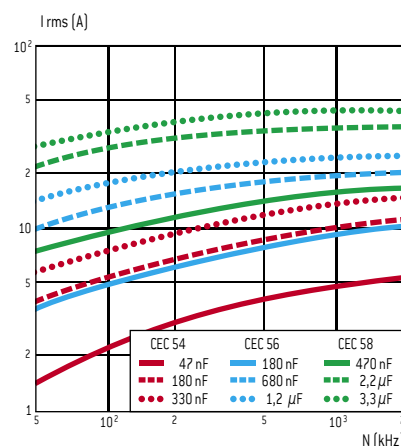

$U_{RC} = 200 V_{DC}$ (Typical curve for $\Delta\theta = 20^\circ C$).

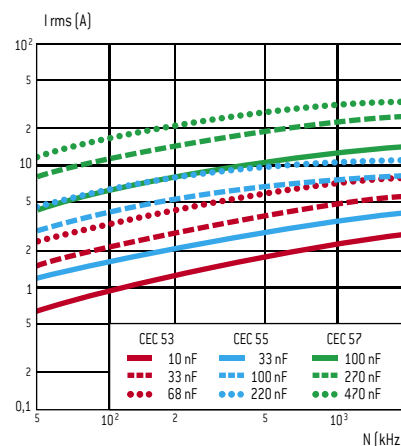

$U_{RC} = 500 V_{DC}$ (Typical curve for $\Delta\theta = 20^\circ C$).

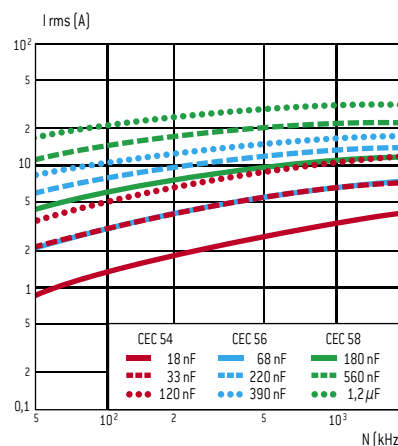

$U_{RC} = 500 V_{DC}$ (Typical curve for $\Delta\theta = 20^\circ C$).

HIGH CAPACITANCE

General Information

TYPICAL CURVES: TCN8X Series

TCN83: TYPICAL EQUIVALENT SERIAL RESISTANCE (ESR) VS FREQUENCY (N)

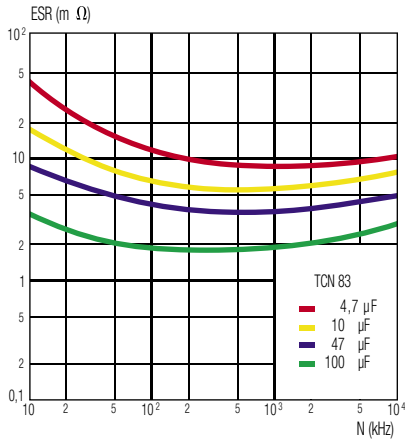

TCN86: TYPICAL EQUIVALENT SERIAL RESISTANCE (ESR) VS FREQUENCY (N)

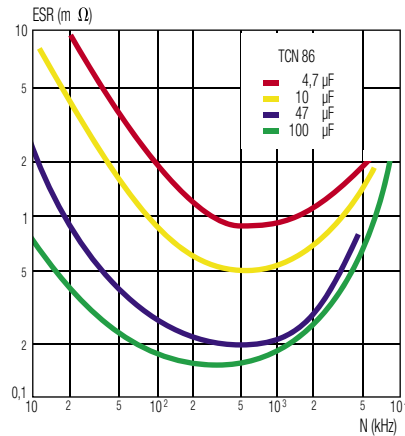

TCN87: TYPICAL EQUIVALENT SERIAL RESISTANCE (ESR) VS FREQUENCY (N)

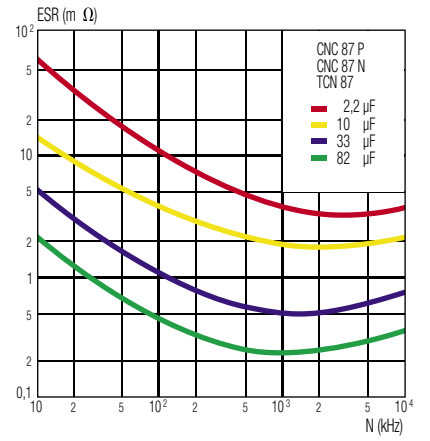

TCN83: CURRENT (I_{RMS}) VS FREQUENCY (N) TYPICAL CURVES FOR Δθ ≤ 20°C

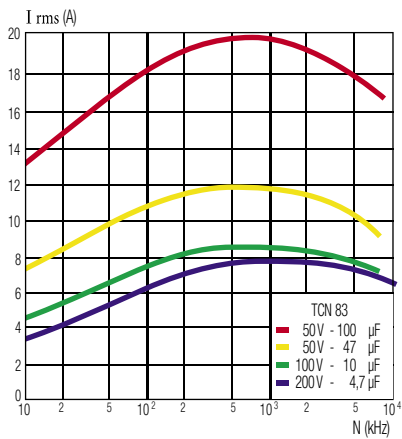

TCN86: CURRENT (I_{RMS}) VS FREQUENCY (N) TYPICAL CURVES FOR Δθ ≤ 20°C

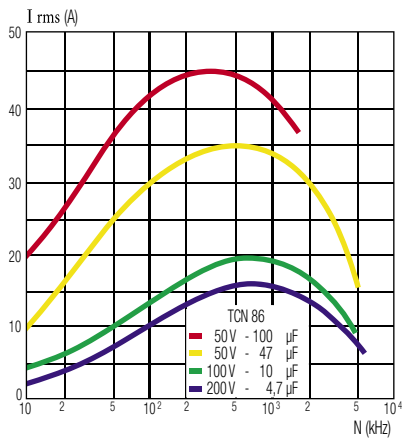

TCN87: CURRENT (I_{RMS}) VS FREQUENCY (N) TYPICAL CURVES FOR Δθ ≤ 20°C

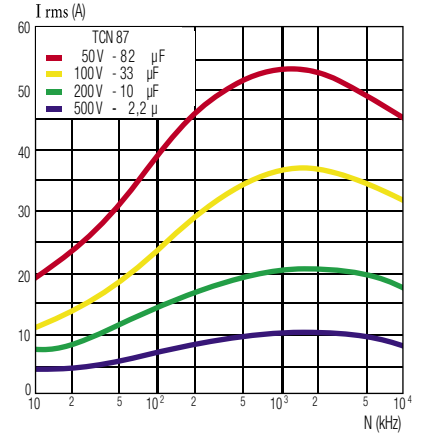

Ceramic Capacitors Technology

MLCC STRUCTURE

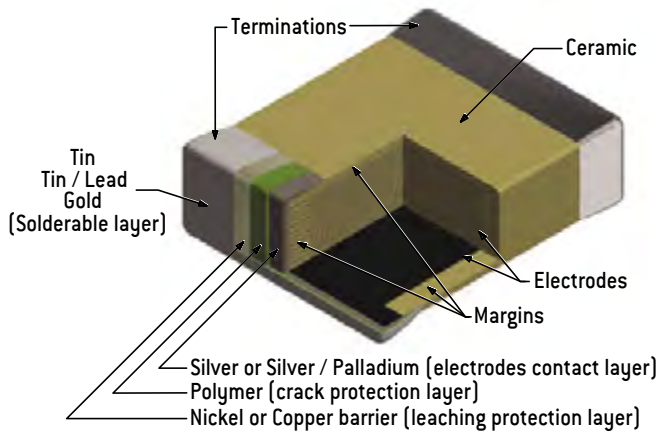

EQUIVALENT CIRCUIT

Capacitor is a complex component combining resistive, inductive and capacitive phenomena. A simplified schematic for the equivalent circuit is:

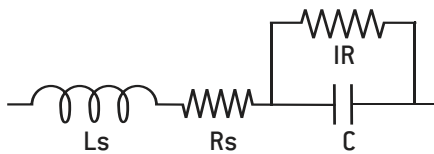

DIELECTRIC CHARACTERISTICS

Insulation Resistance (IR) is the resistance measured under DC voltage across the terminals of the capacitor and consists principally of the parallel resistance shown in the equivalent circuit. As capacitance values and hence the area of dielectric increases, the IR decreases and hence the product $[C \times IR]$ is often specified in $\Omega \cdot F$ or $M\Omega \cdot \mu F$.

The Equivalent Series Resistance (ESR) is the sum of the resistive terms which generate heating when capacitor is used under AC voltage at a given frequency (f) .

Dissipation factor (DF) is the ration of the apparent power input will turn to heat in the capacitor:

$$DF = 2\pi f C ESR$$

When a capacitor works under AC voltage, **heat power loss (P)**, expressed in Watt, is equal to:

$$P = 2\pi f C V_{rms}^2 DF$$

The series inductance (Ls) is due to the currents running through the electrodes. It can distort the operation of the capacitor at high frequency where the **impedance (Z)** is given as:

$$Z = R_s + j [L_s \cdot \omega - 1/(C \cdot \omega)] \text{ with } \omega = 2\pi f$$

When frequency rises, the capacitive component of capacitors is gradually canceled up to the resonance frequency, where :

$$Z = R_s \text{ and } L_s C \cdot \omega^2 = 1$$

Above this frequency the capacitor behaves like an inductor.

	P100	NPO	N2200 (C4xx)	BX	2C1	X7R
Dielectric material	Porcelain	Magnesium titanate or Neodymium baryum titanate	Barium zirconate titanate	Baryum titanate (BaTiO ₃)		
Dielectric constant	15 – 18	20 – 85	450	2,000 – 5,000		
Electrode technology	PME (Precious Metal Electrodes): Ag/Pd					
Capacitance variation between –55°C and +125°C without DC voltage	[100±30]ppm/°C	[0±30]ppm/°C	[–2,200±500] ppm/°C	±15%	±20%	±15%
Capacitance variation between –55°C and +125°C with DC rated voltage			0-15%	15%–25%	20%–30%	Not applicable
Piezo-electric effect	None		None	Yes		
Dielectric absorption	None		Few %	Few %		
Thermal shock sensitive	+		+	++		

Ceramic Capacitors Technology

MANUFACTURING STEPS

SLIP CASTING



A slurry, a mix of ceramic powder, binder and solvents, is poured onto conveyor belt inside a drying oven, resulting in a dry ceramic sheet.

ELECTRODE SCREEN PRINTING

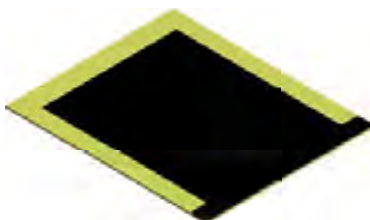

The electrode ink, made from a metal powder mixed with solvents, is printed onto the ceramic sheets using a screen printing process.

STACKING

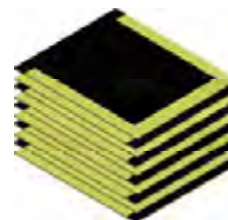

The sheets with electrode printed are stacked to create a multilayer structure.

TERMINATIONS

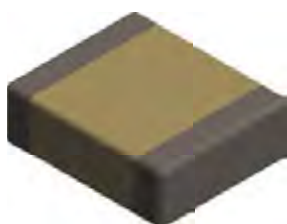

Each terminal of the capacitor is dipped in the termination ink, mix of metal powder, solvents and glass frit and the parts are fired in an oven.

SINTERING

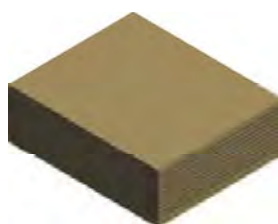

The parts are sintered in an oven with a precise temperature profile which is very important to the characteristics of the capacitors.

PRESSING

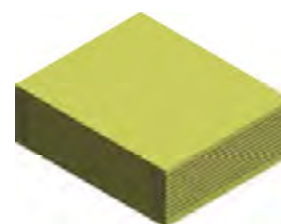

Pressure is applied to the stack to fuse all the separate layers, this created a monolithic structure.

TERMINATIONS PLATING

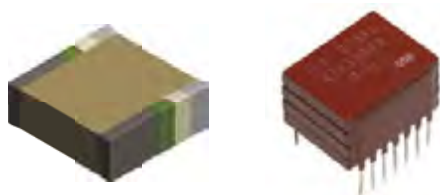

Stacking + leads soldering + encapsulation
[see pages 10-11]

FINAL TESTING

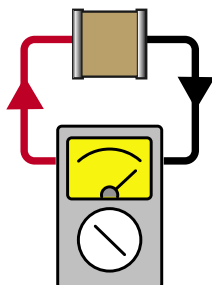

PACKAGING



User Guide

SMD TERMINATIONS

NON RoHS COMPLIANT	Code	RoHS COMPLIANT	Code	Recommended mounting process							Storage (months)*
				Magnetic	Epoxy bonding	Iron soldering	Wave soldering	Vapor phase soldering	Infrared soldering	Wire bonding	
Ag	Q	Ag	QW / P	No	•	•	•	•			18
Ag/Pd/Pt	-	Ag/Pd/Pt	W / A	No	•	•	•				24
Ag/Pd/Pt + dipped Sn/Pb 60/40	H	Ag/Pd/Pt + dipped Sn	HW	No		•					24
Ag + Ni + electrolytic Sn/Pb 95/5	C	Ag + Ni + electrolytic Sn	CW / S	Yes		•	•	•	•		18
Ag + Ni + electrolytic Sn/Pb 60/40	D	-	-	Yes		•	•	•	•		18
-	-	Ag + Cu + electrolytic Sn	C**	No		•	•	•	•		18
Ag + Ni + dipped Sn/Pb 60/40	E	-	-	Yes		•	•				24
Ag + Ni + Au	G	Ag + Ni + Au	GW	Yes	•	•	•	•	•	•	36
Ag + Polymer + Ni + Sn/Pb 95/5	YC	Ag + Polymer + Ni + Sn	YCW	Yes		•	•	•	•		18
Ag + Polymer + Ni + Sn/Pb 60/40	YD	-	-	Yes		•	•	•	•		18
Ag + Polymer + Ni + Au	YG	Ag + Polymer + Ni + Au	YGW	Yes	•	•	•	•	•	•	36

Nickel (Ni) or Copper (Cu) barriers amplify thermal shock and are not recommended for chip sizes larger than 3030.

* Storage must be in a dry environment at a temperature of 20°C with a relative humidity below 50%, or preferably in a package enclosing a desiccant.

** Non magnetic chips series only.

SMD ENVIRONMENTAL TESTS

Ceramic chip capacitors for SMD are designed to meet test requirements of **CECC 32100** and **NF C 93133** standards as specified below in compliance with **NF C 20700** and **IEC 68** standards:

- Solderability: **NF C 20758**, 260°C, bath 62/36/2.
- Adherence: 5N force.
- Vibration fatigue test: **NF C 20706**, 20 g, 10 Hz to 2,000 Hz, 12 cycles of 20 minutes each.
- Rapid temperature change: **NF C 20714**, -55°C to + 125°C, 5 cycles.
- Combined climatic test: **IEC 68-2-38**.
- Damp heat: **NF C 20703**, 93 %, H.R., 40°C.
- Endurance test: 1,000 hours, 1.5 U_{RC}, 125°C.

STORAGE OF CHIP CAPACITORS

TINNED OR NON TINNED CHIP CAPACITORS

Storage must be in a dry environment at a temperature of 20°C with a relative humidity below 50 %, or preferably in a packaging enclosing a desiccant.

STORAGE IN INDUSTRIAL ENVIRONMENT:

- 2 years for tin dipped chip capacitors,
- 18 months for tin electroplated chip capacitors,
- 2 years for non tinned chip capacitors,
- 3 years for gold plated chip capacitors.

STORAGE IN CONTROLLED NEUTRAL NITROGEN ENVIRONMENT:

- 4 years for tin dipped or electroplated chip capacitors,
- 4 years for non tinned chip capacitors,
- 5 years for gold plated chip capacitors.

Storage duration should be considered from delivery date and not from batch manufacture date. The tests carried out at final acceptance stage [solderability, susceptibility to solder heat] enable to assess the compatibility to surface mounting of the chips.

User Guide

LEAD STYLES

SURFACE MOUNTING

DIL LEADS

P style



PL style



L style



J style



RIBBON LEADS

Micro-strip (type 1)
Short Micro-strip (type 1S)

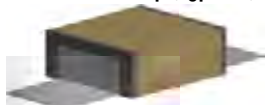

Axial (Type 2)

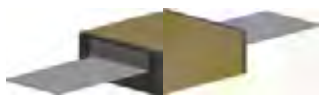

Radial (Type 3)



R style



RX style



RJ style



Please contact Exxelia sales for any lead configuration not shown.

TROUGH-HOLE MOUNTING

AXIAL AND RADIAL

Radial leads (Type 6)



Radial leads (4 leads)



Axial leads (Type 7)



DIL leads: N style



ENCAPSULATION STYLES

Ceramic encapsulation
(selfprotected)



Varnish



Conformal coating



Molding



User Guide

SOLDERING ADVICES FOR REFLOW SOLDERING

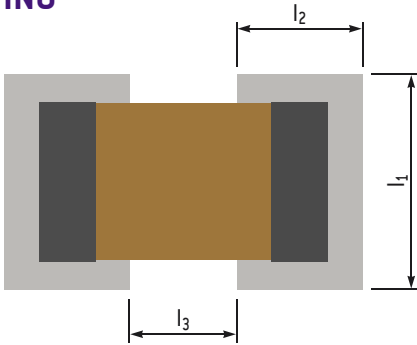

Large chips above size 2225 are not recommended to be mounted on epoxy board due to thermal expansion coefficient mismatch between ceramic capacitor and epoxy. Where larger sizes are required, it is recommended to use components with ribbon or other adapted leads so as to absorb thermo-mechanical strains.

Dimensions in inches (in mm)	Reflow soldering						Wave soldering					
	l ₁		l ₂		l ₃		l ₁		l ₂		l ₃	
0402	0.043	(1.1)	0.035	(0.9)	0.012	(0.3)	0.043	(1.1)	0.047	(1.2)	0.012	(0.3)
0403	0.055	(1.4)	0.035	(0.9)	0.012	(0.3)	0.055	(1.4)	0.047	(1.2)	0.012	(0.3)
0504	0.063	(1.6)	0.051	(1.3)	0.016	(0.4)	0.063	(1.6)	0.063	(1.6)	0.016	(0.4)
0603	0.055	(1.4)	0.059	(1.5)	0.02	(0.5)	0.055	(1.4)	0.071	(1.8)	0.02	(0.5)
0805	0.073	(1.85)	0.065	(1.65)	0.024	(0.6)	0.073	(1.85)	0.077	(1.95)	0.024	(0.6)
0907	0.094	(2.4)	0.065	(1.65)	0.035	(0.9)	0.094	(2.4)	0.077	(1.95)	0.035	(0.9)
1005	0.073	(1.85)	0.067	(1.7)	0.039	(1)	0.073	(1.85)	0.079	(2)	0.039	(1)
1206	0.083	(2.1)	0.067	(1.7)	0.059	(1.5)	0.083	(2.1)	0.079	(2)	0.059	(1.5)
1210	0.118	(3)	0.069	(1.75)	0.059	(1.5)	0.118	(3)	0.081	(2.05)	0.059	(1.5)
1605	0.073	(1.85)	0.071	(1.8)	0.087	(2.2)	0.073	(1.85)	0.083	(2.1)	0.087	(2.2)
1806	0.087	(2.2)	0.073	(1.85)	0.102	(2.6)	0.087	(2.2)	0.085	(2.15)	0.102	(2.6)
1812	0.152	(3.85)	0.073	(1.85)	0.102	(2.6)	0.152	(3.85)	0.085	(2.15)	0.102	(2.6)
1825	0.281	(7.15)	0.073	(1.85)	0.102	(2.6)	0.281	(7.15)	0.085	(2.15)	0.102	(2.6)
2210	0.13	(3.3)	0.079	(2)	0.146	(3.7)	0.13	(3.3)	0.091	(2.3)	0.146	(3.7)
2220	0.228	(5.8)	0.079	(2)	0.146	(3.7)	0.228	(5.8)	0.091	(2.3)	0.146	(3.7)
2225	0.281	(7.15)	0.079	(2)	0.146	(3.7)	0.281	(7.15)	0.091	(2.3)	0.146	(3.7)

RECOMMENDED FOOTPRINT FOR SMD CAPACITORS

Ceramic is by nature a material which is sensitive both thermally and mechanically. Stresses caused by the physical and thermal properties of the capacitors, substrates and solders are attenuated by the leads.

Wave soldering is unsuitable for sizes larger than 2220 and for the higher ends of capacitance ranges due to possible thermal shock (capacitance values given upon request).

Infrared and vapor phase reflow, are preferred for high reliability applications as inherent thermo-mechanical strains are lower than those inherent to wave soldering.

Whatever the soldering process is, it is highly recommended to apply a thermal cycle, see hereafter our recommended soldering profile:

RECOMMENDED VAPOR PHASE REFLOW PROFILE

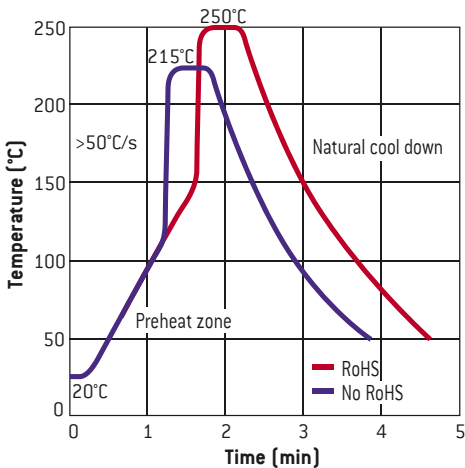

RECOMMENDED IR REFLOW PROFILE

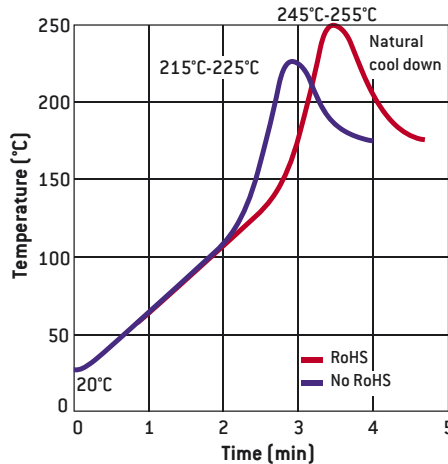

RECOMMENDED WAVE SOLDERING PROFILE

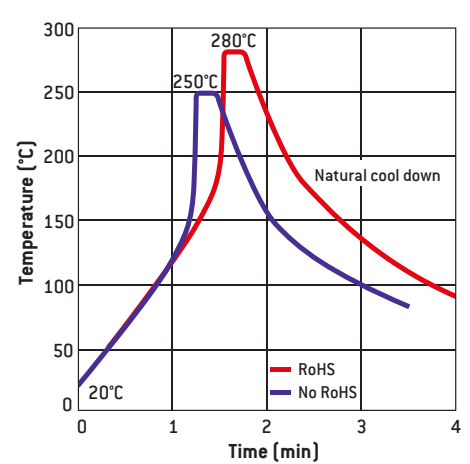

SOLDERING ADVICES FOR IRON SOLDERING

Attachment with a soldering iron is discouraged due to ceramic brittleness and the process control limitations. In the event that a soldering iron must be used, the following precautions should be observed:

- Use a substrate with chip footprints big enough to allow putting side by side one end of the capacitor and the iron tip without any contact between this tip and the component,
- place the capacitor on this footprint,

- heat the substrate until the capacitor's temperature reaches 150°C minimum (preheating step, maximum 1°C per second),
- place the hot iron tip (a flat tip is preferred) on the footprint **without touching the capacitor**. Use a regulated iron with a 30 watts maximum power. The recommended temperature of the iron is 270 ±10°C. The temperature gap between the capacitor and the iron tip must not exceed 120°C,

User Guide

- leave the tip on the footprint for a few seconds in order to increase locally the footprint's temperature,
- use a cored wire solder and put it down on the iron tip. In a preferred way use Sn/Pb/Ag 62/36/2 alloy,
- wait until the solder fillet is formed on the capacitor's termination,
- take away iron and wire solder,
- wait a few minutes so that the substrate and capacitor come back down to

the preheating temperature,

- solder the second termination using the same procedure as the first,
- let the soldered component cool down slowly to avoid any thermal shock.

PACKAGING

TAPE AND REEL

The films used on the reels correspond to standard IEC 60286-3. Films are delivered on reels in compliance with document IEC 286-3 dated 1991.

Minimum quantity is 250 chips.

Maximum quantities per reel are as follows:

- Super 8 reel - Ø 180: 2,500 chips.
- Super 8 reel - Ø 330: 10,000 chips.
- Super 12 reel - Ø 180: 1,000 chips.

Reel marking complies with CECC 32100 standard:

- Model.
- Rated capacitance.
- Capacitance tolerance.
- Rated voltage.
- Batch number.

TRAY PACKAGES

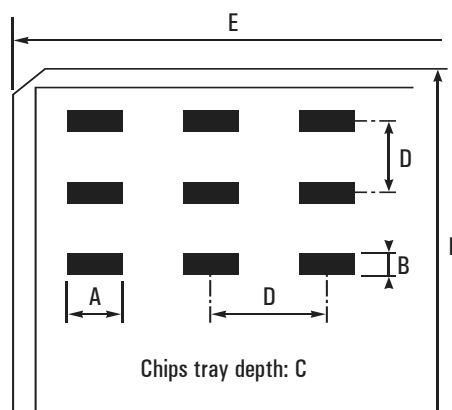

DIMENSIONAL CHARACTERISTICS OF CHIPS TRAY PACKAGES

Sizes	Nr. of chips/ package	Oriented chips	Dimensions in inches (in mm)				
			A	B	C	D	E
0402	100	No	0.0112 (0.302)		0.065 (1.65)	0.167 (4.24)	2 (50.8)
0403	100	No	0.0112 (0.302)		0.065 (1.65)	0.167 (4.24)	2 (50.8)
0504	100	Yes	0.059 (1.5)	0.045 (1.14)	0.035 (0.89)	0.167 (4.24)	2 (50.8)
0603	340	Yes	0.1 (2.54)	0.06 (1.52)	0.045 (1.14)	0.167 (4.24)	2 (50.8)
0805	100	Yes	0.1 (2.54)	0.06 (1.52)	0.045 (1.14)	0.167 (4.24)	2 (50.8)
1206	100	No	0.14 (3.56)	0.14 (3.56)	0.06 (1.52)	0.167 (4.24)	2 (50.8)
1210	100	Yes	0.14 (3.56)	0.14 (3.56)	0.06 (1.52)	0.167 (4.24)	2 (50.8)
1812	100	No	0.25 (6.35)	0.25 (6.35)	0.13 (3.3)	0.345 (8.76)	4 (101.6)
	25	Yes	0.24 (6.1)	0.265 (6.73)	0.07 (1.78)	0.345 (8.76)	2 (50.8)
2220	100	Yes	0.25 (6.35)	0.25 (6.35)	0.13 (3.3)	0.345 (8.76)	4 (101.6)
	25	Yes	0.24 (6.1)	0.265 (6.73)	0.07 (1.78)	0.345 (8.76)	2 (50.8)

HIGH Q CAPACITORS TAPE AND REEL PACKAGING SPECIFICATIONS

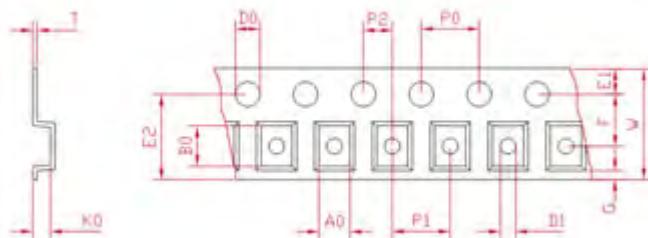

Sizes	Type (1)	W±0.3 inches (mm)	F±0.05 inches (mm)	P1±0.1 inches (mm)	T max. inches (mm)	Reel Size inches (mm)	Quantity per Reel
A (0505)	H	0,315 (8)	0,138 (3.5)	0,157 (4)	0,010 (0,25)	7,087 (180)	3'000
A (0505)	V	0,315 (8)	0,138 (3.5)	0,157 (4)	0,010 (0,25)	7,087 (180)	3'000
S (0603)	H	0,315 (8)	0,138 (3.5)	0,157 (4)	0,016 (0,4)	7,087 (180)	4'000
F (0805)	H	0,315 (8)	0,138 (3.5)	0,157 (4)	0,016 (0,4)	7,087 (180)	4'000
B (1111)	H	0,315 (8)	0,138 (3.5)	0,157 (4)	0,012 (0,3)	7,087 (180)	1'000
B (1111)	V	0,315 (8)	0,138 (3.5)	0,157 (4)	0,010 (0,25)	7,087 (180)	1'000
X (2225)	H	0,472 (12)	0,138 (5.5)	0,472 (12)	0,018 (0,45)	12,992 (330)	500
E (4040)	H	0,945 (24)	0,453±0,004 (11.5±0.1)	0,630 (16)	0,018 (0,45)	12,992 (330)	700
E (4040)	V	1,260 (32)	0,559±0,004 (14.2±0.1)	0,945 (24)	0,022 (0,55)	15 (381)	350

(1): Horizontal (H) or Vertical (V) orientation in cavities.

User Guide

EIA STANDARD CAPACITANCE VALUES

Following EIA standard, the values and multiples that are indicated in the chart below can be ordered. E48, E96 series and intermediary values are available upon request.

E6 (± 20%)	E12 (± 10%)	E24 (± 5%)
10	10	10 11 12
	12	13
	15	15 16 18
15	18	20
	22	22 24 27
	27	30
22	33	33 36 39
	39	43
	47	47 51 56
33	56	62
	68	68 75 82
	82	91

Voltage (V)	Code	Letter code
25	250	A
40	400	B
50	500	C
63	630	D
100	101	E
200	201	G
250	251	H
400	401	K
500	501	L
1,000	102	M
2,000	202	P
3,000	302	R
4,000	402	S
5,000	502	T
7,500	752	U
10,000	103	W

EIA CAPACITANCE CODE

The capacitance is expressed in three digit codes and in units of pico Farads (pF). The first and second digits are significant figures of the capacitance value and the third digit identifies the multiplier.

For capacitance value < 10pF, R designates a decimal point.
See examples below:

EIA code	Capacitance value		
	in pF	in nF	in μ F
2R2	2.2	0.0022	0.0000022
6R8	6.8	0.0068	0.0000068
220	22	0.022	0.000022
470	47	0.047	0.000047
181	180	0.18	0.00018
221	220	0.22	0.00022
102	1,000	1	0.001
272	2,700	2.7	0.0027
123	12,000	12	0.012
683	68,000	68	0.068
124	120,000	120	0.12
564	560,000	560	0.56
335	3,300,000	3,300	3.3
825	8,200,000	8,200	8.2
156	15,000,000	15,000	15
686	68,000,000	68,000	68
107	100,000,000	100,000	100
227	220,000,000	220,000	220

PART MARKING TOLERANCE CODES

Use the following tolerance code chart for part markings:

Tolerance	Letter code
±0.25pF	CU
±0.5pF	DU
±1pF	FU
±1%	F
±2%	G
±5%	J
±10%	K
±20%	M

PART MARKING VOLTAGE CODES

Use the following voltage code chart for part markings:

User Guide

RELIABILITY LEVELS

Exxelia proposes different reliability levels for the ceramic capacitors for both NPO and X7R ceramics.

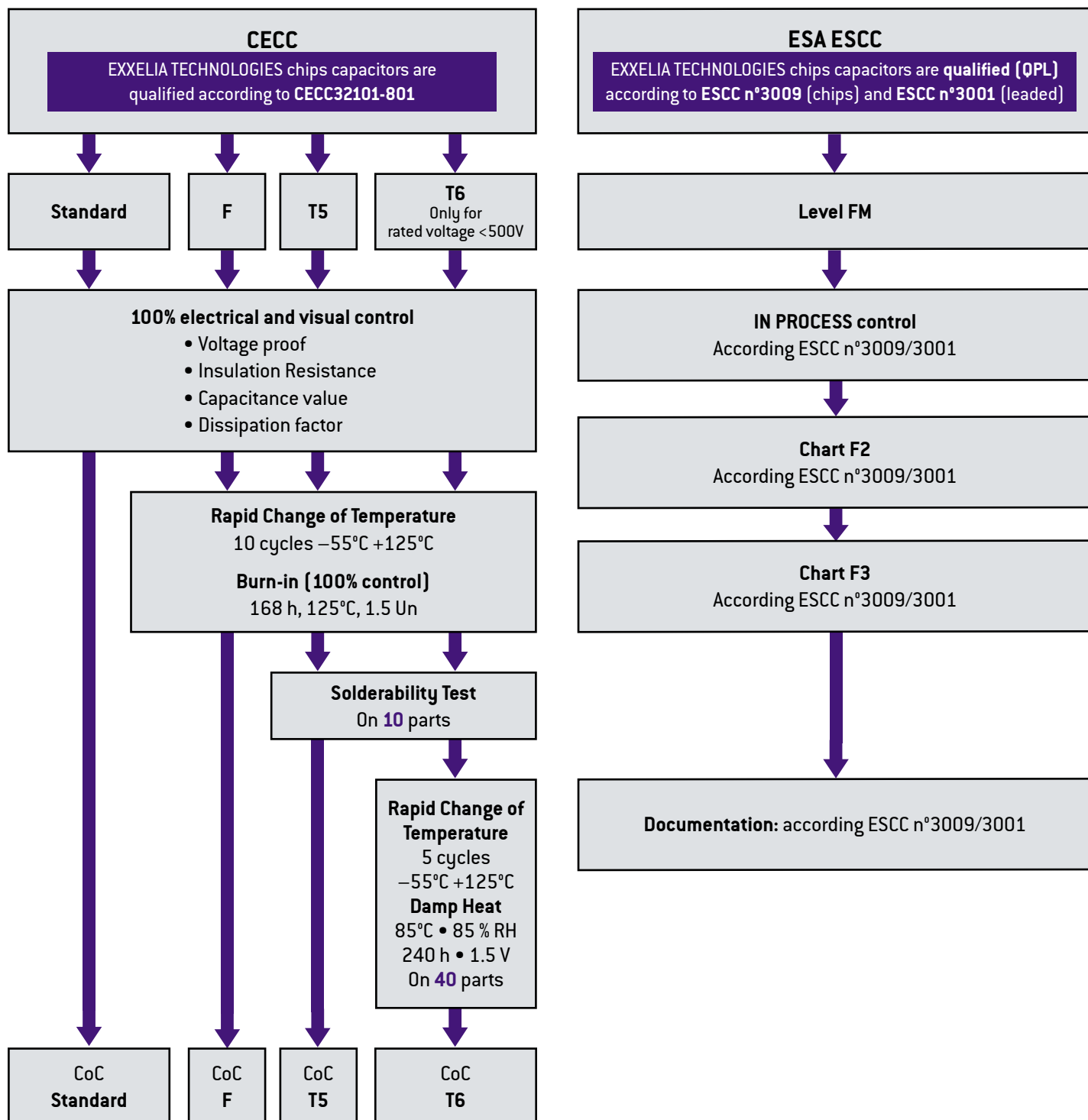

As the world's leading manufacturer of specific passive components, we stand apart through our ability to quickly evaluate the application specific engineering challenges and provide a cost-effective and efficient solutions.

For requirements that cannot be met by catalog products, we offer leading edge solutions in custom configuration: custom geometries, packaging, characteristics, all is possible thanks to our extensive experience and robust development process, while maintaining the highest level of reliability.

Where necessary, special testing is done to verify requirements, such as low dielectric absorption, ultra-high insulation resistance, low dissipation factor, stability under temperature cycling or under specified environmental conditions, etc.

HIGH CAPACITANCE

- High energy density
- Specific case sizes
- Specific shape of connections (high resistance to vibrations)

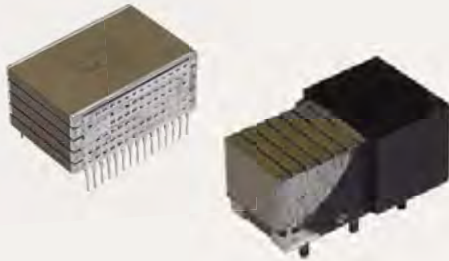

HIGH VOLTAGE

- Up to 50 kV
- Specific circular shape

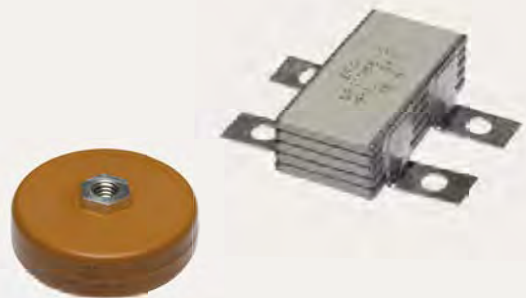

HIGH TEMPERATURE

- Up to 250°C
- Specific shape of connections
- 2,000 hours life time
- HMP soldering



OTHERS

- Screen printed resistors
- Complex components
- Full functions available

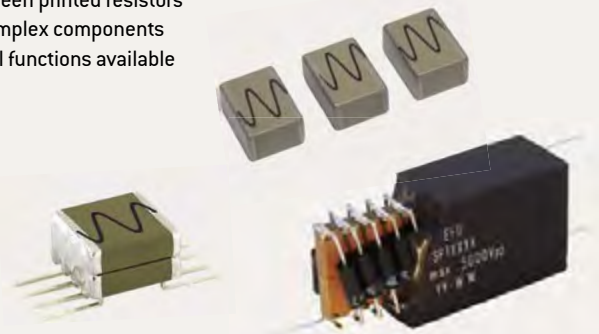

General Information

MATERIALS EXPERT

For 50 years and as a market leader, EXXELIA's comprehensive knowledge of the materials properties and performances have enabled us to design capacitors in Porcelain, NPO, BX, 2C1, BP, X7R and –2200ppm/°C ceramics.

CUSTOM DESIGNS

Our catalog products don't meet your application?

Based on the valuable experience accumulated over the design of 2,000+ specific ceramic capacitors, you can trust EXXELIA to define a qualitative custom solution in a time effective manner.

NO OBSOLESCENCE

Choosing a standard or custom EXXELIA product means you won't have to worry about obsolescence.

TYPICAL APPLICATIONS

- Aerospace & Defense: cockpit panels, flight control, radio systems, missile guidance systems...
- Space: military and commercial satellites, launcher...
- Medical: MRI, external defibrillators, implantable devices...
- Telecommunications: base stations...
- Oil and gas: drilling tools, MWD, LWD, wellheads...

ISO 9001 AND AS9100C

Quality is at the core of Exxelia's corporate culture. Each sites has its own certifications.

CERTIFICATIONS

Capacitors manufactured by EXXELIA comply with American and European standards and meet the requirements of many international standards. For Space qualified parts (ESA QPL), please refer to our catalog «Ceramic capacitors for Space applications».

QUALITY & RELIABILITY

EXXELIA is committed to design and manufacture high quality and reliability products. The test cycles reproducing the most adverse operating conditions over extended periods (up to 10 000 hours) have logged to date well over 5.10^9 hours/°C/component.

Failure rate data can be provided upon request.

CONFLICT MINERALS

EXXELIA is committed to an approach based on «Conflict Minerals Compliance». This US SEC rule demands complete traceability and a control mechanism for the mineral procurement chain, encouraging importers to buy only «certified» ore.

We have discontinued relations with suppliers that procure from the Democratic Republic of the Congo or an adjoining country.

ENVIRONMENT

EXXELIA is committed to applying a robust environmental policy, from product design through to shipment. To control its environmental footprint and reconcile this with the company's functional imperatives, our environmental policy provides for the reduction or elimination of hazardous substances. We also focus on compliance with European Union directives and regulations, notably REACH and RoHS.

RoHS COMPLIANCY

SMD CAPACITORS

The capacitor terminations are generally protected by a nickel barrier formed by electrolytic deposit. This barrier gives chip capacitors leaching performance far exceeding the requirements of all applicable standards. The nickel barrier guarantees a minimum resistance to soldering heat for a period of 1 minute at 260°C in a tin-lead (60/40) or tin-lead-silver (62/36/2) bath without noticeable alteration to the solderability. It also allows repeated soldering-unsoldering and the longer soldering times required by reflow techniques.

However nickel barrier amplifies thermal shock and is not recommended for chip sizes equal or greater than CNC Y (30 30) - [C 282 to C 288 - CNC 80 to CNC 94].

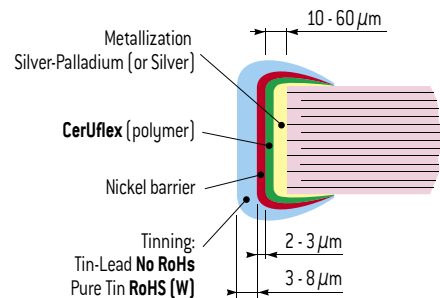

LEADED COMPONENTS

As well as for SMD products, leaded capacitors ranges can also be RoHS. These products, which are characterized by the suffix «W» added to the commercial type, are naturally compatible with the soldering alloys used in RoHS mounting technology. The connections coating is generally an alloy SnAg (with a maximum of 4% Ag). However, on a few products that EXXELIA will precise on request, the coating is pure silver.