

SICAL CO42 - SICAL

CO 42

10 000 h / 85°C

10 V ... 630 V	2,2 μ F ... 47 000 μ F	\emptyset 6,5 (0,256) ... \emptyset 25 (0,984)	- 55°C + 85°C	Long Life Time
----------------	--------------------------------	--	---------------	----------------

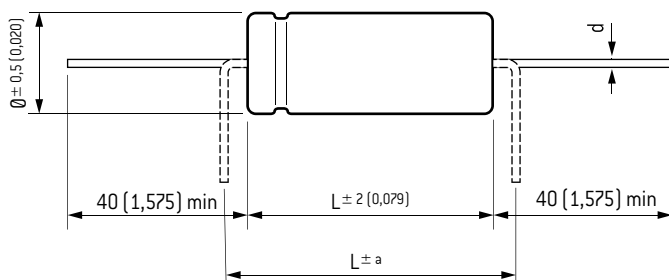
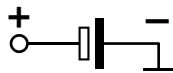

Dimensions in mm (inches)

DIMENSIONS in mm (inches)

\emptyset	d	a
6,5 - 21 (0,256 - 0,827)	0,8 (0,031)	4 (0,157)
25 (0,984)	1 (0,039)	8 (0,315)

SPECIFICATIONS

NFC 83 110 - Long life
 DIN 41 240 - Climatic category GPF - 55°C + 85°C / 56 days
 CECC 30 301-019 (SICAL CO 42)
 CECC 30 300 (SICAL)
 IEC 60 384.4 - Long life
 Standard endurance test U_R : 5000 h / 85°C

APPLICATIONS

- Coupling/decoupling
- Filtering
- Circuits with time constant
- Switch mode power supplies

Insulating aluminum case

Axial tin-coated copper leads

Welded chain providing perfect continuity of the circuit.

Tolerance on capacitance at 20°C:

- 10 + 50 % (SICAL CO 42)

- 20 + 20 % (SICAL)

Operating temperature: - 55°C + 85°C

RESISTANCE TO VIBRATIONS

	Standard	On request
f (Hz)	10 - 55 Hz	10 - 2000 Hz
Amplitude	0,75 (0,030)	1,5 (0,059)
Acceleration	10 g - 98 m/s ²	20 g - 196 m/s ²
t (h)	3 x 2 h	3 x 2 h

WITHSTAND STRENGTH OF INSULATING SLEEVE

Insulating resistance at 20°C between leads and mounting hardware: 100 M Ω

Test voltage at 50 Hz 1 min. between leads and mounting hardware: 1000 V

Fire resistance: self extinguish 30 s (IEC 60 695-2-2) without PVC

SICAL C042 - SICAL

C0 42

10 000 h / 85°C

Capacitance (μF)	Dimensions		Tan δ 100 Hz +20°C max. (%)	ESR 100 Hz Typic (Ω)	Z 10 kHz +20°C max. (Ω)	II +20°C 5 min. max. (μA)	I~ 100 Hz +85°C max. (A)	Code		
	\emptyset mm (inches)	L mm (inches)								
Rated voltage / Peak voltage: 10/12 V										
100	6,5	[0,256]	19	[0,748]	13	1,5	1,1	10	0,2	A 748201
220	8,5	[0,335]	19	[0,748]	15	0,75	0,5	17	0,33	A 748203
270	6,5	[0,256]	19	[0,748]	13	0,60	0,5	18	0,26	A 748208
330	10	[0,394]	19	[0,748]	17	0,45	0,4	24	0,48	A 748204
470	10	[0,394]	19	[0,748]	17	0,35	0,3	32	0,54	A 748205
510	8,5	[0,335]	19	[0,748]	15	0,36	0,4	31	0,39	A 748209
730	10	[0,394]	19	[0,748]	17	0,30	0,3	44	0,47	A 748210
1000	10	[0,394]	25	[0,984]	17	0,18	0,2	60	0,85	A 748207
2200	16	[0,630]	30	[1,181]	17	0,07	0,09	135	1,9	A 749000
3300	18	[0,709]	30	[1,181]	17	0,05	0,07	200	2,4	A 749001
4700	16	[0,630]	30	[1,181]	17	0,07	0,09	285	1,9	A 749003
4700	18	[0,709]	40	[1,575]	17	0,04	0,05	285	3,1	A 749002
6300	18	[0,709]	30	[1,181]	17	0,05	0,07	370	2,4	A 749004
9400	18	[0,709]	40	[1,575]	17	0,04	0,05	560	3,1	A 749005
4700	14	[0,551]	30	[1,181]	23	0,05	0,06	285	2,1	A 749500
6800	16	[0,630]	30	[1,181]	24	0,04	0,05	410	2,5	A 749502
10000	18	[0,709]	40	[1,575]	26	0,03	0,04	600	3,5	A 749501
Rated voltage / Peak voltage: 16/18 V										
47	6,5	[0,256]	19	[0,748]	9	1,5	1,1	8	0,2	A 748219
68	6,5	[0,256]	19	[0,748]	12	1,3	0,8	10	0,22	A 748222
100	6,5	[0,256]	19	[0,748]	12	1	0,75	14	0,25	A 748220
150	6,5	[0,256]	19	[0,748]	12	1,3	0,8	18	0,22	A 748229
150	8,5	[0,335]	19	[0,748]	12	0,8	0,7	18	0,32	A 748223
220	6,5	[0,256]	19	[0,748]	12	1	0,75	25	0,25	A 748230
220	8,5	[0,335]	19	[0,748]	14	0,55	0,6	25	0,39	A 748224
280	8,5	[0,335]	19	[0,748]	12	0,8	0,7	27	0,32	A 748231
330	10	[0,394]	19	[0,748]	15	0,5	0,5	35	0,45	A 748225
420	8,5	[0,335]	19	[0,748]	14	0,55	0,6	40	0,39	A 748232
470	10	[0,394]	19	[0,748]	15	0,4	0,45	49	0,5	A 748226
590	10	[0,394]	19	[0,748]	15	0,4	0,45	57	0,5	A 748233
680	10	[0,394]	25	[0,984]	15	0,17	0,22	65	0,87	A 748227
840	10	[0,394]	25	[0,984]	15	0,17	0,22	81	0,87	A 748234
1000	12	[0,472]	30	[1,181]	15	0,13	0,13	100	1,2	A 748228
1500	16	[0,630]	30	[1,181]	15	0,11	0,11	145	1,5	A 749021
1700	12	[0,472]	30	[1,181]	15	0,13	0,13	160	1,2	A 748235
2200	18	[0,709]	30	[1,181]	15	0,05	0,05	215	2,4	A 749022
3800	16	[0,630]	30	[1,181]	15	0,11	0,11	365	1,5	A 749024
4700	21	[0,827]	40	[1,575]	15	0,03	0,04	455	3,9	A 749023
5100	18	[0,709]	30	[1,181]	15	0,05	0,05	490	2,4	A 749025
7900	21	[0,827]	40	[1,575]	15	0,03	0,04	760	3,9	A 749026
2200	14	[0,551]	30	[1,181]	16	0,08	0,11	215	1,7	A 749508
3300	16	[0,630]	30	[1,181]	16	0,06	0,08	320	2,1	A 749509
4700	18	[0,709]	30	[1,181]	16	0,04	0,05	455	2,7	A 749510
10000	21	[0,827]	40	[1,575]	29	0,03	0,03	960	3,9	A 749511
22000	25	[0,984]	40	[1,575]	36	0,02	0,02	2100	5,2	A 749513
47000	25	[0,984]	75	[2,953]	50	0,013	0,015	4500	8,6	A 749514

SICAL C042 - SICAL

C0 42

10 000 h / 85°C

Capacitance (μ F)	Dimensions		Tan δ 100 Hz +20°C max. (%)	ESR 100 Hz Typic (Ω)	Z 10 kHz +20°C max. (Ω)	II +20°C 5 min. max. (μ A)	I~ 100 Hz +85°C max. (A)	Code		
	\varnothing mm (inches)	L mm (inches)								
Rated voltage / Peak voltage: 25/30 V										
22	6,5	(0,256)	19	(0,748)	8	2,2	1,6	6	0,15	A 748239
47	6,5	(0,256)	19	(0,748)	12	1,9	1,5	11	0,16	A 748242
100	8,5	(0,335)	19	(0,748)	12	1	0,9	19	0,29	A 748243
140	6,5	(0,256)	19	(0,748)	12	1,9	1,5	21	0,16	A 748249
150	8,5	(0,335)	19	(0,748)	12	0,8	0,7	27	0,32	A 748246
220	10	(0,394)	19	(0,748)	11	0,6	0,6	37	0,41	A 748244
270	8,5	(0,335)	19	(0,748)	12	0,8	0,7	41	0,32	A 748250
330	10	(0,394)	19	(0,748)	11	0,4	0,4	54	0,5	A 748247
380	10	(0,394)	19	(0,748)	11	0,4	0,4	57	0,5	A 748251
470	10	(0,394)	25	(0,984)	10	0,2	0,25	75	0,8	A 748245
540	10	(0,394)	25	(0,984)	10	0,2	0,25	81	0,8	A 748252
680	12	(0,472)	30	(1,181)	10	0,13	0,15	105	1,2	A 748248
1000	16	(0,630)	30	(1,181)	10	0,09	0,08	150	1,7	A 749041
1100	12	(0,472)	30	(1,181)	10	0,13	0,15	165	1,2	A 748253
1500	18	(0,709)	30	(1,181)	10	0,06	0,06	225	2,2	A 749042
2200	18	(0,709)	40	(1,575)	10	0,04	0,04	330	3,1	A 749043
2500	16	(0,630)	30	(1,181)	10	0,09	0,08	375	1,7	A 749044
3300	18	(0,709)	30	(1,181)	10	0,06	0,06	495	2,2	A 749045
4700	25	(0,984)	40	(1,575)	10	0,02	0,03	700	5,2	A 749047
5000	18	(0,709)	40	(1,575)	10	0,04	0,04	750	3,1	A 749046
5100	25	(0,984)	40	(1,575)	10	0,02	0,03	765	5,2	A 749048
1500	14	(0,551)	30	(1,181)	12	0,09	0,09	225	1,6	A 749520
2200	16	(0,630)	30	(1,181)	12	0,06	0,06	330	2,1	A 749521
3300	18	(0,709)	30	(1,181)	12	0,05	0,05	495	2,4	A 749522
4700	18	(0,709)	40	(1,575)	12	0,04	0,04	700	3,1	A 749523
6800	21	(0,827)	40	(1,575)	18	0,03	0,04	1020	3,9	A 749524
10000	25	(0,984)	40	(1,575)	21	0,02	0,03	1500	5,2	A 749515
15000	25	(0,984)	75	(2,953)	24	0,02	0,02	2250	6,9	A 749516
22000	25	(0,984)	75	(2,953)	36	0,02	0,02	3300	6,9	A 749517
Rated voltage / Peak voltage: 40/48 V										
33	6,5	(0,256)	19	(0,748)	10	2,2	2	11	0,17	A 748262
47	8,5	(0,335)	19	(0,748)	9	2	1,6	15	0,2	A 748263
63	6,5	(0,256)	19	(0,748)	10	2,2	2	15	0,17	A 748269
68	8,5	(0,335)	19	(0,748)	10	1,5	1,2	20	0,24	A 748261
100	10	(0,394)	19	(0,748)	10	0,85	0,8	28	0,35	A 748264
120	8,5	(0,335)	19	(0,748)	10	1,5	1,2	29	0,24	A 748270
170	10	(0,394)	19	(0,748)	10	0,85	0,8	41	0,35	A 748271
220	10	(0,394)	25	(0,984)	9	0,35	0,3	55	0,61	A 748266
330	10	(0,394)	25	(0,984)	10	0,27	0,25	83	0,69	A 748267
470	12	(0,472)	30	(1,181)	10	0,2	0,15	115	0,96	A 748268
680	16	(0,630)	30	(1,181)	8	0,08	0,07	165	1,8	A 749061
1000	18	(0,709)	30	(1,181)	9	0,07	0,07	240	2	A 749062
1100	16	(0,630)	30	(1,181)	8	0,08	0,07	264	1,8	A 749064
1500	18	(0,709)	30	(1,181)	9	0,07	0,07	360	2	A 749065
2200	21	(0,827)	40	(1,575)	10	0,04	0,04	530	3,4	A 749063
2900	21	(0,827)	40	(1,575)	10	0,04	0,04	700	3,4	A 749066
1000	14	(0,551)	30	(1,181)	10	0,08	0,08	240	1,7	A 749530
1500	16	(0,630)	30	(1,181)	10	0,08	0,08	360	1,8	A 749533
2200	18	(0,709)	40	(1,575)	10	0,04	0,04	530	3,1	A 749531
3300	18	(0,709)	40	(1,575)	12	0,03	0,03	800	3,5	A 749534
4700	21	(0,827)	40	(1,575)	13	0,025	0,03	1130	4,2	A 749532
10000	25	(0,984)	50	(1,969)	16	0,02	0,02	2400	5,8	A 749535
15000	25	(0,984)	75	(2,953)	23	0,02	0,02	3600	6,9	A 749537

SICAL C042 - SICAL

C0 42

10 000 h / 85°C

Capacitance (μF)	Dimensions		Tan δ 100 Hz +20°C max. (%)	ESR 100 Hz Typic (Ω)	Z 10 kHz +20°C max. (Ω)	II +20°C 5 min. max. (μA)	I~ 100 Hz +85°C max. (A)	Code		
	\emptyset mm (inches)	L mm (inches)								
Rated voltage / Peak voltage: 63/75 V										
10	6,5	[0,256]	19	[0,748]	8	4,1	4	6	0,12	A 748279
15	6,5	[0,256]	19	[0,748]	8	3,8	3,2	10	0,13	A 748286
22	8,5	[0,335]	19	[0,748]	7	2,8	2	12	0,17	A 748287
26	6,5	[0,256]	19	[0,748]	8	4,1	4	6	0,12	A 748280
33	8,5	[0,335]	19	[0,748]	8	2	1,3	16	0,2	A 748288
39	6,5	[0,256]	19	[0,748]	8	3,8	3,2	10	0,13	A 748281
47	8,5	[0,335]	19	[0,748]	7	2,8	2	22	0,17	A 748282
47	10	[0,394]	19	[0,748]	8	1,4	1,1	22	0,27	A 748289
68	10	[0,394]	19	[0,748]	8	1,2	0,9	30	0,29	A 748290
73	8,5	[0,335]	19	[0,748]	8	2	1,3	16	0,2	A 748283
100	10	[0,394]	19	[0,748]	8	1,2	0,9	40	0,29	A 748284
100	10	[0,394]	25	[0,984]	8	0,8	0,6	40	0,4	SICAL C042 A 748291
150	10	[0,394]	25	[0,984]	8	0,8	0,6	50	0,4	A 748285
150	12	[0,472]	30	[1,181]	8	0,4	0,35	50	0,68	A 749084
220	12	[0,472]	30	[1,181]	10	0,4	0,35	85	0,68	A 748293
290	12	[0,472]	30	[1,181]	10	0,4	0,35	85	0,68	A 748294
330	16	[0,630]	30	[1,181]	8	0,17	0,15	125	1,2	A 749081
470	18	[0,709]	30	[1,181]	8	0,11	0,1	180	1,6	A 749082
660	16	[0,630]	30	[1,181]	8	0,17	0,15	125	1,2	A 748290
1000	21	[0,827]	40	[1,575]	6	0,06	0,07	380	2,7	A 749083
2100	21	[0,827]	40	[1,575]	6	0,06	0,07	380	2,7	A 748292
2200	25	[0,984]	50	[1,969]	8	0,04	0,04	835	4,1	A 749086
4700	25	[0,984]	75	[2,953]	12	0,025	0,03	1780	5,6	A 749087
6700	25	[0,984]	75	[2,953]	12	0,025	0,03	1780	5,6	A 748294
680	14	[0,551]	30	[1,181]	8	0,14	0,12	260	1,3	A 749544
1000	16	[0,630]	30	[1,181]	9	0,12	0,11	380	1,5	A 749540
1500	18	[0,709]	40	[1,575]	9	0,09	0,08	570	2	A 749541
2200	21	[0,827]	40	[1,575]	9	0,05	0,04	835	3	SICAL A 749545
3300	25	[0,984]	40	[1,575]	11	0,04	0,03	1250	3,7	A 749546
4700	25	[0,984]	50	[1,969]	12	0,03	0,03	1780	4,7	A 749543
6800	25	[0,984]	75	[2,953]	12	0,02	0,02	2570	6,9	A 749547
Rated voltage / Peak voltage: 100/115 V										
4,7	6,5	[0,256]	19	[0,748]	7	9,4	5	5	0,08	A 748299
6,8	6,5	[0,256]	19	[0,748]	7	7,8	4,3	8	0,09	A 748301
10	6,5	[0,256]	19	[0,748]	7	6	3,8	10	0,1	A 748302
15	6,5	[0,256]	19	[0,748]	7	4,2	3,1	13	0,12	A 748303
22	8,5	[0,335]	19	[0,748]	7	2,6	2	17	0,18	A 748304
33	10	[0,394]	19	[0,748]	7	1,8	1,3	24	0,24	A 748307
47	10	[0,394]	25	[0,984]	7	1,2	0,7	32	0,33	SICAL C042 A 748306
68	12	[0,472]	30	[1,181]	7	0,8	0,6	45	0,48	A 748309
100	14	[0,551]	30	[1,181]	5	0,35	0,3	60	0,74	A 749100
150	14	[0,551]	30	[1,181]	7	0,3	0,25	94	0,86	A 749105
220	18	[0,709]	30	[1,181]	5	0,18	0,16	135	1,3	A 749101
470	21	[0,827]	40	[1,575]	7	0,1	0,1	285	2,1	A 749102
1000	25	[0,984]	50	[1,969]	7	0,05	0,04	600	3,6	A 749104
220	14	[0,551]	30	[1,181]	6	0,3	0,25	135	0,86	A 749550
330	16	[0,630]	30	[1,181]	7	0,25	0,2	200	1	A 749554
470	18	[0,709]	30	[1,181]	7	0,12	0,11	285	1,6	A 749551
680	21	[0,827]	40	[1,575]	8	0,1	0,1	400	2,1	A 749555
1000	21	[0,827]	40	[1,575]	8	0,07	0,07	600	2,5	SICAL A 749552
1500	25	[0,984]	50	[1,969]	8	0,06	0,06	900	3,3	A 749557
1800	25	[0,984]	50	[1,969]	8	0,05	0,05	1080	3,6	A 749558
2200	25	[0,984]	75	[2,953]	8	0,035	0,035	1320	5,2	A 749559
3300	25	[0,984]	75	[2,953]	8	0,03	0,03	1980	5,6	A 749556

SICAL C042 - SICAL

C0 42

10 000 h / 85°C

Capacitance (μF)	Dimensions		Tan δ 100 Hz +20°C max. (%)	ESR 100 Hz Typic (Ω)	Z 10 kHz +20°C max. (Ω)	II +20°C 5 min. max. (μA)	I \sim 100 Hz +85°C max. (A)	Code		
	\varnothing mm (inches)	L mm (inches)								
Rated voltage / Peak voltage: 160/180 V										
2,2	6,5	[0,256]	19	[0,748]	7	26	27	5	0,05	A 748320
4,1	6,5	[0,256]	19	[0,748]	7	26	27	8	0,05	A 748325
4,7	8,5	[0,335]	19	[0,748]	7	12	13	8	0,08	A 748321
8,1	8,5	[0,335]	19	[0,748]	7	12	13	8	0,08	A 748326
10	10	[0,394]	19	[0,748]	8	9	8	14	0,11	A 748322
22	12	[0,472]	25	[0,984]	7	2,1	2,1	25	0,28	A 748323
33	12	[0,472]	30	[1,181]	7	1,8	1,8	35	0,32	A 748324
47	16	[0,630]	30	[1,181]	7	1,4	1,3	49	0,43	A 749121
75	16	[0,630]	30	[1,181]	7	1,4	1,3	72	0,43	A 749125
100	18	[0,709]	40	[1,575]	7	0,45	0,6	100	0,92	A 749122
150	18	[0,709]	40	[1,575]	7	0,45	0,6	140	0,92	A 749126
220	25	[0,984]	40	[1,575]	7	0,25	0,3	215	1,5	A 749124
350	25	[0,984]	40	[1,575]	7	0,25	0,3	340	1,5	A 749127
47	14	[0,551]	30	[1,181]	10	1,3	1,2	49	0,41	A 749563
100	18	[0,709]	40	[1,575]	10	0,7	0,7	100	0,61	A 749560
150	18	[0,709]	30	[1,181]	10	0,6	0,6	148	0,7	A 749568
220	18	[0,709]	40	[1,575]	10	0,5	0,5	215	0,87	A 749561
330	21	[0,827]	40	[1,575]	10	0,3	0,3	321	1,2	A 749564
470	25	[0,984]	40	[1,575]	8	0,2	0,2	450	1,7	A 749565
1000	25	[0,984]	75	[2,953]	8	0,1	0,1	960	3,1	A 749567
Rated voltage / Peak voltage: 250/275 V										
10	10	[0,394]	19	[0,748]	8	11	10	19	0,1	A 748342
15	10	[0,394]	25	[0,984]	10	8,5	8,5	27	0,12	A 748343
22	14	[0,551]	30	[1,181]	6	2,5	2,3	37	0,3	A 749140
33	16	[0,630]	30	[1,181]	6	1,7	1,6	54	0,39	A 749141
47	18	[0,709]	30	[1,181]	6	1,1	1,1	74	0,52	A 749142
100	21	[0,827]	40	[1,575]	6	0,5	0,5	154	0,95	A 749143
22	12	[0,472]	25	[0,984]	7	3,4	3,8	37	0,22	A 748344
33	12	[0,472]	30	[1,181]	7	2	2,2	54	0,3	A 748345
47	14	[0,551]	30	[1,181]	7	1,5	1,5	74	0,38	A 749570
68	16	[0,630]	30	[1,181]	7	1,1	1,1	106	0,48	A 749573
100	18	[0,709]	30	[1,181]	7	0,7	0,7	154	0,64	A 749571
150	18	[0,709]	40	[1,575]	7	0,7	0,7	229	0,73	A 749574
220	21	[0,827]	40	[1,575]	7	0,5	0,50	334	0,95	A 749572
330	25	[0,984]	40	[1,575]	7	0,5	0,5	499	1	A 749575
470	25	[0,984]	75	[2,953]	7	0,1	0,1	709	3,1	A 749576
680	25	[0,984]	75	[2,953]	7	0,08	0,08	1020	3,50	A 749577
1000	25	[0,984]	75	[2,953]	7	0,07	0,07	1500	3,7	A 749578
Rated voltage / Peak voltage: 350/385 V										
6,8	10	[0,394]	19	[0,748]	7	10	10	18	0,1	A 748362
10	10	[0,394]	25	[0,984]	7	6	6	25	0,15	A 748363
15	14	[0,551]	30	[1,181]	6	3,2	3,2	36	0,26	A 749160
22	16	[0,630]	30	[1,181]	6	2,3	2,3	50	0,33	A 749161
33	18	[0,709]	30	[1,181]	6	1,2	1,2	73	0,49	A 749162
47	18	[0,709]	40	[1,575]	6	0,9	0,8	103	0,64	A 749163
15	12	[0,472]	25	[0,984]	6	3,8	3,8	36	0,2	A 748364
22	12	[0,472]	30	[1,181]	6	2,7	2,8	50	0,26	A 748365
33	14	[0,551]	30	[1,181]	6	2	2	73	0,33	A 749580
47	16	[0,630]	30	[1,181]	6	1,2	1,2	103	0,46	A 749581
100	21	[0,827]	40	[1,575]	6	0,5	0,5	214	0,94	A 749582
220	25	[0,984]	40	[1,575]	9	0,4	0,4	466	1,2	A 749585
470	25	[0,984]	75	[2,953]	9	0,3	0,3	991	1,8	A 749586

SICAL C042 - SICAL

C0 42

10 000 h / 85°C

Capacitance (μF)	Dimensions		Tan δ 100 Hz +20°C max. (%)	ESR 100 Hz Typic (Ω)	Z 10 kHz +20°C max. (Ω)	II +20°C 5 min. max. (μA)	I \sim 100 Hz +85°C max. (A)	Code		
	\emptyset mm (inches)	L mm (inches)								
Rated voltage / Peak voltage: 385/420 V										
6,8	10	[0,394]	19	[0,748]	10	20	22	20	0,07	A 748382
10	10	[0,394]	25	[0,984]	10	10,5	13	27	0,11	A 748383
15	12	[0,472]	25	[0,984]	10	4,5	5,5	39	0,19	A 748384
22	14	[0,551]	30	[1,181]	10	3,5	3,5	55	0,25	A 749590
33	16	[0,630]	30	[1,181]	10	1,9	1,9	80	0,37	A 749591
47	18	[0,709]	30	[1,181]	10	1,7	2	113	0,42	A 749592
100	21	[0,827]	40	[1,575]	10	0,8	1,1	235	0,75	A 749593
150	25	[0,984]	40	[1,575]	10	0,7	0,9	351	0,88	A 749597
220	25	[0,984]	50	[1,969]	10	0,5	0,9	512	1,2	A 749598
330	25	[0,984]	75	[2,953]	10	0,4	0,8	766	1,5	A 749599
Rated voltage / Peak voltage: 450/500 V										
6,8	10	[0,394]	19	[0,748]	13	24	26	330	0,07	A 748402
10	10	[0,472]	25	[0,984]	8	4,7	5,7	400	0,18	A 748403
10	14	[0,551]	30	[1,181]	8	5,5	4,5	400	0,2	A 749606
15	12	[0,472]	30	[1,181]	8	4	5	490	0,22	A 748405
15	14	[0,551]	30	[1,181]	8	4	3,5	490	0,24	A 749607
22	14	[0,551]	30	[1,181]	8	3,5	3,5	600	0,25	A 749600
33	16	[0,630]	30	[1,181]	9	3	3	730	0,29	A 749601
47	18	[0,709]	30	[1,181]	8	1,8	1,8	870	0,4	A 749602
100	21	[0,827]	40	[1,575]	9	0,9	0,9	1300	0,71	A 749603
150	25	[0,984]	40	[1,575]	10	0,7	0,7	1600	0,88	A 749608
220	25	[0,984]	50	[1,969]	10	0,5	0,5	1900	1,2	A 749609
330	25	[0,984]	75	[2,953]	10	0,4	0,4	2350	1,5	A 749610
Rated voltage / Peak voltage: 550/605 V										
15	18	[0,709]	40	[1,575]	7	3,5	3,5	540	0,33	A 749620
22	21	[0,827]	40	[1,575]	7	2,3	2,3	660	0,44	A 749621
33	25	[0,984]	40	[1,575]	7	1,5	1,5	810	0,6	A 749623
Rated voltage / Peak voltage: 630/695 V										
15	18	[0,591]	40	[1,575]	20	11	9	780	0,19	A 749640
22	21	[0,866]	40	[1,575]	20	7,5	5,8	940	0,24	A 749641
33	25	[1,299]	40	[1,575]	20	5,1	5,3	1150	0,33	A 749643

EXPECTED LIFE

As a function of temperature and ripple current
For $\emptyset = 6,5$ mm half life time values are applicable.

PERMISSIBLE RIPPLE CURRENT I (R.M.S. VALUE)

versus frequency f:

I \sim : permissible r.m.s. current at 100 Hz

f (Hz)	50	100	300	600	1 000	10 000	$\geq 50 000$
I	0,8 x I \sim	I \sim	1,2 x I \sim	1,3 x I \sim	1,35 x I \sim	1,5 x I \sim	1,6 x I \sim

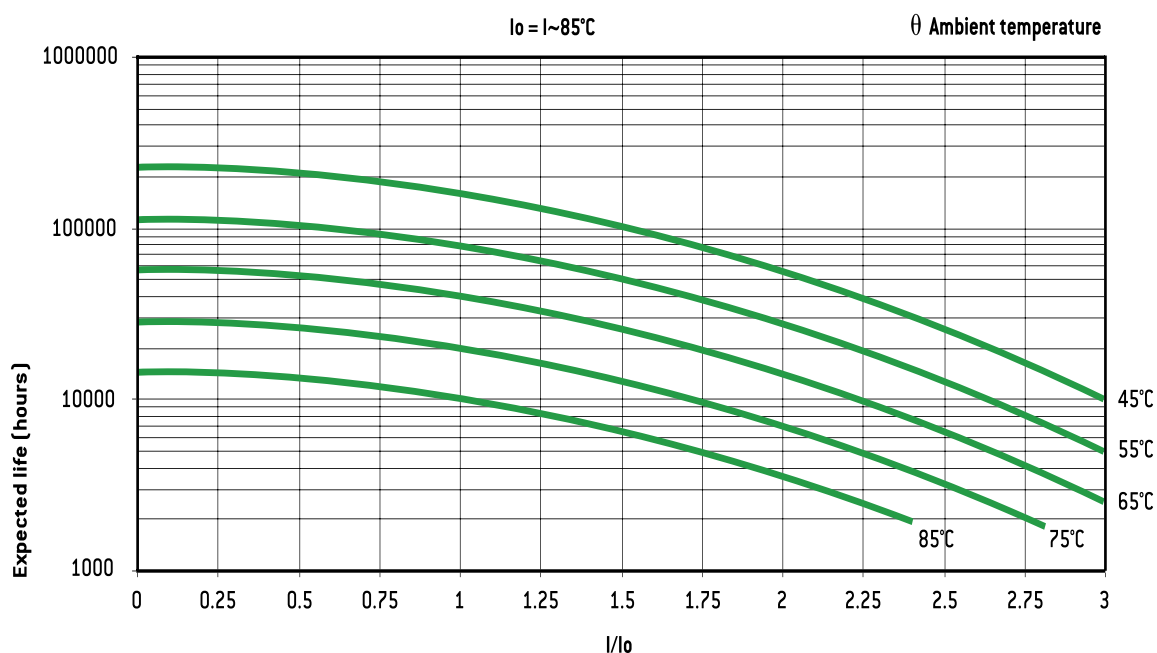

General technical data

1. BASIC CONSTRUCTION

Structure of an electrolytic aluminum capacitor is shown hereunder:

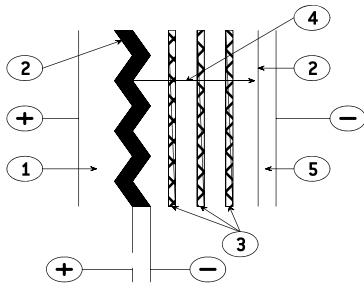

1. Anode: aluminum foil
2. Dielectric: aluminum oxide
3. Papers spacers impregnated with electrolyte
4. Ionic conduction assumed by electrolyte
5. Cathode: aluminum foil

The positive plate is an etched aluminum foil covered with alumina which is the dielectric of the capacitor.

The negative plate is constituted by a second aluminum foil which serves as a current supply, and by electrolyte-impregnated papers layers.

The metal used for anode is a $\geq 99,98$ % grade aluminum.

The dielectric has a thickness of $13 \text{ \AA} / \text{V}$.

The aluminum used for the cathode is a ≥ 98 % grade aluminum covered with a dielectric layer with a thickness of about 40 \AA .

2. DIAGRAM OF THE EQUIVALENT CIRCUIT

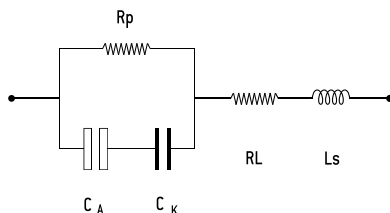

- CA = Capacitance of the anode
- CK = Capacitance of the cathode
- Rp = Parallel resistance due to the aluminum oxide film.
- RL = Series resistance of connections, plates and impregnated spacer.
- Ls = Inductance of winding and connections.

A standard simplified diagram is.

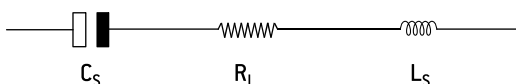

Cs is the series capacitance of both anode and cathode capacitances. Electrolytic aluminum capacitors are naturally polarized because of the insulating film on the anode. Given the very thin aluminum oxide layer, a reversed voltage should not exceed 1.5 V when there is energy supply.

Short duration reverse voltages can be absorbed by special construction, second anode replacing the former cathode.

3. CAPACITORS MARKING

3.1. ARTICLE CODE (ON EACH PACKAGING)

A followed by 6 figures number. First 3 positions are specific of the range. (Ex. A 745xxx for a FELSIC 85 BD)

140 FELSIC in bank	741 FELSIC 125 FRS BD (ex 731)
701 PRORELSIC 125	742 PRORELSIC 105 TFRS
703 PRORELSIC 125	743 PRORELSIC 105 TFRS
704 SNAPSIC	744 FELSIC 85 BC
705 SNAPSIC 105	FELSIC 85 LP
706 FELSIC HP BC – BD	745 FELSIC 85 BD
708 PRORELSIC 145	746 FELSIC 85 M BC
710 CUBISIC	747 FELSIC 85 M BD
711 PROMISIC 031	748 SICAL CO 42 - SICAL
712 CUBISIC LP	749 SICAL CO 42 - SICAL
713 SNAPSIC 105 LP	750 CUBISIC 125
714 SNAPSIC 4P	756 FELSIC 105 BC
715 SNAPSIC 105 4P	FELSIC 105 LP
716 SNAPSIC HV	757 FELSIC 105 BD
717 SNAPSIC HC	760 FELSIC HC BC
718 SNAPSIC 125	761 FELSIC HC BD
721 RELSIC 033	762 FELSIC 105 TFRS BC
722 CI FRS	763 FELSIC 105 TFRS BD
723 CI FRS	764 FELSIC HV BC
728 FELSIC 039 (ex 727)	765 FELSIC HV BD
FELSIC DI	775 VACSIC
738 FELSIC 037 (ex 737)	774 VACSIC 150
740 FELSIC 125 FRS BC (ex 731)	776 ALSIC 20G
	ALSIC 145 20G

In FELSIC ranges, article code without first letter A, is printed on each capacitor.

a Figure 9 in fourth position shows a special product.

3.2. BATCH (ON EACH CAPACITOR).

3 figures or 6 figures

3.3. DATE (ON EACH CAPACITOR IF APPLICABLE)

4 figures (year-week)

4. ELECTRICAL CHARACTERISTICS

4.1. RATED CAPACITANCE C_R

The rated capacitance is defined at 100 Hz and at ambient temperature.

4.2. RATED VOLTAGE U_R

U_R is the maximum DC voltage which may be applied in continuous operation.

When applying a superimposed alternating voltage, the peak value of the resulting waveform should not exceed the rated voltage.

4.3. PEAK VOLTAGE U_p

U_p is the maximum repetitive voltage which can be applied within short periods.

Defined in CECC 30 300 and IEC 60 384-4:

1000 cycles of 30 s charge followed by a no load period of 5 min. 30 s with upper category temperature.

$$U_p \leq 1,15 U_R (U_R \leq 315 \text{ V})$$

$$U_p \leq 1,10 U_R (U_R > 315 \text{ V})$$

General technical data

4.4. DISSIPATION FACTOR $\tan\delta$

The dissipation or loss factor is defined by its tangent $\tan\delta$

$$\tan\delta = R_s C_s \omega$$

$$(\omega = 2\pi F)$$

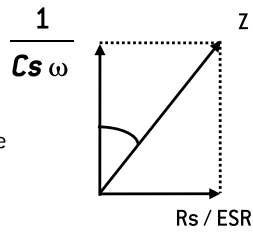

ESR Capacitor Equivalent Series Resistance

Cs Capacitor capacitance

F Frequency (100 Hz)

Z Capacitor impedance

4.5. EQUIVALENT SERIES RESISTANCE ESR

The relation between ESR and dissipation factor $\tan\delta$ is given in § 4.4.

4.6. IMPEDANCE Z - INDUCTANCE L

The impedance is given by:

$$Z = \sqrt{R^2 + \left[L\omega - \frac{1}{C\omega}\right]^2}$$

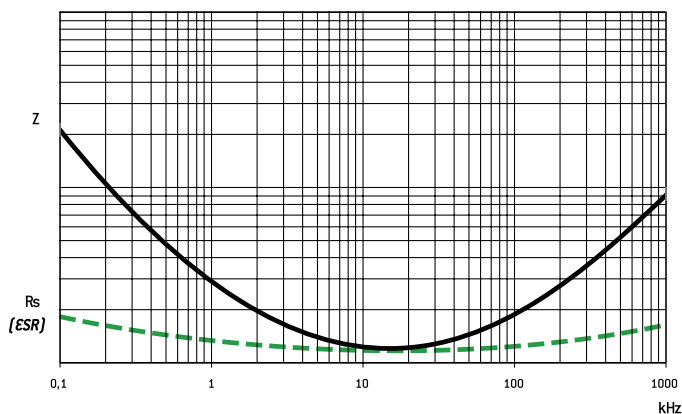

L inductance. Generally L = 5 to 20 nH

Z and ESR as function of frequency typically follows the chart:

4.7. PERMISSIBLE RIPPLE CURRENT (I r.m.s.) I_r

The current is defined at the maximum climatic category and at 100 Hz. It is the root mean square value r.m.s. The value I_0 is the rated value for calculations of expected life up to 3 I_0 .

4.8. LEAKAGE CURRENT II

I_l is measured at 20°C after a 5 min. polarization under rated voltage.

For C_R in μF and U_R in V:

$I_l \leq 0,01 C_R U_R$ or $1 \mu A^*$

when $C_R U_R \leq 1000 \mu C$

$I_l \leq 0,006 C_R U_R + 4 \mu A$

when $C_R U_R > 1000 \mu C$

For $U_R > 350 V_{DC}$ it can be specified:

with $K = 4, 6$ or 8

or

$I_l \leq 0,3 (C_R U_R)^{0,7} + 4 \mu A$ (CECC 30 300)

* Whichever is the greater

4.9. CHARACTERISTICS

Versus temperature (typical values).

4.9.1. Capacitance drift

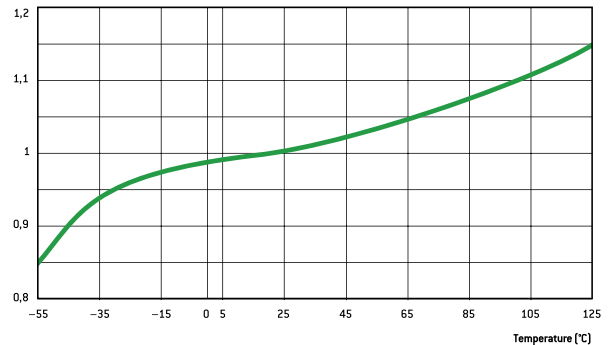

Versus temperature

4.9.2. ESR and Z drifts at 100 Hz

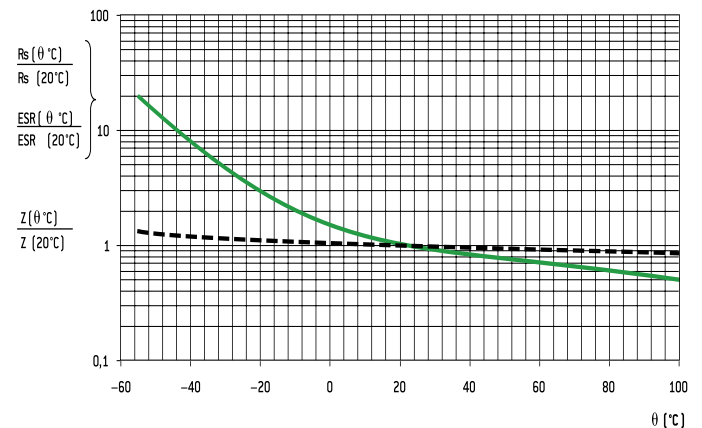

Versus temperature

4.9.3 Leakage current drift

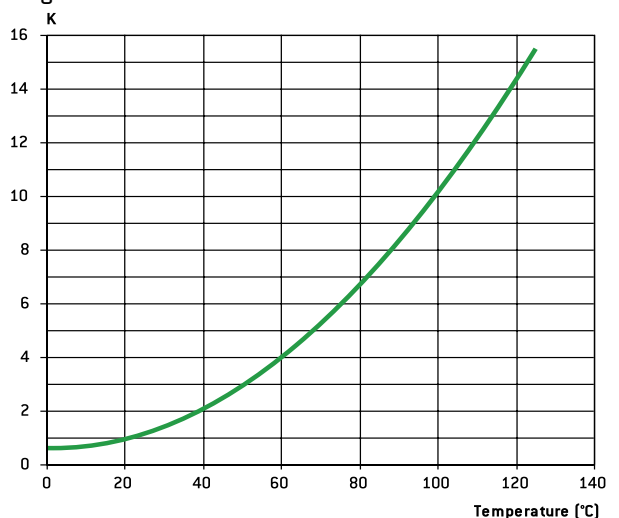

Versus temperature

General technical data

5. SPECIFICATION TO APPLY

Electrolytic aluminum capacitors are defined in:

- NF and UTE French national standard
- CECC European specifications
- IEC international specifications

Quality insurance procedures are described in these specifications.

	French	European	International
Generic specification Fixed capacitors	NF C 83 100	CECC 30 000 EN 130 000	IEC 60 384 -1 QC 300 000
Sectional specification Electrolytic aluminum capacitors	NF C 83 110	CECC 30 300	IEC 60 384 - 4 C 300 300
Blank deta II specification - Electrolytic aluminum capacitors with non solid electrolyte.	UTE 83 110	CECC 30 301	IEC 60 384 - 4 -1 QC 300 301
Blank deta II specifications	CECC 30 301- 017 to CECC 30 301- 062 C0 31 to C0 55	CECC 30 301- 017 to CECC 30 301- 062 CECC 30 301- 802 to CECC 30 301- 811	

6. ENDURANCE TESTS / LIFE TIME

6.1. STANDARD ENDURANCE TEST

at max category temperature:

Standard endurance tests do not exceed 2000 hours at 125°C. However,

Temperature	Endurance test			
	Grade I - Long life			Grade II - General purpose
	10 000 h	5 000 h	2 000 h	1 000 h
125°C			•	
105°C		•	•	•
85°C	•	•	•	•

present EXXELIA technologies concerning liquid electrolytes have led to endurance tests up to 5000 hours at 125°C (PRORELSIC 125 - FELSIC 125 RS) and even 20000 hours at 125°C (PRORELSIC 145 - ALSIC 145)

6.2. PERFORMANCE REQUIREMENTS ON STANDARD ENDURANCE TESTS.

Permissible capacitance drift $\Delta C/C$ (%)

Permissible increase factors on $\tan\delta$, ESR, Z and II initial values

(1) $\tan\delta$ or ESR: for initial value, take standard value.

U_R	Endurance test			
	Grade I			Grade II
	10 000 h	5 000 h	2 000 h	1 000 h
6,3 V			+15 -30	+25 -40
10 V - 35 V	+15 -20	±15	±15	±30
40 V - 160 V	±15	±15	±15	±30
> 160 V	±15	±10	±10	±15

	Endurance test			
	Grade I			Grade II
	10 000 h	5 000 h	2 000 h	1 000 h
$\tan\delta$ or ESR [1]	1,5	1,3	1,3	1,5
Z [2]	3	2	2	3
II	Standard values			

[2] Z: for initial value, take specified value [see data sheet].

Specific requirements can be taken into consideration with regards to initial values of dissipation factor or equivalent series resistance and impedance.

6.3. FAILURE CRITERIA FOR ELECTROLYTIC CAPACITORS.

Failure criteria are defined in CECC 30 301

- Non measurable defaults leading to complete failure.
- Measurable defaults leading to adjustment losses of the load circuit (failure due to variations).

6.3.1. Non measurable defaults.

They might be summed up as:

- Open circuit
- Short circuit
- Operation of pressure relief device
- Severely damaged insulation
- Unusable terminations

6.3.2. Measurable defaults.

Variations exceeding the values given below characterize a default.

- Capacitance drift $\Delta C/C$ (%): 3 times the limit for standard endurance testing or 50 % (whichever is the smallest).
- $\tan\delta$ or ESR: 3 times standard max initial values.
- Z: 3 times standard max initial values.
- II: initial limit (under load conditions).

Specific requirements can be taken into consideration with regards to lower drifts.

6.4. INFLUENCE OF MAIN PARAMETER ON OPERATIONAL LIFE.

6.4.1. Temperature.

The capacitors operational life is highly dependent upon its internal temperature Θ_i and therefore upon the ambient temperature and the ripple current.

Knowing ESR and dissipated power values (§ 6.4.3.) one can figure out, the internal temperature rise and then determine the capacitors expected life.

With present high boiling point electrolytes (§ 8.6)

$\Theta_i \text{ max} = 125 \text{ to } 185^\circ\text{C}$ depending on styles.

6.4.2. Ripple current.

The ripple current flowing through the capacitor increase the internal temperature through power dissipation.

Standards define the permissible current at 100 Hz and generally consider a temperature rise of 5 to 10°C of max category temperature.

Current waveforms and frequencies make it difficult to clearly determine the capacitors internal temperature rise, which defines the operationally life.

Experiments confirm following relationship:

$$\Theta_i = \Theta_a + (\Theta_c - \Theta_a) K$$

Where:

- Θ_i = Internal hot spot temperature
- Θ_a = Ambient temperature
- Θ_c = Case temperature
- K = Parameter depending upon case diameter and cooling
 - $\emptyset \geq 51 \text{ k} = 2 \pm 0,5$
 - $\emptyset < 51 \text{ k} = 1,5 \pm 0,5$ [air cooling - 0,2 m/s]

General technical data

r.m.s. value according to current waveform.

one capacitor diameter

Function	Mean value	R.m.s. value	Function	Mean value	R.m.s. value	Function	Mean value	R.m.s. value
	$A (t_0/T)$	$A \sqrt{t_0/T}$		$A/2$	$A \sqrt{3}$		$2A/\pi$	$A/\sqrt{2}$
	$A (t_1/T)$	$A \sqrt{2t_1/3T}$		$2A/\pi (t_0/T)$	$A \sqrt{t_0/2T}$		$A/2$	$A/\sqrt{3}$
	$A/2 (t_0/T)$	$A \sqrt{t_0/3T}$		$A/2 (t_0/T)$	$A \sqrt{t_0/3T}$		0	A

6.4.3. Dissipated power versus case dimension

For calculations of ripple currents, considering an internal

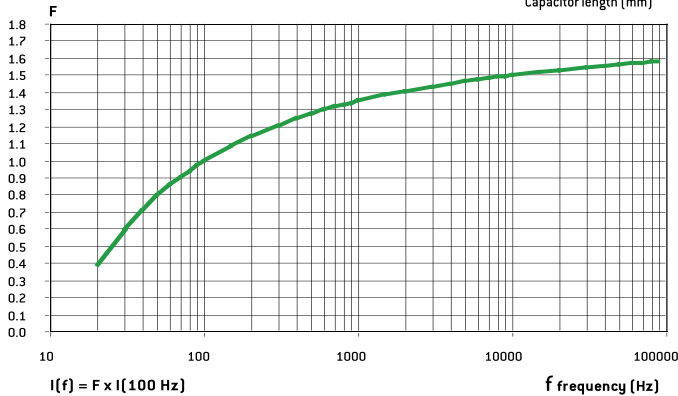
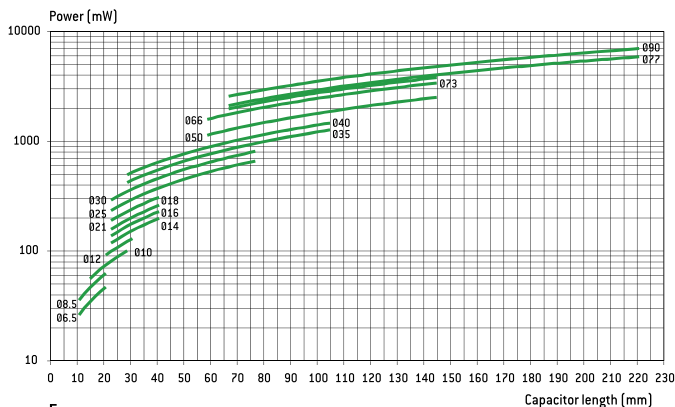

temperature rise of 10°C

$$P = ESR \cdot I^2$$

P = Dissipated power (mW)

($\Theta_i - \Theta_a = 10^\circ\text{C}$)

ESR: Equivalent series resistance (100 Hz 20°C)

I: Ripple current (r.m.s. value at 100 Hz)

For different frequencies from 100 Hz, I must be multiplied by the factor F, according to above chart.

6.4.4. Thermal resistance Rth and air cooling

Rth is static thermal resistance (without cooling) between capacitor central hot spot and ambient temperature measured at a distance of

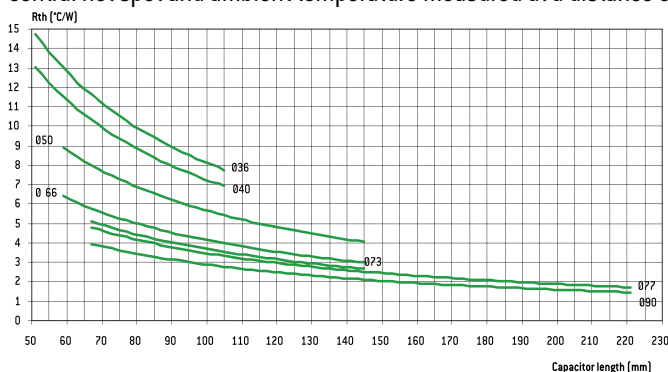

Forced or not cooling air can lead to a significant decrease of these values.

Consequently, r.m.s. ripple current can be increased as a function of air cooling speed:

Ø mm (inches)	≤ 0,5 m/s	1 m/s	2 m/s	3 m/s	≥ 4 m/s
66 - 90	1~	1,1~	1,2~	1,25~	1,3~
36 - 51	1~	1,2~	1,4~	1,45~	1,5~

This parameter shall be applied to one capacitor alone.

For capacitors in bank, ambient temperature must be strictly equal around all capacitors.

6.4.5. Quality guaranty

We guarantee products manufactured during 2 years from the data of shipment against defaults of material and assembly.

This guaranty can be involved by the buyer only if our products are used within normal conditions, always according to the state of the art and taking in account storage conditions.

The equipment design should take into consideration possible failures of our capacitors and related effects in order to avoid them.

Guaranty is not applicable for damages occurred by surge voltage, irregular use, polarity inversion or maintenance default.

Guaranty is exclusively limited to the replacement of individual defective capacitors within the terms of delivery. This rule applied to all cases and particularly to any further consequence of failures.

6.4.6. Reliability

Failure rate: _____

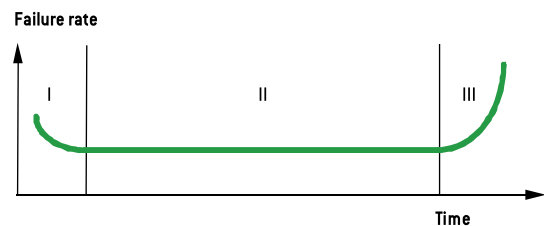

$$FR = \frac{\text{Number of components tested} \times \text{test duration}}{\text{Number of failures}}$$

Failure rate is measured in FIT (failure in time = 10^{-9} / hour).

The failure rate is set up during the life time of the capacitor (phase II)

I. Early failure phase (generally excluded during ageing process).

II. Operational life time of the capacitors

III. End of life

General technical data

Mean time between failures MTBF = 1/FR mesured in years

Range	Failure rate for a failure percentage not exceeding 1% with a confidence level of 60 %
FELSIC 85 >350 V FELSIC HC > 350 V SNAPSIC - SNAPSIC HC > 350 V SNAPSIC 4P > 350 V PROMISIC 031 Ø = 6,5 SICAL CO 42 - SICAL > 350 V	50 FIT - (MTBF = 2280)
FELSIC 037 - 039 FELSIC 85 ≤ 350 V FELSIC HC ≤ 350 V CUBISIC CI FRS SNAPSIC 105 - SNAPSIC 105 4P SNAPSIC 105 LP - SNAPSIC HV SNAPSIC - SNAPSIC 4P ≤ 350 V SNAPSIC HC ≤ 350 V ALSIC IR - ALSIC 145 - ALSIC HV - VACSIC 150 - VACSIC SICAL CO 42 - SICAL ≤ 350 V PRORELSIC 125 Ø = 6,5 RELSIC 033 PROMISIC 031 Ø > 6,5	25 FIT - (MTBF = 4560)
FELSIC 125 FRS - SNAPSIC 125 FELSIC HV - FELSIC 105	10 FIT - (MTBF = 11410)
PRORELSIC 125 Ø > 6,5 PRORELSIC 145	5 FIT - (MTBF = 22820)

Multiplying factor of FR with voltage and temperature

	Temperature (°C)							
	≤ 40	50	60	70	85	105 (1)	125 (1)	145 (1)
Factor	1	1,5	2,3	3,4	6,3	14	32	72

(1) Only for permitted capacitors

	Percentage of rated voltage (2)		
	100 %	80 %	50 %
Factor	1	0,8	0,5

(2) This voltage has to be constant

Environ- ment	Without vibration		Ground with vibrations or mob ile			
	Ground, fix Controlled air	Ground, fix	PRORELSIC SNAPSIC 20 g FELSIC 20 g	FELSIC 10 g PROMISIC SICAL Ø ≤14	CI FRS - SNAPSIC RELSIC SICAL Ø >14	ALSIC
Factor	1	2	2	4	6	12

7. MANUFACTURING FLOW CHART

Process controls

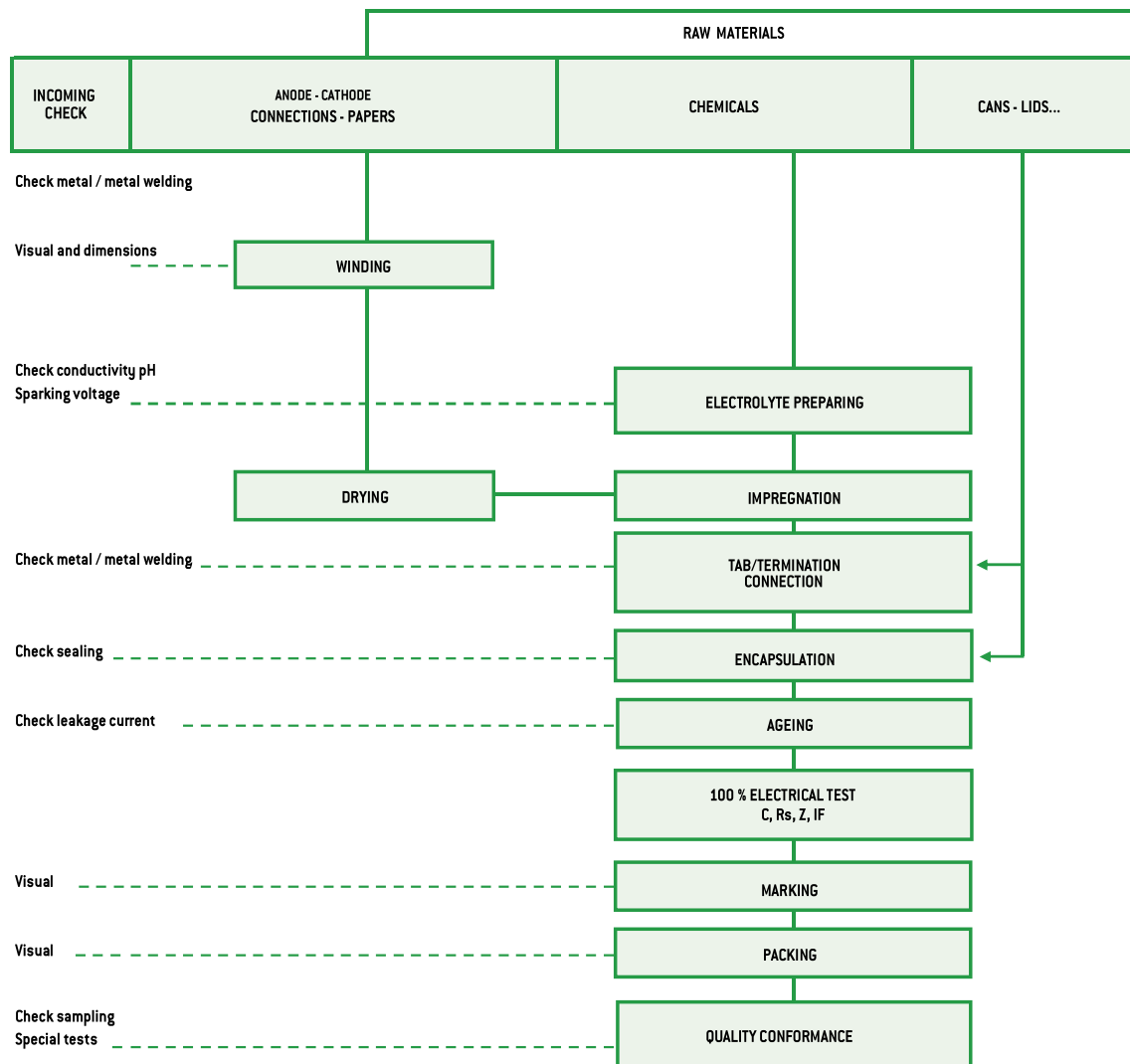

General technical data

8. INFORMATION ON APPLICATION

8.1. CLEANING SOLVENTS

Use aliphatic alcohols, such as denatured ethyl alcohol, isopropanol, or butylacetate, or else alkaline diluted solutions. Avoid incompatible solvents (halogenous for example).

8.2. SHELF LIFE

There is no electrical characteristics variation for long periods of storage except leakage current which can increase.

It is caused by chemical reactions between the dielectric alumina and the electrolyte. These reactions are reversible when switched on. Capacitors can generally be stored at temperature between -5° and $+50^{\circ}\text{C}$ without reforming for the following periods of time:

- For $U_R \leq 100\text{ V}$, storage time: 5 years (up to 10 years under specific conditions)
- For $100\text{ V} < U_R \leq 360\text{ V}$ storage time: 3 years
- For $360\text{ V} < U_R < 500\text{ V}$ storage time: 1 year
- For $U_R \leq 500\text{ V}$, storage time: 6 months

Generally when these periods are overstepped, one hour at rated voltage causes the decrease of leakage current under the specified limits. An other way to avoid this leakage current increase problem is to always limit available power through capacitor during first seconds or minutes after storage or transport, according to the following chart:

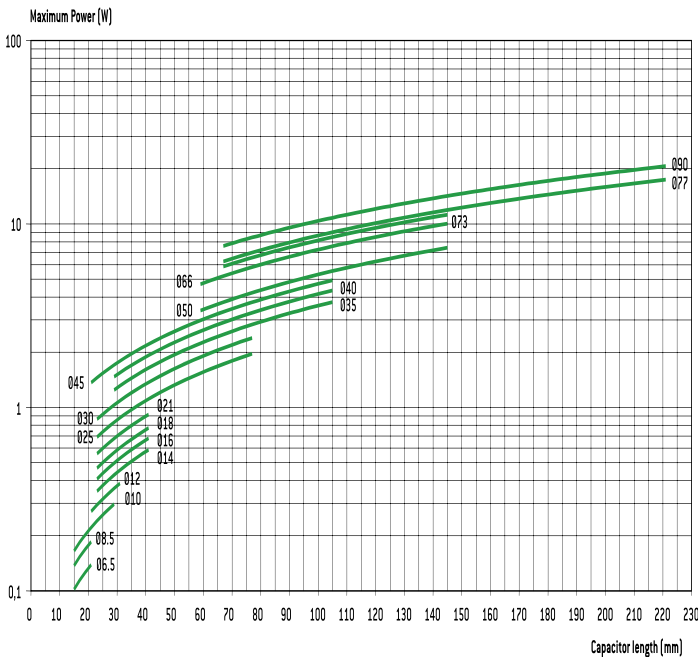

8.3. LOW PRESSURE RESISTANCE

EXXELIA capacitors can be used with ambient low pressure decreasing up to 10 mbar (altitude 28000 m – 92000 feet).

8.4. MOUNTING SCREW TERMINALS CAPACITORS (FELSIC)

Capacitors may be used vertically (terminals on top) or horizontally. When used horizontally, the following position in relation to the safety vent, is recommended:

Mounting capacitors in series may be used for operating voltage exceeding U_R . See FELSIC in bank.

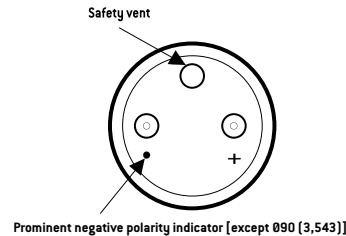

8.5. MOUNTING SOLDER TYPE CAPACITORS.

They may be used in any position. During mounting, avoid applying excessive force to capacitor pins or wires. There is a risk of damaging internal connections.

After soldering and for the same reasons, do not try to move the capacitor's body.

8.6. ELECTROLYTES: SAFETY RULES.

Electrolytes used in EXXELIA capacitors are manufactured by EXXELIA. Main solvents are generally γ butyrolactone and ethylene glycol, very stable high boiling point solvents. Ionic conductive salts in electrolyte induce a very weak acidity (pH 5 to 7).

8.7. ENVIRONMENT.

In aluminium capacitors with liquid electrolyte there is no component showing a pollution risk, in small amounts, of air or water. EXXELIA is always involved in this security field particularly in using chemicals for electrolyte, without well-known risks.

- Dimethylformamide (DMF) dangerous solvent forbidden in several uses is completely excluded by EXXELIA, since 1990.
- There is no halogen compound such as chlorofluorocarbon (CFC or FCKW in German) or polychlorobiphenyl (PCBPyrallene) or pentabromodiphenylether or octabromodiphenylether.

There is neither benzene, toluene or phenyl compound nor explosive such as picric acid, nor asbestos in plastic covers. All the capacitors made by EXXELIA since 1991, can be scrapped or used in raw materials recycling processes without special care in compliance with Community rules.

EXXELIA aluminium capacitors with non-solid electrolyte are particularly suitable for different kinds of environment taking in account severity increasing laws.

European directives 2003/11/EC, 2002/96/EC (WEEE) and 2002/95/EC (RoHS) applies to all EXXELIA capacitors including every solder type, manufactured with pure tin coated pins or wires, since at least January 2006.

Mounting and insulating parts

STUD FIXING: FELSIC BD

Steel nut, spring washer and insulating washer are delivered loosely with the capacitor.

STANDARD MOUNTING WITH:

Insulating washer and steel nut

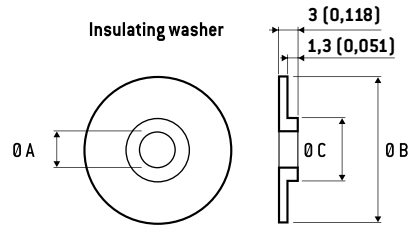
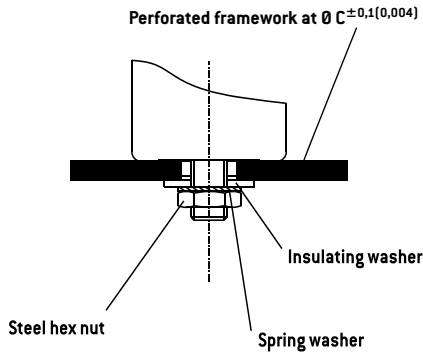

Ø Capacitor	DIMENSIONS in mm (inches)				
	M	Ø A	Ø B	Ø C	Code
36	8	8,4	25	18,5	A 691060
51 - 77	12	12,5	30	21,5	A 691061
90	12	12,5	35	21,5	A 691062

Insulating plastic nut with or without insulating washer

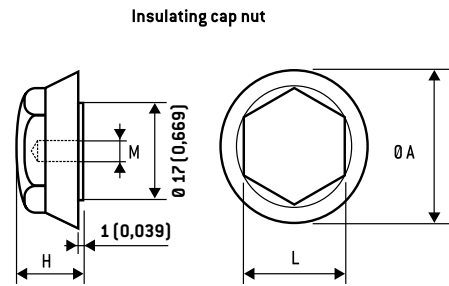
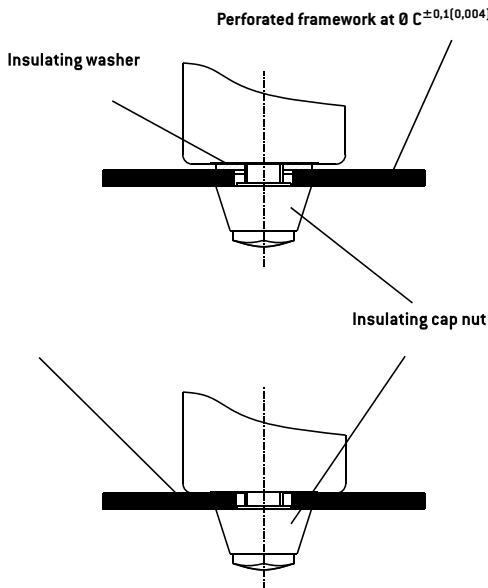

DIMENSIONS in mm (inches)					
M	Ø A	H	L	Max. torque	Code
8 (0,315)	25 (0,984)	15 (0,591)	17 (0,669)	3 Nm	A 691070
12 (0,472)	30 (1,181)	20 (0,787)	19 (0,748)	7 Nm	A 691071

Ring - clip mounting: FELSIC LP

Ring clips shall be ordered separately.

Tightening screws and nuts are supplied loosely.

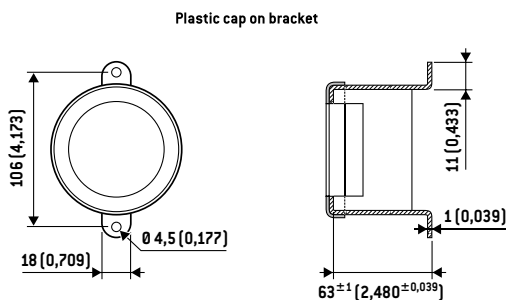

FELSIC 85 LP FELSIC 105 LP	Code
Metal bracket	A691055
Plastic cap	A691065

General technical data

Ring - clip mounting: FELSIC BC

Ring clips shall be ordered separately.

Tightening screws and nuts are supplied loosely.

FELSIC BC - Metal ring-clips

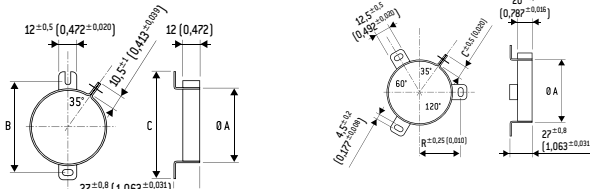

Ø A Cap.	B	C	Code	Ø A Cap.	B	C	Code
36	54	63	A 691901	51	33,5	11,8	A 691905
				66	39	10,5	A 691913
				73	44	10,5	A 691914
				77	44,5	10,5	A 691907
				90	53,3	11,8	A 691915

Stirrup mounting: CUBISIC LP

Stirrups shall be ordered separately.

Tightening screws and nuts are supplied loosely

Salt mist endurance of screws and mounting accessories:
minimum 96 h (IEC 600 68-2-11)

CUBISIC /CUBISIC LP - Metal bracket

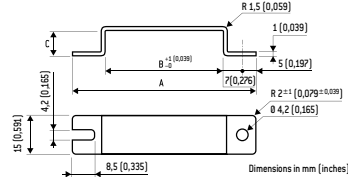

Ø A Cap.	A	B	C	Code
45x12 (1,772x0,472)	69 (2,717)	45 (1,772)	10 (0,394)	A 691057
35x16 (1,378x0,630)	59 (2,323)	35 (1,378)	14 (0,551)	A 691059

PACKAGING

1. PACKAGING AND WEIGHT UNITS.

1.1. Capacitor with screw terminals

Can DIMENSIONS in mm (inches)				Unit weight *
Ø	H			(g)
36 (1,417)	47 (1,850)	52 (2,047)	53 (2,087)	70
36 (1,417)	60 (2,362)			79
36 (1,417)	80 (3,150)	81 (3,189)		100
36 (1,417)	104 (4,094)	105 (4,134)		120
51 (2,008)	47 (1,850)			80
51 (2,008)	62 (2,441)	63 (2,480)		105
51 (2,008)	81 (3,189)	82 (3,228)		190
51 (2,008)	104 (4,094)	105 (4,134)		260
51 (2,008)	112 (4,409)			270
51 (2,008)	144 (5,669)			370
66 (2,598)	104 (4,094)	105 (4,134)		430
66 (2,598)	112 (4,409)			460
73 (2,874)	104 (4,094)	112 (4,409)		600
73 (2,874)	144 (5,669)			680
77 (3,031)	104 (4,094)	105 (4,134)		620
77 (3,031)	144 (5,669)	145 (5,709)		860
77 (3,031)	200 (7,874)			1300
77 (3,031)	220 (7,874)	221 (8,701)		1400
90 (3,543)	67 (2,638)			600
90 (3,543)	144 (5,669)	145 (5,709)		1400
90 (3,543)	200 (7,874)			1800

* Unit weight = typical values

Possible variations of = ± 25 % according to different voltage and capacitance.

1.2. Radial solder types

Can dimensions mm (inches)		ALSIC	SNAP-SIC	Can dimensions		AL-SIC	SNAP-SIC
Ø	H	Weight* (g)		Ø	H	Weight* (g)	
10 (0,394)	16 (0,630)	1,8	-	35 (1,378)	30 (1,181)	-	50
12,5 (0,492)	21 (0,827)	4,5	-	35 (1,378)	40 (1,575)	-	50
12,5 (0,492)	24 (0,945)	5	-	35 (1,378)	45 (1,772)	-	52
				35 (1,378)	50 (1,969)	-	60
16 (0,630)	25 (0,984)	8,2	-	35 (1,378)	75 (2,953)	-	95
				35 (1,378)	100 (3,937)	-	125
22 (0,866)	25 (0,984)	-	15	40 (1,575)	40 (1,575)	-	65
22 (0,866)	30 (1,181)	-	17	40 (1,575)	50 (1,969)	-	100
22 (0,866)	40 (1,575)	-	18	40 (1,575)	75 (2,953)	-	130
				40 (1,575)	100 (3,937)	-	170
25 (0,984)	25 (0,984)	-	17	45 (1,772)	21 (0,827)	-	50
25 (0,984)	30 (1,181)	-	20	45 (1,772)	0,984	-	60
25 (0,984)	35 (1,378)	-	22	45 (1,772)	30 (1,181)	-	73
25 (0,984)	40 (1,575)	-	25	45 (1,772)	35 (1,378)	-	85
25 (0,984)	45 (1,772)	-	28	45 (1,772)	45 (1,772)	-	110
25 (0,984)	50 (1,969)	-	30	45 (1,772)	75 (2,953)	-	180
				45 (1,772)	100 (3,937)	-	240
30 (1,181)	25 (0,984)	-	28				
30 (1,181)	30 (1,181)	-	30				
30 (1,181)	35 (1,378)	-	30				
30 (1,181)	40 (1,575)	-	40				
30 (1,181)	45 (1,772)	-	45				
30 (1,181)	50 (1,969)	-	50				

Can DIMENSIONS in mm (inches)			CUBISIC
I	L	H	weight (g)
35 (1,378)	35 (1,378)	16 (0,630)	30
35 (1,378)	50 (1,969)	16 (0,630)	40
45 (1,772)	35 (1,378)	12 (0,472)	30
45 (1,772)	50 (1,969)	12 (0,472)	45
45 (1,772)	75 (2,953)	12 (0,472)	60

* Unit weight = typical values

Possible variations of = ± 25 % according to different voltage and capacitance.

1.3. Axial types

Can DIMENSIONS in mm (inches)		PRORELSIC RELSIC	PRORELSIC PROMISIC	SICAL CO 42 SICAL
Ø	H	Unit weight * (g)	Unit weight * (g)	Unit weight * (g)
6,5 (0,256)	15 (0,591)	-	1,6	-
6,5 (0,256)	19 (0,748)	-	1,8	1,8
8,5 (0,335)	19 (0,748)	-	2,3	2,3
10 (0,394)	19 (0,748)	-	2,8	2,8
10 (0,394)	25 (0,984)	-	3,5	3,5
10 (0,394)	28 (1,102)	-	3,8	-
12 (0,472)	25 (0,984)	-	5	-
12 (0,472)	30 (1,181)	-	5,4	5,4
14 (0,551)	30 (1,181)	-	6,9	6,9
14 (0,551)	41 (1,614)	-	9,5	-
	30 (1,181)	7,7	-	7,7
18 (0,709)	35 (1,378)	13,6	-	-
18 (0,709)	40 (1,575)	15,3	-	15,3
21 (0,827)	40 (1,575)	19,5	-	19,5
25 (0,984)	40 (1,575)	28	-	28
25 (0,984)	50 (1,969)	35	-	35
25 (0,984)	75 (2,953)	56	-	56

* Unit weight = typical values

Possible variations of = ± 25 % according to different voltage and capacitance.

General technical data

2. PACKAGING ON TAPE

2.1. Axial types

Dimensions and tolerance in accordance with IEC 60 286-

(1) On tape only on request

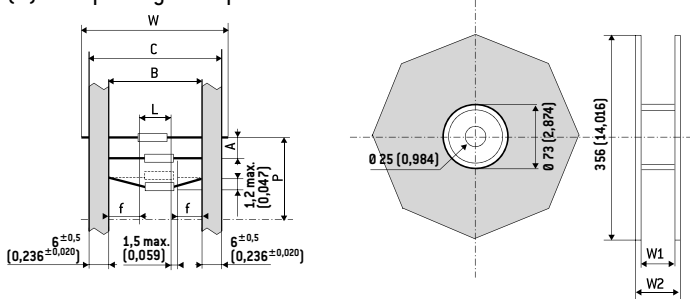

DIMENSIONS in mm (inches)									
D	L max.	B	A	P	C max.	W ₁	W ₂ max.	W	n ⁽²⁾
6,5 (0,256)	20 (0,787)	73 ^{±1,5}	10 ^{±1,5}	± 2 (0,079)	87,5 (3,445)	93 (3,661)	106 (3,661)	85 ^{±1,5}	1000 (39,370)
8,5 (0,335) ⁽¹⁾		(2,874 ^{±0,059})	(0,394 ^{±0,059})					(3,346 ^{±0,059})	750 (29,528)
10 (0,394) ⁽¹⁾	32 (1,260)	73 ^{±1,5}	15 ^{±1,5}	± 3 (0,118)	87,5 (3,445)	93 (3,661)	106 (3,661)	85 ^{±1,5}	400 (15,748)
12 (0,472) ⁽¹⁾		(2,874 ^{±0,059})	(0,591 ^{±0,059})					(3,346 ^{±0,059})	400 (15,748)
14 (0,551) ⁽¹⁾									200 (7,874)

(2) n = number of capacitors per reel.

White positive tape f: > 20 mm (0,787 inches)

P: 10 space