

R9209

RECTILINEAR - CONDUCTIVE POLYMER
PRECISION POTENTIOMETER



High Performances



High temperature up to +125°C

PRESENTATION

The R9209 precision potentiometer is manufactured and tested according to NF C 93255 and MIL PRF 39023 standards.

The housing is made of anodized aluminum and brass/Zn, stainless steel shaft and precious metal multifinger wipers.

R9209 model is supplied with AWG 26 flexible wires, length 250 mm. It can be equipped either return or extension spring upon request (see options).

ENVIRONMENTAL DATA

Operating temperature	-55°C to +125°C
Vibrations	20 g, 1.5 mm, 10 Hz to 2 kHz
Shocks	50 g, 1/2 sine, 11 ms.

RESISTANCE [Ω]	ELECTRICAL TRAVEL (mm)			
	10	20	50	100
1000	•	•	•	
2200	•	•	•	•
4700	•	•	•	•
10000	•	•	•	•
Bushing L (mm)	33	43	73	123
Servo L (mm)	36	46	76	126

OPTIONS

	Bushing	Servo
Threaded holes	•	
Shaft Ø 3,175 - different length	•	•
Sealed shaft (IP54)		•
Medium tap	•	•
Other Resistance	•	•
Other Linearity	•	•
Potentiometer + switch	•	•
Output 4-20 mA 2 wires	•	•
Threaded shaft M 3 x 10	•	•
Other electrical travel	•	•
Ball on shaft's extremity	•	•
Carbide touch head	•	•
Return or extension spring	•	•

For other specifications, please contact us

DIMENSIONS (in mm)

R9209 B Model - Bushing mounting

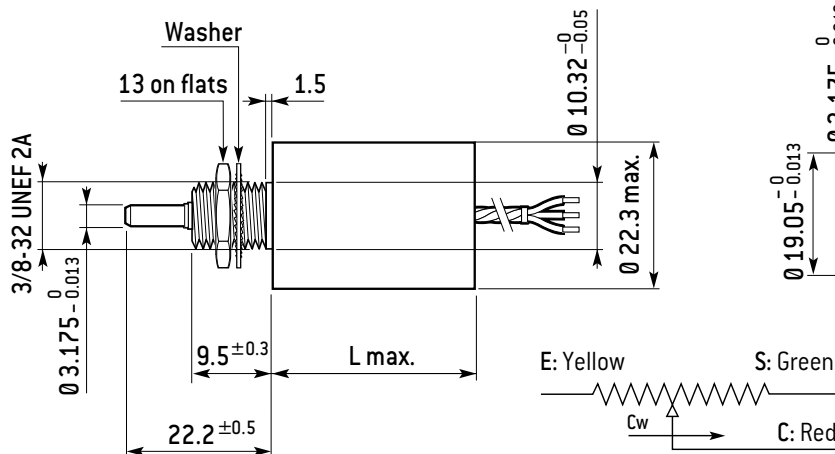

R9209 S Model - Servo mounting

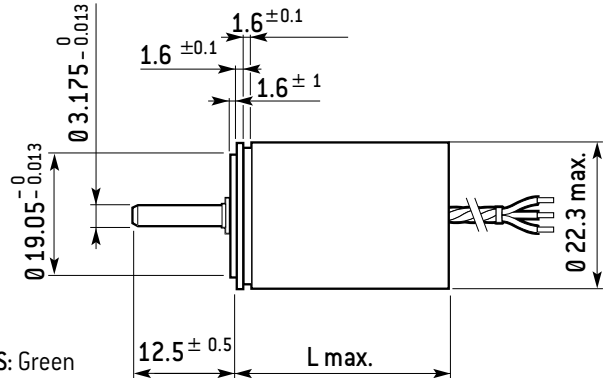

RECTILINEAR - CONDUCTIVE POLYMER
PRECISION POTENTIOMETER**R9209**

STANDARD ELECTRICAL DATA

Nominal resistance	10 kΩ
Resistance tolerance [Rn] at 20°C	± 20 %
Independent Linearity	± 1 %
Maximal dissipation at 70°C	0.05 W
Temperature coefficient	$-200 \pm 200 \times 10^{-6}/^{\circ}\text{C}$
Output smoothness	≤ 0.1%
Wiper current	≤ 1 mA
Insulation resistance at 500 V	≥ 1 000 MΩ
Withstand voltage (50 Hz, 1 mn)	500 V
Ratio residual voltage/applied voltage	≤ 0,5 %

MECHANICAL CHARACTERISTICS

Size	09
Housing diameter	22.3 mm max.
Starting force	≤ 2 N
Torque on bushing	≤ 2.5 N.m
Torque on bushing	≤ 1 N.m
Number of elements	2 max.
Lifetime (travels)	≥ 10 x 10 ⁶
Displacement speed	≤ 1 m/s

HOW TO ORDER

	Mounting	Nominal resistance (in code)	Linearity in code [±%]	Electrical travel (mm)	Option* in code	RoHS compliance
R9405	•	•••	•	•••	••	•
	B	470	Z	010	00	W
	S	to	to	to	01	N
		10M	F	100	02	
					...	

B: Bushing
S: Servo

470: 470 Ω
1K0: 1 000 Ω
4K7: 4 700 Ω
10M: 10 MΩ
etc.

Z: ±0.025%
A: ±0.05%
B: ±0.1%
C: ±0.25%
D: ±0.5%
F: ±1%

010: 10 mm
100: 100 mm
etc.

00: No option
01: Option 1
02: Option 2
etc.

W: RoHS compliant
N: Non compliant

* For options, please contact us.

Potentiometers General information

1. INTRODUCING EXXELIA GROUP POTENTIOMETERS

For over 50 years, EXXELIA GROUP has been developing potentiometric sensors for civil and spatial applications and for the defense sector. EXXELIA GROUP has special know-how in the two basic manufacturing techniques used to produce potentiometer sensor tracks:

- **Conductive film technology**
- **Wirewound technology**

Apart from the different technologies used, these potentiometers break down into several families:

- rotary potentiometers (for copying positions or driving rotary systems),
- single-turn or multi-turn potentiometers
- pancake potentiometers (monobloc with a mobile “wiper” part inseparable from the shaft and no ball bearings),
- Linear motion potentiometers (for copying positions or driving systems with linear translation motion),
- digital potentiometers (equipped with an analog-digital converter → 16 bits),
- rotary switches providing discrete signals on multiple bits and used for example to define angular sectors (used to set limits for security sectors when mounted on weapon station Slip rings).

Summary definitions of terms related to non-wirewound (conductive polymer) precision potentiometers as per standard NF C 93255 and MIL R 39023 and to wirewound potentiometers as per standard NF C 93265 and MIL R 12934:

Nominal resistance (R_n): rated label value of the potentiometer.

Total resistance (R_t): value measured between the input and output, R_t should be between the R_n + and the R_n – tolerances.

Effective electrical travel: value in degrees of angular deviation corresponding to an effective variation in resistance. See fig. 1, which also shows total electrical travel and mechanical travel. Two possibilities are presented: fig. 1A for continuous rotation single turn potentiometers and fig. 1B for single or multi-turn potentiometers with stops.

Standardized definitions for mechanical travel and electrical travel:

Fig. 1A - Single or multi-turn potentiometer with stops.

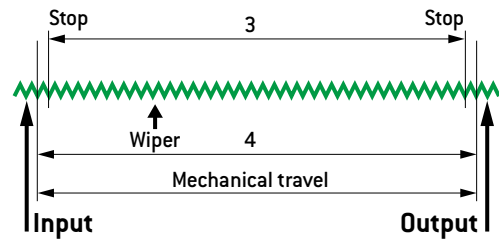
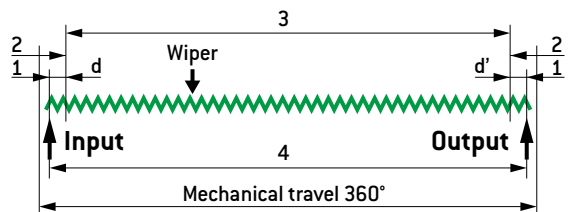

Fig. 1B - Single-turn continuous rotation potentiometer.



1. dead space (electrical discontinuity)
 2. non-conformity space (difference between the 360° mechanical travel and the actual electrical travel, fig. 1A)
 3. effective electrical travel (value corresponding to an effective variation in resistance in which conformity is verified)
 4. total electrical travel (in the example in fig. 1B the total electrical travel, or mechanical travel, may be taken for the effective electrical travel)
- dd'** - overtravel (as in fig. 1A)
- single turn potentiometer: mechanical travel at less than 360°
 - n-turns potentiometer mechanical travel greater than n, 360°

Movement: a movement includes the clockwise and counterclockwise travels of the shaft

Backlash: value in degrees of the angle of rotation that does not result in any contact travel during a change in direction

Function: the relationship between the electrical value to be obtained (theoretical function) or obtained (actual function) at the output terminals and the wiper position in the actual electrical travel

Conformity deviation: positive or negative deviation in the values of the functions desired and obtained for each wiper position linearity deviation for linearity function

Potentiometers General information

Conformity: percentage between the maximum conformity deviation (absolute value) and the maximum electrical value measured between input and output, as in fig. 1A and 1B. linearity, for linearity function.

Corrected deviation: absolute value of the deviation between the best curve of the effective electrical travel minimizing the deviations and the curve representing the desired function.

Fig. 2 - Independent linearity curve

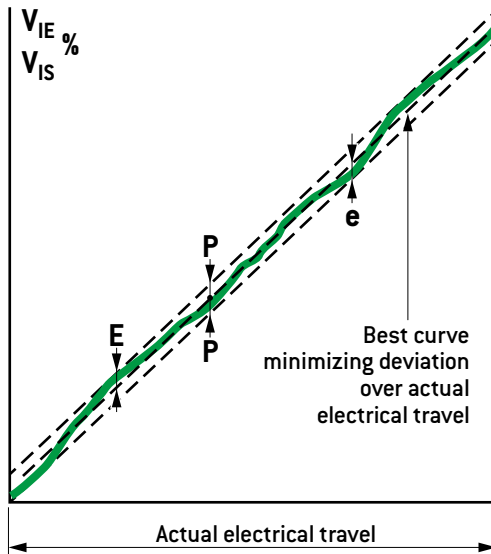

- V_{IE} Voltage between input and wiper
- V_{IS} Voltage applied to potentiometer terminals
- E Upper deviation
- e Lower deviation
- P Conformity tolerance $\frac{E+e}{2} < P$
- Authorized deviations

Independent conformity: percentage between the absolute value of the maximum corrected deviation and the maximum electrical value measured between input and output Independent linearity for the linearity function.

Theoretical angular resolution: rotation angle formed by the wiper passing from one turn to the next. For a linear variation law it is the quotient of the total electrical travel over the number of turn. For a non-linear variation law the angle may vary in function of the wiper position. For the conductive polymer technology, the resolution is consider as "infinite".

Equivalent noise resistance (wirewound potentiometers): quotient of the maximum peak voltage [read on an oscilloscope as specified in standards] measured at the output during wiper travel, and the constant DC voltage at the wiper.

Output smoothness (nonwirewound potentiometers): ratio expressed in percentage of the greatest variation between the output voltage (measured as specified by the standards) and the applied voltage on the input.

Fig. 3 - Plastic Film potentiometer

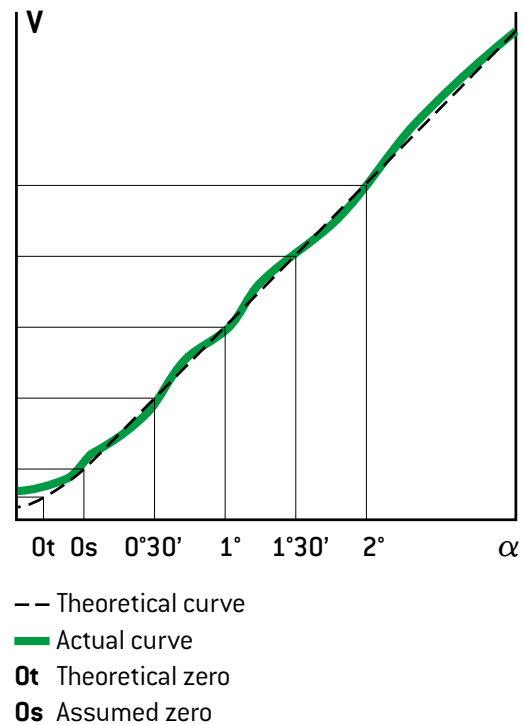
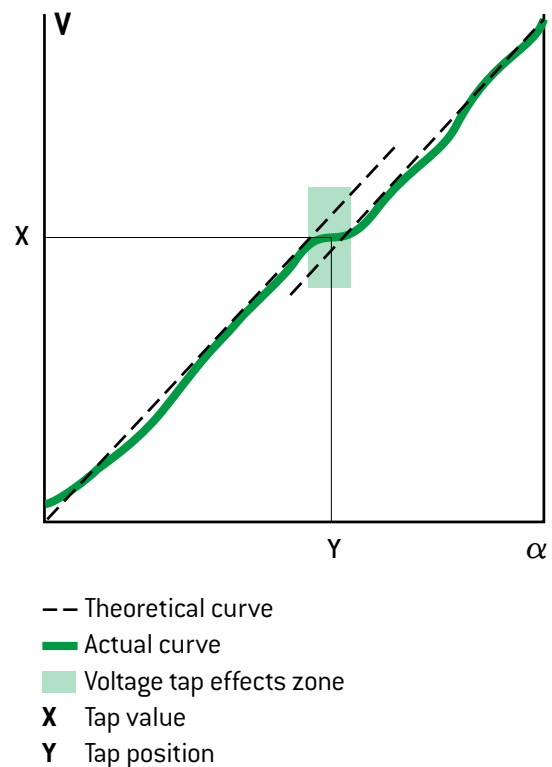

Fig. 4 - Voltage tap effects



Potentiometers General information

EXXELIA^{GROUP} standard production precision potentiometers are manufactured using the technology wirewound or conductive polymer (norm/virewound).

Conformity to standards is given for each type, but performance after endurance tests is always superior to the even most stringent specifications presently applicable.

The Following specific characteristics of each technology are proceeded, when applicable by one of the followings sign:

NOTE	CHARACTERISTIC
++	Extremely favourable characteristic
+	Favourable characteristic
	Normal characteristic
-	Less favourable characteristic

2. WIREWOUND TECHNOLOGY

The main characteristics of this standard technology are as follows:

+ Low resistance:

The Wirewound technique enables the production of components with low ohmic values (from 100 ohms).

Independent conformity:

In general for the linear function, the independent linearity is maintained when requested, at a value within a range linked to the geometric parameters of the potentiometer (between $\pm 0.5\%$ and 2% for size 05, between $\pm 0.05\%$ and 0.5% for sizes 20 or 30 for single turn potentiometers; between $\pm 0.01\%$ and $\pm 0.25\%$ for multi-turn potentiometers).

++ Contact resistance:

Very low. The metal to metal contact resistance is situated at a value of approximately 200 milliohms.

+ Output current:

Since the contact resistance is very low, the current travelling through the wiper is in large part determined by the wire diameter (lower as the resistance of the potentiometer is higher) and by the size of the potentiometer (10-30mA for a 10 000 ohms potentiometer from size 05 to size 30).

- Theoretical angular resolution:

The turns/degrees ratio indicates output voltage variation by values which are increasingly discrete as the number of turns increases, Resistance is thus higher (0.6 to 1.5 turns/degrees from size 05 to size 18 for a resistance of 100 ohms, 2.3 to 8.5 turns/degrees from size 05 to size 30 for a resistance of 10 kohms; most favorable cases where no turn is "bypassed").

- Equivalent noise resistance:

Voltage variations which appear during wiper travel from one turn to the next enable determination of the equivalent noise resistance (value set by standard at less than or equal to 25 ohms, may be decreased, for example, to less than or equal to 1 ohm for a 10 kohm potentiometer, size 18).

+ Temperature coefficient:

The potentiometer temperature coefficient strictly speaking is directly a function of the temperature coefficient of the wire used (less than or equal to 20 ppm/°C for average values).

- Performance versus frequency:

The input and output impedances depend on several parameters: coil length, wiper position, resistance value and type of case. The frequency range is limited (quadrature voltage: 0.1% for Rn 1 kohm, With F= 1 kHz, 2% for Rn 100 kohm, with F = 200 Hz).

Life:

The abrasion of the wire produced by the friction between the wiper and the coil has a detrimental effect on the linearity and increases the resistance value, particularly in the frequent case of travel limited to a small portion of the coil (specifications indicated for each type, average endurance at 40 rpm: 10^5 shaft revolutions or $5 \cdot 10^5$ movements). A life exceeding $1 \cdot 10^7$ shaft revolutions may be obtained in certain specific cases. Specific studies upon request.

Potentiometers General information

3. CONDUCTIVE POLYMER TECHNOLOGY (NON-WIREWOUND)

The principal characteristics of this technology are summarized below.

+ Absolute conformity:

The conformity range linked to the geometric parameters of the potentiometer is more or less comparable to that of Wirewound potentiometers. However, the travel correction principle enables obtention of much superior precision.

– Contact resistance:

Higher than that of a wirewound potentiometer, it varies from tens to several hundred ohms (for example, 80 ohms for a 10 kohm size 18 potentiometer).

– Output current value:

To avoid heating by Joule effect at the contacts and resulting microdestruction of the conductive polymer path, the current flowing through the wiper, or output current, must be limited (milliampere value).

+ Almost infinite resolution:

Because of the perfectly polished nature of the surface of the conductor material with which the conductive polymer is doped (granulation measured in angstroms $1 \text{ \AA} - 10^{-10} \text{ m}$), resolution is practically infinite.

++ Output smoothness:

Linked to the proceeding characteristic, this parameter is related to the surface state, the homogeneity of the conductor and to the wiper design. It is expressed as a percent of the Total Applied Voltage. Operational performance better than the guaranteed value of $2.5 \pm 0.025 \%$ is obtained over the total electrical travel.

++ Low temperature performance:

A noteworthy advantage of this technology is that the output smoothness is maintained at very low temperatures (-55°C).

+ Temperature coefficient:

Depending upon the potentiometer value, the temperature coefficient is generally negative.

+ Performance versus frequency:

Parameters having an influence on the input and output impedances remain negligible due to the absence of a coil, for frequencies up to 100 kHz, whatever the potentiometer value and wiper position.

++ Life:

Conductive polymer potentiometers have a life superior to that of wirewound potentiometers, reaching $25 \cdot 10^6$ shaft revolutions at 400 rpm, as long as usage conditions are followed (output current value).