

# Electrolytic Aluminum Capacitors





# Electrolytic Aluminum Capacitors

**EXXELIA** 



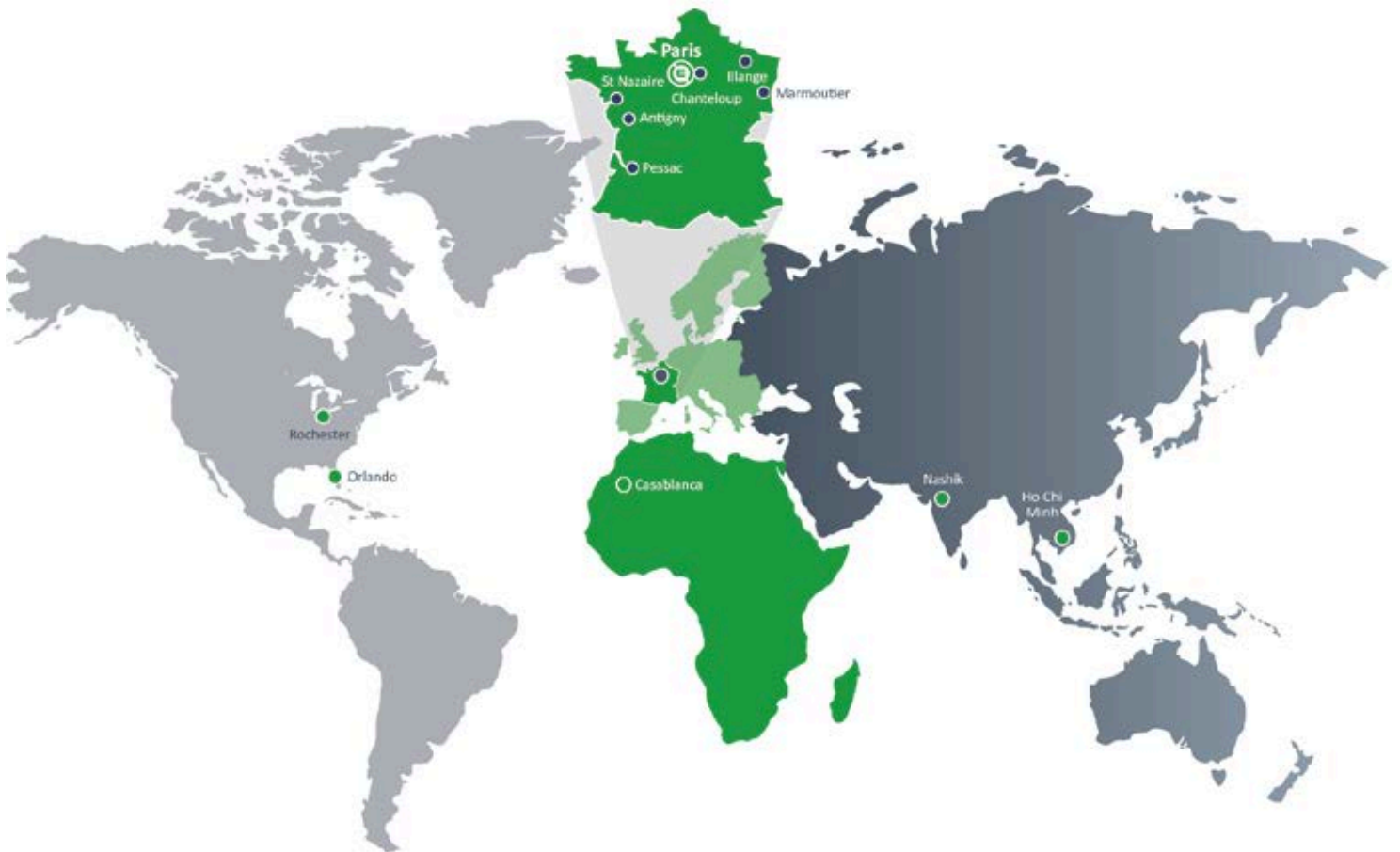





A Worldwide presence







Specifications are subject to change without notice. All statements, information and data given herein are presented without guarantee, warranty or responsibility of any kind, expressed or implied.

# Selection Guide

## SCREW TERMINALS









Reference	Capacitance ( $\mu$ F)	Voltage (V)	Dimensions in mm (inches)		Operating temperature	Main characteristics	Page
			$\emptyset$	H			
 FELCIC 85 (BC) - CO 54 FELCIC 85 (BD) - CO 53	68 to 680 000	10 to 630	36 to 90 (1,417 to 3,543)	52 to 200 (2,047 to 7,874)	-55°C + 85°C	Standard 85°C	16
 FELCIC 039 (BC) - CO 39 FELCIC 037 (BD) - CO 37	100 to 150 000	10 to 400	36 to 77 (1,417 to 3,031)	47 to 144 (1,850 to 5,669)	-55°C + 85°C	Standard C039 type (railway maintenance standard)	22
 FELCIC 85 M (BC) - CO 54 FELCIC 85 M (BD) - CO 53	68 to 330 000	10 to 630	36 to 90 (1,417 to 3,543)	52 to 200 (2,047 to 7,874)	-55°C + 85°C	Standard 85°C $\pm$ 20% tolerance	26
 FELCIC 105 (BC - BD)	100 to 470 000	16 to 450	36 to 90 (1,417 to 3,543)	52 to 200 (2,047 to 7,874)	-55°C + 105°C	Extreme Long life	31
 FELCIC 105 TFRS (BC - BD) -CO 45	470 to 68 000	10 to 100	36 to 77 (1,417 to 3,031)	47 to 144 (1,850 to 5,669)	-55°C + 105°C	Very low ESR	35
 FELCIC 105 LP (BC)	1 500 to 220 000	10 to 450	90 (3,543)	67 (2,638)	-55°C + 105°C	105 with Low Profile can	38
 FELCIC HC (BC - BD)	100 to 2 200 000	10 to 500	36 to 90 (1,417 to 3,543)	52 to 200 (2,047 to 7,874)	-55°C + 85°C	High energy density	40
 FELCIC HV (BC - BD)	1 500 to 47 000	160 to 450	51 to 90 (2,008 to 3,543)	104 to 200 (4,094 to 7,874)	-55°C + 105°C	Extreme Long life; High ripple	48
 FELCIC 125 FRS (BC) - CO 47 FELCIC 125 FRS (BD) - CO 46	220 to 150 000	16 to 350	36 to 90 (1,417 to 3,543)	53 to 145 (2,087 to 5,709)	-55°C + 125°C	Low ESR	51

## RADIAL LEADED





Reference	Capacitance ( $\mu$ F)	Voltage (V)	Dimensions in mm (inches)				Operating temperature	Main characteristics	Page
			I	L	$\emptyset$	H			
 ALCIC 145 20G	220 to 3 300	12 to 115			20 25 (0,787) (0,984)	18 22,5 (0,709) (0,886)	-55°C + 145°C	High temperature range - Long life withstand 20g vibrations	56
 ALCIC 20G	100 to 80 000	10 to 500			20 25 (0,787) (0,984)	18 to 35,5 (0,787 to 0,984)	-55°C + 105°C	Withstand 20g vibrations	58
 CUBISIC	100 to 33 000	10 to 450	35 (1,378)	35 to 50 (1,378 to 1,969)		16 (0,630)	-55°C + 105°C	Non cylindrical case, Withstand 20g vibrations, High energy density	61
 CUBISIC LP	120 to 68 000	10 to 400	45 (1,772)	12 (0,472)		35 to 75 (1,378 to 2,953)	-55°C + 105°C	Non cylindrical case, Withstand 20g vibrations, High energy density	64

# Selection Guide

## SNAP IN

Reference	Capacitance ( $\mu$ F)	Voltage (V)	Dimensions in mm (inches)		Operating temperature	Main characteristics	Page
			$\emptyset$	H			
 <b>SNAPSIC</b>	22 to 47 000	16 to 500	22 to 35 (0,866 to 1,378)	30 to 50 (1,181 to 1,969)	-55°C + 85°C	Standard 85°C type	<b>68</b>
 <b>SNAPSIC 105</b>	22 to 68 000	16 to 500	22 to 35 (0,866 to 1,378)	25 to 50 (0,984 to 1,969)	-55°C + 115°C	Standard 105°C type	<b>72</b>
 <b>SNAPSIC HC</b>	33 to 47 000	25 to 500	22 to 35 (0,866 to 1,378)	25 to 50 (0,984 to 1,969)	-55°C + 85°C	High energy density	<b>76</b>
 <b>SNAPSIC HV</b>	47 to 2 200	16 to 500	22 to 35 (0,866 to 1,378)	25 to 50 (0,984 to 1,969)	-55°C + 105°C	Long Life; High ripple current	<b>83</b>
 <b>SNAPSIC 4P</b>	330 to 150 000	16 to 500	35 to 45 (0,866 to 1,378)	50 to 100 (1,969 to 3,937)	-55°C + 85°C	Standard 85°C type with 4Pins	<b>86</b>
 <b>SNAPSIC 105 4P</b>	330 to 150 000	16 to 500	35 to 45 (0,866 to 1,378)	50 to 100 (1,969 to 3,937)	-55°C + 105°C	Standard 105°C type with 4Pins	<b>90</b>
 <b>SNAPSIC 105 LP</b>	150 to 68 000	16 to 500	45 (1,772)	16 to 40 (0,630 to 1,575)	-55°C + 105°C	Low Profile 105°C with 4 Pins	<b>93</b>
 <b>SNAPSIC 125</b>	470 to 47 000	16 to 100	22 to 35 (0,866 to 1,378)	25 to 50 (0,984 to 1,969)	-55°C + 125°C	High temperature range - Long Life	<b>96</b>

## AXIAL LEADED

Reference	Capacitance ( $\mu$ F)	Voltage (V)	Dimensions mm (inches)		Operating temperature	Main characteristics	Page
			$\emptyset$	H			
 <b>SICAL</b> <b>SICAL CO 42</b>	2,2 to 47 000	10 to 630	6,5 to 25 (0,256 to 0,984)	15 to 75 (0,591 to 2,953)	-55°C + 85°C	Standard 85°C type	<b>100</b>
 <b>PRORELSIC 125</b> <b>CO 52</b>	1 to 15 000	10 to 450	6,5 to 25 (0,256 to 0,984)	15 to 75 (0,591 to 2,953)	-55°C + 125°C	125°C Long life	<b>106</b>
 <b>PRORELSIC 145</b> <b>CO 52</b>	6,8 to 10 000	16 to 450	14 to 25 (0,551 to 0,984)	30 to 75 (1,181 to 2,953)	-55°C + 145°C	High temperature Long life	<b>112</b>
 <b>VACSIC 105</b>	15 to 4 700	10 to 350	12 to 16 (0,472 to 0,630)	30 (1,181)	-55°C + 105°C	Standard 105°C type Withstand 45g vibrations.	<b>116</b>
 <b>VACSIC 150</b>	6,8 to 3 300	16 to 450	12 to 16 (0,472 to 0,630)	30 (1,181)	-55°C + 150°C	High temperature Long life Withstand 45g vibrations	<b>119</b>

OLD RANGES	REPLACEMENT TYPES	OLD RANGES	REPLACEMENT TYPES	OLD RANGES	REPLACEMENT TYPES
FELSIC 125	FELSIC 125 FRS	CELLSIC	FELSIC HC 10 , 16 V	RELSIC TFRS (CO 43)	SICAL CO 42
FELSIC TFRS (CO 45)	FELSIC 105 TFRS (BC) (CO 45)	CMF FP - CMF	SICAL CO 42 - SICAL	SICAL 025 (CO 25)	SICAL CO 42
FELSIC HP	FELSIC 105 77 x 220	CMF FRS 12.3	SICAL CO 42	SICAL 041 (CO 41)	SICAL CO 42
FELSIC IND (BC - BD) 93.6, 94.6	FELSIC HC FELSIC 85 (BC - BD)	PROMISIC 015 (CO 15)	PRORELSIC 125 (CO 52) PROMISIC 031		
FELSIC UPS	FELSIC HC	PROMISIC 125 (CO 16)	PRORELSIC 125 (CO 52)		
FELSIC 018 (CO 18)	FELSIC 85 BC - FELSIC 039	PROMISIC FRS (CO 32)	SICAL CO 42		
FELSIC 019 (CO 19)	FELSIC 85 BC - FELSIC 039	PROMISIC TFRS (CO 28)	SICAL CO 42		
FELSIC DI	FELSIC 85 480 V - 500 V	PRORELSIC 105 TFRS (CO 48) (2)	PRORELSIC 125 (CO 52)		
FELSIC 036 (CO 36)	FELSIC 037 (CO 37)	RELSIC 026 (CO 26)	PRORELSIC 125 (CO 52) RELSIC 033		
FELSIC 038 (CO 38)	FELSIC 039 (CO 39)	RELSIC 125 (CO 44)	PRORELSIC 125 (CO 52)		

# General technical data

## 1. BASIC CONSTRUCTION

Structure of an electrolytic aluminum capacitor is shown hereunder:

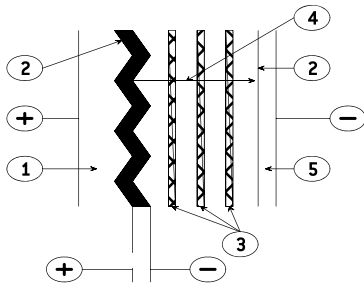

1. Anode: aluminum foil
2. Dielectric: aluminum oxide
3. Papers spacers impregnated with electrolyte
4. Ionic conduction assumed by electrolyte
5. Cathode: aluminum foil

The positive plate is an etched aluminum foil covered with alumina which is the dielectric of the capacitor.

The negative plate is constituted by a second aluminum foil which serves as a current supply, and by electrolyte-impregnated papers layers.

The metal used for anode is a  $\geq 99,98$  % grade aluminum.

The dielectric has a thickness of  $13 \text{ \AA} / \text{V}$ .

The aluminum used for the cathode is a  $\geq 98$  % grade aluminum covered with a dielectric layer with a thickness of about  $40 \text{ \AA}$ .

## 2. DIAGRAM OF THE EQUIVALENT CIRCUIT

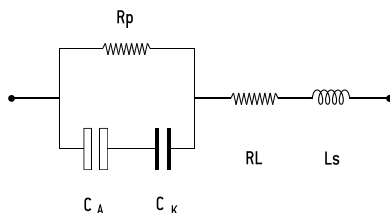

- $C_A$  = Capacitance of the anode
- $C_K$  = Capacitance of the cathode
- $R_p$  = Parallel resistance due to the aluminum oxide film.
- $R_L$  = Series resistance of connections, plates and impregnated spacer.
- $L_s$  = Inductance of winding and connections.

A standard simplified diagram is.

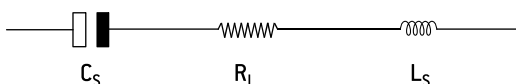

$C_s$  is the series capacitance of both anode and cathode capacitances. Electrolytic aluminum capacitors are naturally polarized because of the insulating film on the anode. Given the very thin aluminum oxide layer, a reversed voltage should not exceed 1.5 V when there is energy supply.

Short duration reverse voltages can be absorbed by special construction, second anode replacing the former cathode.

## 3. CAPACITORS MARKING

### 3.1. ARTICLE CODE (ON EACH PACKAGING)

A followed by 6 figures number. First 3 positions are specific of the range. (Ex. A 745xxx for a FELSIC 85 BD)

140 FELSIC in bank	741 FELSIC 125 FRS BD (ex 731)
701 PRORELSIC 125	742 PRORELSIC 105 TFRS
703 PRORELSIC 125	743 PRORELSIC 105 TFRS
704 SNAPSIC	744 FELSIC 85 BC
705 SNAPSIC 105	FELSIC 85 LP
706 FELSIC HP BC – BD	745 FELSIC 85 BD
708 PRORELSIC 145	746 FELSIC 85 M BC
710 CUBISIC	747 FELSIC 85 M BD
711 PROMISIC 031	748 SICAL CO 42 - SICAL
712 CUBISIC LP	749 SICAL CO 42 - SICAL
713 SNAPSIC 105 LP	750 CUBISIC 125
714 SNAPSIC 4P	756 FELSIC 105 BC
715 SNAPSIC 105 4P	FELSIC 105 LP
716 SNAPSIC HV	757 FELSIC 105 BD
717 SNAPSIC HC	760 FELSIC HC BC
718 SNAPSIC 125	761 FELSIC HC BD
721 RELSIC 033	762 FELSIC 105 TFRS BC
722 CI FRS	763 FELSIC 105 TFRS BD
723 CI FRS	764 FELSIC HV BC
728 FELSIC 039 (ex 727)	765 FELSIC HV BD
FELSIC DI	775 VACSIC
738 FELSIC 037 (ex 737)	774 VACSIC 150
740 FELSIC 125 FRS BC (ex 731)	776 ALSIC 20G
	ALSIC 145 20G

In FELSIC ranges, article code without first letter A, is printed on each capacitor.

a Figure 9 in fourth position shows a special product.

### 3.2. BATCH (ON EACH CAPACITOR).

3 figures or 6 figures

### 3.3. DATE (ON EACH CAPACITOR IF APPLICABLE)

4 figures (year-week)

## 4. ELECTRICAL CHARACTERISTICS

### 4.1. RATED CAPACITANCE $C_R$

The rated capacitance is defined at 100 Hz and at ambient temperature.

### 4.2. RATED VOLTAGE $U_R$

$U_R$  is the maximum DC voltage which may be applied in continuous operation.

When applying a superimposed alternating voltage, the peak value of the resulting waveform should not exceed the rated voltage.

### 4.3. PEAK VOLTAGE $U_p$

$U_p$  is the maximum repetitive voltage which can be applied within short periods.

Defined in CECC 30 300 and IEC 60 384-4:

1000 cycles of 30 s charge followed by a no load period of 5 min. 30 s with upper category temperature.

$$U_p \leq 1,15 U_R (U_R \leq 315 \text{ V})$$

$$U_p \leq 1,10 U_R (U_R > 315 \text{ V})$$

# General technical data

## 4.4. DISSIPATION FACTOR $\tan\delta$

The dissipation or loss factor is defined by its tangent  $\tan\delta$

$$\tan\delta = R_s C_s \omega$$

$$(\omega = 2\pi F)$$

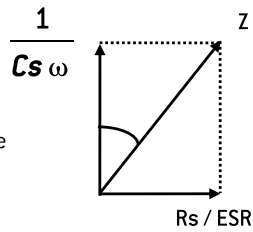

- ESR** Capacitor Equivalent Series Resistance  
**Cs** Capacitor capacitance  
**F** Frequency (100 Hz)  
**Z** Capacitor impedance

## 4.5. EQUIVALENT SERIES RESISTANCE ESR

The relation between ESR and dissipation factor  $\tan\delta$  is given in § 4.4.

## 4.6. IMPEDANCE Z - INDUCTANCE L

The impedance is given by:

$$Z = \sqrt{R^2 + \left[L\omega - \frac{1}{C\omega}\right]^2}$$

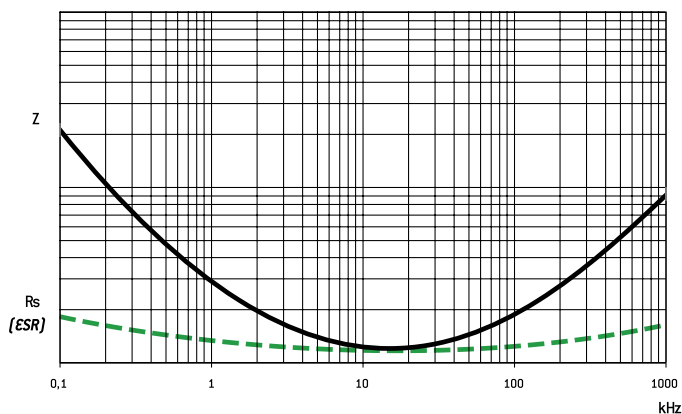

L inductance. Generally L = 5 to 20 nH  
 Z and ESR as function of frequency typically follows the chart:

## 4.7. PERMISSIBLE RIPPLE CURRENT (I r.m.s.) I<sub>r</sub>

The current is defined at the maximum climatic category and at 100 Hz. It is the root mean square value r.m.s. The value I<sub>0</sub> is the rated value for calculations of expected life up to 3 I<sub>0</sub>.

## 4.8. LEAKAGE CURRENT II

II is measured at 20°C after a 5 min. polarization under rated voltage.

For C<sub>R</sub> in μF and U<sub>R</sub> in V:

$$II \leq 0,01 C_R U_R \text{ or } 1 \mu\text{A}^*$$

when C<sub>R</sub> U<sub>R</sub> ≤ 1000 μC

$$II \leq 0,006 C_R U_R + 4 \mu\text{A}$$

when C<sub>R</sub> U<sub>R</sub> > 1000 μC

For U<sub>R</sub> > 350 V<sub>DC</sub> it can be specified:

with K = 4, 6 or 8

or

$$II \leq 0,3 [C_R U_R]^{0,7} + 4 \mu\text{A} \text{ (CECC 30 300)}$$

\* Whichever is the greater

## 4.9. CHARACTERISTICS

Versus temperature (typical values).

### 4.9.1. Capacitance drift

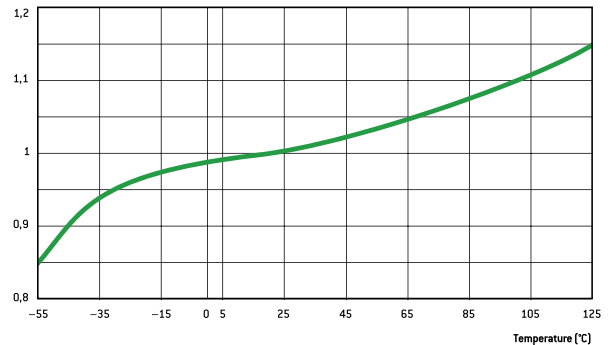

Versus temperature

### 4.9.2. ESR and Z drifts at 100 Hz

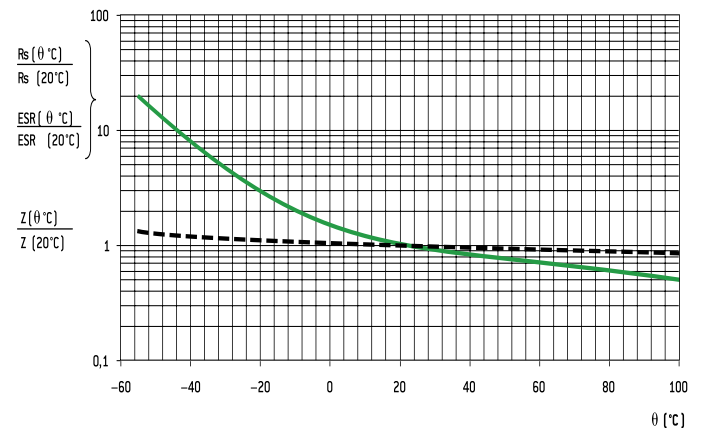

Versus temperature

### 4.9.3 Leakage current drift

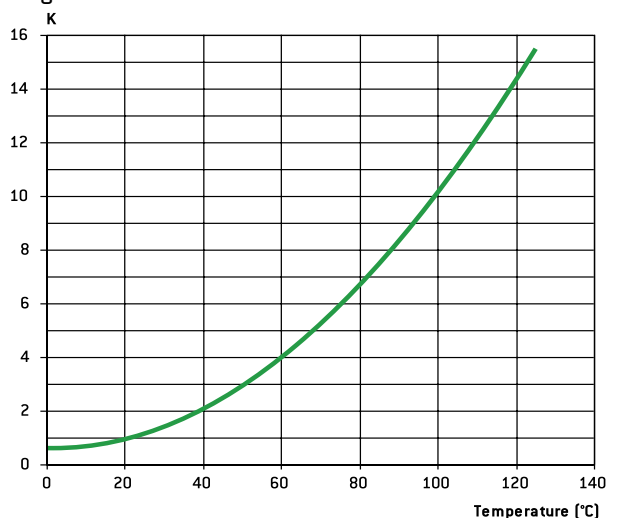

Versus temperature

# General technical data

## 5. SPECIFICATION TO APPLY

Electrolytic aluminum capacitors are defined in:

- NF and UTE French national standard
- CECC European specifications
- IEC international specifications

Quality insurance procedures are described in these specifications.

	French	European	International
Generic specification Fixed capacitors	NF C 83 100	CECC 30 000 EN 130 000	IEC 60 384 -1 QC 300 000
Sectional specification Electrolytic aluminum capacitors	NF C 83 110	CECC 30 300	IEC 60 384 - 4 C 300 300
Blank deta II specification - Electrolytic aluminum capacitors with non solid electrolyte.	UTE 83 110	CECC 30 301	IEC 60 384 - 4 -1 QC 300 301
Blank deta II specifications	CECC 30 301- 017 to CECC 30 301- 062 C0 31 to C0 55	CECC 30 301- 017 to CECC 30 301- 062 CECC 30 301- 802 to CECC 30 301- 811	

## 6. ENDURANCE TESTS / LIFE TIME

### 6.1. STANDARD ENDURANCE TEST

at max category temperature:

Standard endurance tests do not exceed 2000 hours at 125°C. However,

Temperature	Endurance test			
	Grade I - Long life			Grade II - General purpose
	10 000 h	5 000 h	2 000 h	1 000 h
125°C			•	
105°C		•	•	•
85°C	•	•	•	•

present EXXELIA technologies concerning liquid electrolytes have led to endurance tests up to 5000 hours at 125°C (PRORELSIC 125 - FELSIC 125 RS) and even 20000 hours at 125°C (PRORELSIC 145 - ALSIC 145)

### 6.2. PERFORMANCE REQUIREMENTS ON STANDARD ENDURANCE TESTS.

Permissible capacitance drift  $\Delta C/C$  (%)

Permissible increase factors on  $\tan\delta$ , ESR, Z and II initial values

(1)  $\tan\delta$  or ESR: for initial value, take standard value.

$U_R$	Endurance test			
	Grade I			Grade II
	10 000 h	5 000 h	2 000 h	1 000 h
6,3 V			+15 -30	+25 -40
10 V - 35 V	+15 -20	±15	±15	±30
40 V - 160 V	±15	±15	±15	±30
> 160 V	±15	±10	±10	±15

	Endurance test			
	Grade I			Grade II
	10 000 h	5 000 h	2 000 h	1 000 h
$\tan\delta$ or ESR [1]	1,5	1,3	1,3	1,5
Z [2]	3	2	2	3
II	Standard values			

[2] Z: for initial value, take specified value [see data sheet ].

Specific requirements can be taken into consideration with regards to initial values of dissipation factor or equivalent series resistance and impedance.

## 6.3. FAILURE CRITERIA FOR ELECTROLYTIC CAPACITORS.

Failure criteria are defined in CECC 30 301

- Non measurable defaults leading to complete failure.
- Measurable defaults leading to adjustment losses of the load circuit (failure due to variations).

### 6.3.1. Non measurable defaults.

They might be summed up as:

- Open circuit
- Short circuit
- Operation of pressure relief device
- Severely damaged insulation
- Unusable terminations

### 6.3.2. Measurable defaults.

Variations exceeding the values given below characterize a default.

- Capacitance drift  $\Delta C/C$  (%): 3 times the limit for standard endurance testing or 50 % (whichever is the smallest).
- $\tan\delta$  or ESR: 3 times standard max initial values.
- Z: 3 times standard max initial values.
- II: initial limit (under load conditions).

Specific requirements can be taken into consideration with regards to lower drifts.

## 6.4. INFLUENCE OF MAIN PARAMETER ON OPERATIONAL LIFE.

### 6.4.1. Temperature.

The capacitors operational life is highly dependent upon its internal temperature  $\Theta_i$  and therefore upon the ambient temperature and the ripple current.

Knowing ESR and dissipated power values (§ 6.4.3.) one can figure out, the internal temperature rise and then determine the capacitors expected life.

With present high boiling point electrolytes (§ 8.6)

$\Theta_i \text{ max} = 125 \text{ to } 185^\circ\text{C}$  depending on styles.

### 6.4.2. Ripple current.

The ripple current flowing through the capacitor increase the internal temperature through power dissipation.

Standards define the permissible current at 100 Hz and generally consider a temperature rise of 5 to 10°C of max category temperature.

Current waveforms and frequencies make it difficult to clearly determine the capacitors internal temperature rise, which defines the operationally life.

Experiments confirm following relationship:

$$\Theta_i = \Theta_a + (\Theta_c - \Theta_a) K$$

Where:

- $\Theta_i$  = Internal hot spot temperature
- $\Theta_a$  = Ambient temperature
- $\Theta_c$  = Case temperature
- K = Parameter depending upon case diameter and cooling
  - $\emptyset \geq 51 \text{ k} = 2 \pm 0,5$
  - $\emptyset < 51 \text{ k} = 1,5 \pm 0,5$  [air cooling - 0,2 m/s]



# General technical data

r.m.s. value according to current waveform.

one capacitor diameter

Function	Mean value	R.m.s. value	Function	Mean value	R.m.s. value	Function	Mean value	R.m.s. value
	$A (t_0/T)$	$A \sqrt{t_0/T}$		$A/2$	$A \sqrt{3}$		$2A/\pi$	$A/\sqrt{2}$
	$A (t_1/T)$	$A \sqrt{2t_1/3T}$		$2A/\pi (t_0/T)$	$A \sqrt{t_0/2T}$		$A/2$	$A/\sqrt{3}$
	$A/2 (t_0/T)$	$A \sqrt{t_0/3T}$		$A/2 (t_0/T)$	$A \sqrt{t_0/3T}$		0	A

### 6.4.3. Dissipated power versus case dimension

For calculations of ripple currents, considering an internal

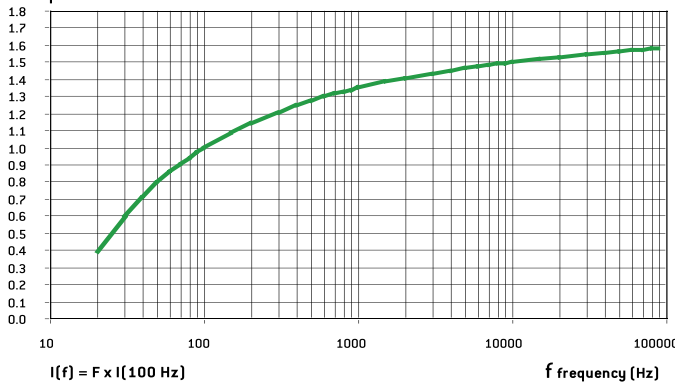
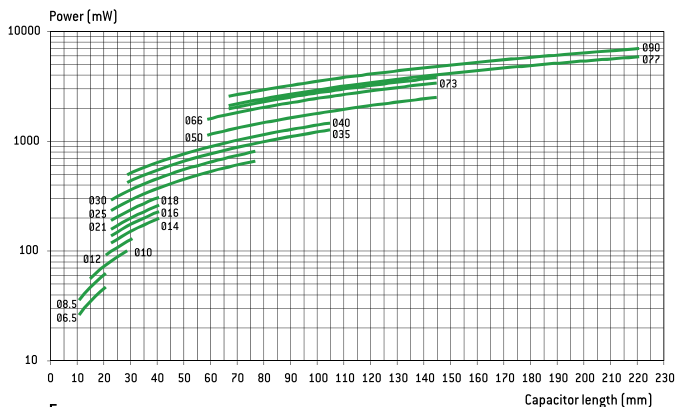

temperature rise of 10°C

$$P = ESR \cdot I^2$$

P = Dissipated power (mW)

( $\Theta_i - \Theta_a = 10^\circ\text{C}$ )

ESR: Equivalent series resistance (100 Hz 20°C)

I: Ripple current (r.m.s. value at 100 Hz)

For different frequencies from 100 Hz, I must be multiplied by the factor F, according to above chart.

### 6.4.4. Thermal resistance Rth and air cooling

Rth is static thermal resistance (without cooling) between capacitor central hot spot and ambient temperature measured at a distance of

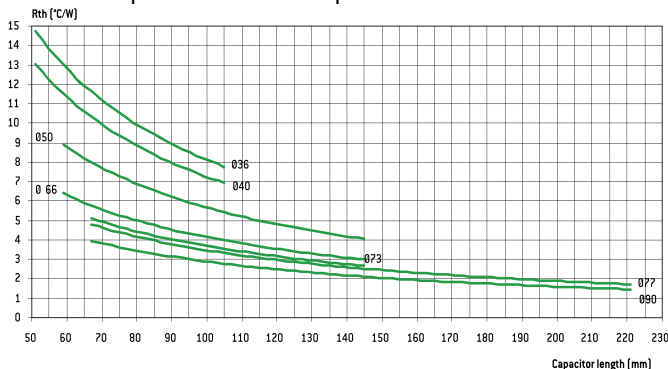

Forced or not cooling air can lead to a significant decrease of these values.

Consequently, r.m.s. ripple current can be increased as a function of air cooling speed:

Ø mm (inches)	≤ 0,5 m/s	1 m/s	2 m/s	3 m/s	≥ 4 m/s
66 - 90	1~	1,1~	1,2~	1,25~	1,3~
36 - 51	1~	1,2~	1,4~	1,45~	1,5~

This parameter shall be applied to one capacitor alone.

For capacitors in bank, ambient temperature must be strictly equal around all capacitors.

### 6.4.5. Quality guaranty

We guarantee products manufactured during 2 years from the data of shipment against defaults of material and assembly.

This guaranty can be involved by the buyer only if our products are used within normal conditions, always according to the state of the art and taking in account storage conditions.

The equipment design should take into consideration possible failures of our capacitors and related effects in order to avoid them.

Guaranty is not applicable for damages occurred by surge voltage, irregular use, polarity inversion or maintenance default.

Guaranty is exclusively limited to the replacement of individual defective capacitors within the terms of delivery. This rule applied to all cases and particularly to any further consequence of failures.

### 6.4.6. Reliability

Failure rate: \_\_\_\_\_

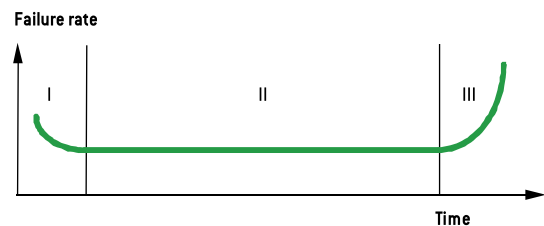

$$FR = \frac{\text{Number of components tested} \times \text{test duration}}{\text{Number of failures}}$$

Failure rate is measured in FIT (failure in time =  $10^{-9}$  / hour).

The failure rate is set up during the life time of the capacitor (phase II)

I. Early failure phase (generally excluded during ageing process).

II. Operational life time of the capacitors

III. End of life

# General technical data

Mean time between failures MTBF = 1/FR mesured in years

Range	Failure rate for a failure percentage not exceeding 1% with a confidence level of 60 %
FELSIC 85 >350 V FELSIC HC > 350 V SNAPSIC - SNAPSIC HC > 350 V SNAPSIC 4P > 350 V PROMISIC 031 Ø = 6,5 SICAL CO 42 - SICAL > 350 V	50 FIT - (MTBF = 2280)
FELSIC 037 - 039 FELSIC 85 ≤ 350 V FELSIC HC ≤ 350 V CUBISIC CI FRS SNAPSIC 105 - SNAPSIC 105 4P SNAPSIC 105 LP - SNAPSIC HV SNAPSIC - SNAPSIC 4P ≤ 350 V SNAPSIC HC ≤ 350 V ALSIC IR - ALSIC 145 - ALSIC HV - VACSIC 150 - VACSIC SICAL CO 42 - SICAL ≤ 350 V PRORELSIC 125 Ø = 6,5 RELSIC 033 PROMISIC 031 Ø > 6,5	25 FIT - (MTBF = 4560)
FELSIC 125 FRS - SNAPSIC 125 FELSIC HV - FELSIC 105	10 FIT - (MTBF = 11410)
PRORELSIC 125 Ø > 6,5 PRORELSIC 145	5 FIT - (MTBF = 22820)

Multiplying factor of FR with voltage and temperature

	Temperature (°C)							
	≤ 40	50	60	70	85	105 (1)	125 (1)	145 (1)
Factor	1	1,5	2,3	3,4	6,3	14	32	72

(1) Only for permitted capacitors

	Percentage of rated voltage (2)		
	100 %	80 %	50 %
Factor	1	0,8	0,5

(2) This voltage has to be constant

Environ- ment	Without vibration		Ground with vibrations or mob Ile			
	Ground, fix Controlled air	Ground, fix	PRORELSIC SNAPSIC 20 g FELSIC 20 g	FELSIC 10 g PROMISIC SICAL Ø ≤14	CI FRS - SNAPSIC RELSIC SICAL Ø >14	ALSIC
Factor	1	2	2	4	6	12

## 7. MANUFACTURING FLOW CHART

Process controls

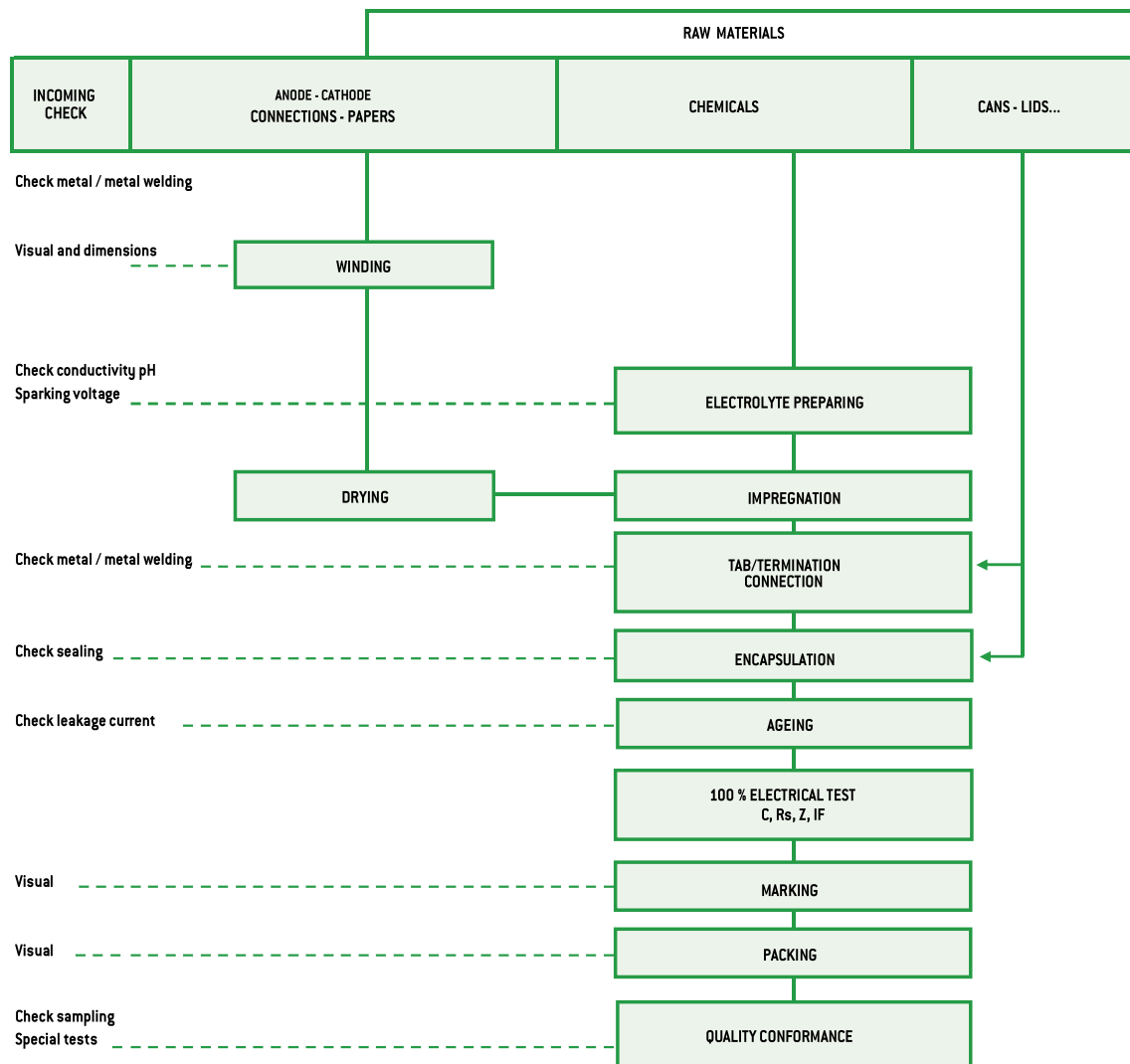

# General technical data

Ring - clip mounting: FELSIC BC

Ring clips shall be ordered separately.

Tightening screws and nuts are supplied loosely.

## FELSIC BC - Metal ring-clips

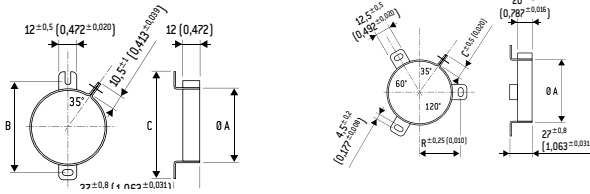

Ø A Cap.	B	C	Code	Ø A Cap.	B	C	Code
36	54	63	A 691901	51	33,5	11,8	A 691905
				66	39	10,5	A 691913
				73	44	10,5	A 691914
				77	44,5	10,5	A 691907
				90	53,3	11,8	A 691915

Stirrup mounting: CUBISIC LP

Stirrups shall be ordered separately.

Tightening screws and nuts are supplied loosely

Salt mist endurance of screws and mounting accessories:  
minimum 96 h (IEC 600 68-2-11)

## CUBISIC /CUBISIC LP - Metal bracket

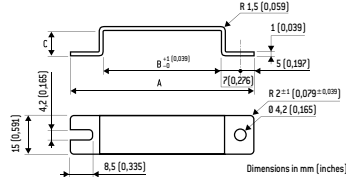

Ø A Cap.	A	B	C	Code
45x12 (1,772x0,472)	69 (2,717)	45 (1,772)	10 (0,394)	A 691057
35x16 (1,378x0,630)	59 (2,323)	35 (1,378)	14 (0,551)	A 691059

## PACKAGING

### 1. PACKAGING AND WEIGHT UNITS.

#### 1.1. Capacitor with screw terminals

Can DIMENSIONS in mm (inches)				Unit weight *
Ø	H			(g)
36 (1,417)	47 (1,850)	52 (2,047)	53 (2,087)	70
36 (1,417)	60 (2,362)			79
36 (1,417)	80 (3,150)	81 (3,189)		100
36 (1,417)	104 (4,094)	105 (4,134)		120
51 (2,008)	47 (1,850)			80
51 (2,008)	62 (2,441)	63 (2,480)		105
51 (2,008)	81 (3,189)	82 (3,228)		190
51 (2,008)	104 (4,094)	105 (4,134)		260
51 (2,008)	112 (4,409)			270
51 (2,008)	144 (5,669)			370
66 (2,598)	104 (4,094)	105 (4,134)		430
66 (2,598)	112 (4,409)			460
73 (2,874)	104 (4,094)	112 (4,409)		600
73 (2,874)	144 (5,669)			680
77 (3,031)	104 (4,094)	105 (4,134)		620
77 (3,031)	144 (5,669)	145 (5,709)		860
77 (3,031)	200 (7,874)			1300
77 (3,031)	220 (7,874)	221 (8,701)		1400
90 (3,543)	67 (2,638)			600
90 (3,543)	144 (5,669)	145 (5,709)		1400
90 (3,543)	200 (7,874)			1800

\* Unit weight = typical values

Possible variations of = ± 25 % according to different voltage and capacitance.

#### 1.2. Radial solder types

Can dimensions mm (inches)			ALSIC	SNAP-SIC	Can dimensions		AL-SIC	SNAP-SIC
Ø	H	Weight* (g)			Ø	H	Weight* (g)	
10 (0,394)	16 (0,630)	1,8	-		35 (1,378)	30 (1,181)	-	50
12,5 (0,492)	21 (0,827)	4,5	-		35 (1,378)	40 (1,575)	-	50
12,5 (0,492)	24 (0,945)	5	-		35 (1,378)	45 (1,772)	-	52
					35 (1,378)	50 (1,969)	-	60
16 (0,630)	25 (0,984)	8,2	-		35 (1,378)	75 (2,953)	-	95
					35 (1,378)	100 (3,937)	-	125
22 (0,866)	25 (0,984)	-	15		40 (1,575)	40 (1,575)	-	65
22 (0,866)	30 (1,181)	-	17		40 (1,575)	50 (1,969)	-	100
22 (0,866)	40 (1,575)	-	18		40 (1,575)	75 (2,953)	-	130
					40 (1,575)	100 (3,937)	-	170
25 (0,984)	25 (0,984)	-	17		45 (1,772)	21 (0,827)	-	50
25 (0,984)	30 (1,181)	-	20		45 (1,772)	0,984	-	60
25 (0,984)	35 (1,378)	-	22		45 (1,772)	30 (1,181)	-	73
25 (0,984)	40 (1,575)	-	25		45 (1,772)	35 (1,378)	-	85
25 (0,984)	45 (1,772)	-	28		45 (1,772)	45 (1,772)	-	110
25 (0,984)	50 (1,969)	-	30		45 (1,772)	75 (2,953)	-	180
					45 (1,772)	100 (3,937)	-	240
30 (1,181)	25 (0,984)	-	28					
30 (1,181)	30 (1,181)	-	30					
30 (1,181)	35 (1,378)	-	30					
30 (1,181)	40 (1,575)	-	40					
30 (1,181)	45 (1,772)	-	45					
30 (1,181)	50 (1,969)	-	50					

Can DIMENSIONS in mm (inches)			CUBISIC
I	L	H	weight (g)
35 (1,378)	35 (1,378)	16 (0,630)	30
35 (1,378)	50 (1,969)	16 (0,630)	40
45 (1,772)	35 (1,378)	12 (0,472)	30
45 (1,772)	50 (1,969)	12 (0,472)	45
45 (1,772)	75 (2,953)	12 (0,472)	60

\* Unit weight = typical values

Possible variations of = ± 25 % according to different voltage and capacitance.

#### 1.3. Axial types

Can DIMENSIONS in mm (inches)		PRORELSIC RELSIC	PRORELSIC PROMISIC	SICAL CO 42 SICAL
Ø	H	Unit weight * (g)	Unit weight * (g)	Unit weight * (g)
6,5 (0,256)	15 (0,591)	-	1,6	-
6,5 (0,256)	19 (0,748)	-	1,8	1,8
8,5 (0,335)	19 (0,748)	-	2,3	2,3
10 (0,394)	19 (0,748)	-	2,8	2,8
10 (0,394)	25 (0,984)	-	3,5	3,5
10 (0,394)	28 (1,102)	-	3,8	-
12 (0,472)	25 (0,984)	-	5	-
12 (0,472)	30 (1,181)	-	5,4	5,4
14 (0,551)	30 (1,181)	-	6,9	6,9
14 (0,551)	41 (1,614)	-	9,5	-
	30 (1,181)	7,7	-	7,7
18 (0,709)	35 (1,378)	13,6	-	-
18 (0,709)	40 (1,575)	15,3	-	15,3
21 (0,827)	40 (1,575)	19,5	-	19,5
25 (0,984)	40 (1,575)	28	-	28
25 (0,984)	50 (1,969)	35	-	35
25 (0,984)	75 (2,953)	56	-	56

\* Unit weight = typical values

Possible variations of = ± 25 % according to different voltage and capacitance.

# General technical data

## 2. PACKAGING ON TAPE

### 2.1. Axial types

Dimensions and tolerance in accordance with IEC 60 286-

(1) On tape only on request

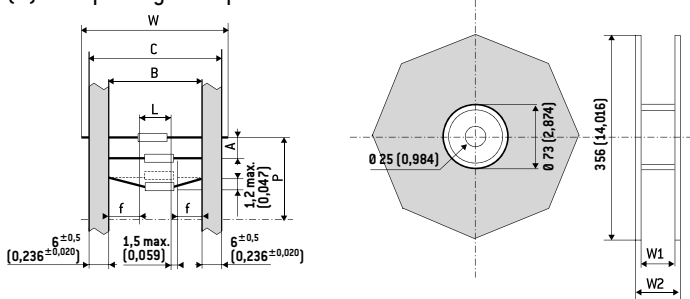

DIMENSIONS in mm (inches)									
D	L max.	B	A	P	C max.	W <sub>1</sub>	W <sub>2</sub> max.	W	n <sup>(2)</sup>
6,5 (0,256)	20 (0,787)	73 <sup>±1,5</sup>	10 <sup>±1,5</sup>	± 2 (0,079)	87,5 (3,445)	93 (3,661)	106 (3,661)	85 <sup>±1,5</sup>	1000 (39,370)
8,5 (0,335) <sup>(1)</sup>		(2,874 <sup>±0,059</sup> )	(0,394 <sup>±0,059</sup> )					(3,346 <sup>±0,059</sup> )	750 (29,528)
10 (0,394) <sup>(1)</sup>	32 (1,260)	73 <sup>±1,5</sup>	15 <sup>±1,5</sup>	± 3 (0,118)	87,5 (3,445)	93 (3,661)	106 (3,661)	85 <sup>±1,5</sup>	400 (15,748)
12 (0,472) <sup>(1)</sup>		(2,874 <sup>±0,059</sup> )	(0,591 <sup>±0,059</sup> )					(3,346 <sup>±0,059</sup> )	400 (15,748)
14 (0,551) <sup>(1)</sup>									200 (7,874)

(2) n = number of capacitors per reel.

White positive tape f: > 20 mm (0,787 inches)

P: 10 space

# SCREW TERMINALS

SCREW TERMINALS



EXXELIA



# FELSIC 85

CO 54 - CO 53

15 000 h / 85°C

10 V ... 630 V	68 µF ... 680 000 µF	Ø 36 [1,417] ... Ø 90 [3,543]	- 55°C + 85°C	Long Life Time
----------------	----------------------	-------------------------------	---------------	----------------



## APPLICATIONS

- Power electronics: converters, current inverters
- Switch mode power supplies
- Magnetization, welding machines, flash
- Circuit with high impulse current
- 360 V and 480 V series are mainly designed for repetitive fast discharges working.

Fixing: Clip or stud fixing  
Screw terminals: M5 or M6

Tolerance on capacitance at 20°C : -10 +30 %  
Operating temperature: - 55°C + 85°C

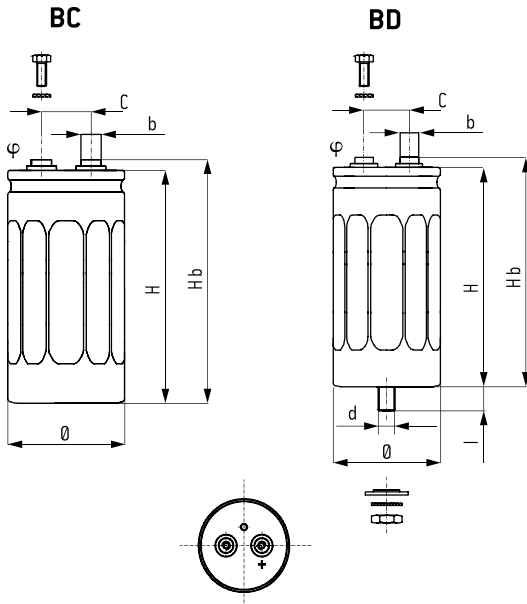

BC	BD
Insulated aluminum can	Aluminum can with sleeve
Hexagonal screws	Hexagonal screws
Spring washers	Spring washers
Fixing clip must be ordered separately	Stud fixing delivered with capacitor (steel hex nut, spring washer)

## DIMENSIONS in mm (inches)

Ø ±1 (0,039)	H ±2 (0,079)	Hb ±2 (0,079)	C ±0,5 (0,020)	Φ	b
36 [1,417]	52 [2,047]	58 [2,283]	12,7 [0,500]	M5	8 [0,315]
36 [1,417]	60 [2,362]	66 [2,598]	12,7 [0,500]	M5	8 [0,315]
36 [1,417]	80 [3,150]	86 [3,386]	12,7 [0,500]	M5	8 [0,315]
36 [1,417]	104 [4,094]	110 [4,331]	12,7 [0,500]	M5	8 [0,315]
51 [2,008]	81 [3,189]	87 [3,425]	22,2 [0,874]	M5	13 [0,512]
51 [2,008]	104 [4,094]	110 [4,331]	22,2 [0,874]	M5	13 [0,512]
66 [2,598]	104 [4,094]	110 [4,331]	28,5 [1,122]	M5	13 [0,512]
77 [3,031]	104 [4,094]	110 [4,331]	31,7 [1,248]	M5	13 [0,512]
77 [3,031]	144 [5,669]	150 [5,906]	31,7 [1,248]	M5	13 [0,512]
77 [3,031]	220 [8,661]	226 [8,898]	31,7 [1,248]	M5	13 [0,512]
90 [3,543]	144 [5,669]	151 [5,945]	31,7 [1,248]	M6	13 [0,512]
90 [3,543]	200 [7,874]	207 [8,150]	31,7 [1,248]	M6	13 [0,512]

Ø	d	l	Max. nut torque
36 [1,417]	M8	12±1 [0,472±0,472]	4 Nm
≥ 51 [2,008]	M12	16±1,5 [0,630±0,059]	10 Nm

## HEXAGONAL SCREWS mm (inches)

Screwing height between screws and terminals:  
3,5 [0,138] max

Max. screw torque: M5: 3 Nm [x min 8 [0,315]]  
M6: 6 Nm [x min 10 [0,394]]

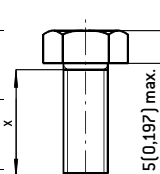

## RESISTANCE TO VIBRATIONS

Hb mm (inches)	>150 [5,906]	≤150 [5,906]
f (Hz)	10 - 55 Hz	10 - 2000 Hz
Amplitude	0,75 [0,030]	1,5 [0,059]
Acceleration	10 g - 98 m/s²	20 g - 196 m/s²
t (h)	3 x 2 h	3 x 2 h

## SPECIFICATIONS

NFC 83 110 - Long life  
DIN 41 240 - Climatic category GPF - 55°C + 85°C / 56 days  
CECC 30301-059 Issue 3  
CECC 30 301-810  
IEC 60 384.4 long life  
Standard endurance test at U<sub>R</sub>: U<sub>R</sub> ≤ 350 V: 5000 h / 85°C  
U<sub>R</sub> > 350 V: 2000 h / 85°C

## WITHSTAND STRENGTH OF INSULATING SLEEVE

Insulation resistance at 20°C between terminals and mounting hardware: 100 MΩ  
Test voltage at 50 Hz 1 min. between terminals and mounting hardware: 2000 V  
Fire resistance: self extinguish 15 s (IEC 60 695-2-2)

15 000 h / 85°C

Capacitance [μF]	Can		ESR 100 Hz +20°C		Z 10 kHz +20°C max. [mΩ]	I +20°C 5 min max. [mA]	I <sub>r</sub> 100 Hz		Code			
	Ø mm (inches)	H mm (inches)	Typic [mΩ]	max. [mΩ]			+40°C max. [A]	+85°C [A]	CO 54 [BC]	CO 53 [BD]		
<b>Rated voltage 10 V</b>												
33000	36	(1,417)	52	(2,047)	16	24	25	1,8	22	6,6	A 744020	A 745020
68000	36	(1,417)	104	(4,094)	7	11	13	4	22	13,5	A 744021	A 745021
330000	66	(2,598)	104	(4,094)	4	8	7	5	50	25	A 744023	A 745023
<b>Rated voltage 16 V</b>												
22000	36	(1,417)	52	(2,047)	16	24	25	2	22	6,6	A 744040	A 745040
47000	36	(1,417)	80	(3,150)	11	16	15	4	22	8,8	A 744041	A 745041
100000	51	(2,008)	81	(3,189)	8	12	10	5	25	13,7	A 744042	A 745042
150000	51	(2,008)	104	(4,094)	7	11	8	5	25	16,4	A 744043	A 745043
220000	66	(2,598)	104	(4,094)	5	8	6	5	50	22,3	A 744044	A 745044
330000	77	(3,031)	104	(4,094)	3	5	6	6	55	31,5	A 744045	A 745045
470000	77	(3,031)	144	(5,669)	3	5	6	6	55	36	A 744046	A 745046
680000	77	(3,031)	220	(8,661)	3	5	6	7	55	43	A 744047	A 745047
<b>Rated voltage 25 V</b>												
15000	36	(1,417)	52	(2,047)	18	27	26	2	22	6,2	A 744060	A 745060
22000	36	(1,417)	52	(2,047)	17	25	24	3	22	6,5	A 744069	A 745069
33000	36	(1,417)	80	(3,150)	15	23	18	4	22	8,2	A 744061	A 745061
47000	36	(1,417)	104	(4,094)	12	18	15	5	25	10,3	A 744070	A 745070
47000	51	(2,008)	81	(3,189)	9	14	10	5	25	12,9	A 744062	A 745062
68000	51	(2,008)	81	(3,189)	8	14	10	5	25	13,7	A 744063	A 745063
100000	51	(2,008)	104	(4,094)	8	14	8	5	25	15,3	A 744064	A 745064
150000	66	(2,598)	104	(4,094)	7	11	7	5	50	18,9	A 744065	A 745065
220000	77	(3,031)	104	(4,094)	4	6	7	6	55	26	A 744066	A 745066
330000	77	(3,031)	144	(5,669)	3	5	6	7	55	36	A 744067	A 745067
<b>Rated voltage 40 V</b>												
10000	36	(1,417)	52	(2,047)	20	30	28	2	21	5,9	A 744080	A 745080
15000	36	(1,417)	80	(3,150)	18	27	23	3	22	7,5	A 744081	A 745081
22000	36	(1,417)	104	(4,094)	15	22	19	5	22	9,2	A 744082	A 745082
33000	51	(2,008)	81	(3,189)	10	15	13	5	25	12	A 744091	A 745091
47000	51	(2,008)	81	(3,189)	9	14	9	5	25	12,9	A 744083	A 745083
68000	51	(2,008)	104	(4,094)	8	12	8	6	25	14,4	A 744092	A 745092
100000	66	(2,598)	104	(4,094)	7	11	7	6	50	18,9	A 744084	A 745084
150000	77	(3,031)	104	(4,094)	5	8	7	8	55	24,5	A 744085	A 745085
220000	77	(3,031)	144	(5,669)	4	6	6	9	55	31,5	A 744086	A 745086
470000	90	(3,543)	200	(7,874)	3	5	5	15	80	46	A 744088	A 745088
<b>Rated voltage 63 V</b>												
4700	36	(1,417)	52	(2,047)	40	60	48	1,6	15	4,2	A 744100	A 745100
6800	36	(1,417)	52	(2,047)	35	50	39	2,5	15	4,4	A 744112	A 745112
10000	36	(1,417)	80	(3,150)	23	34	28	3	22	7	A 744101	A 745101
15000	51	(2,008)	81	(3,189)	13	20	18	5	25	10,7	A 744102	A 745102
22000	51	(2,008)	81	(3,189)	12	18	15	5	25	11,1	A 744103	A 745103
33000	51	(2,008)	104	(4,094)	10	15	14	5	25	13,7	A 744113	A 745113
33000	66	(2,598)	104	(4,094)	10	15	14	5	50	15,8	A 744104	A 745104
47000	66	(2,598)	104	(4,094)	8	12	11	6	50	17,7	A 744105	A 745105
68000	77	(3,031)	104	(4,094)	5	8	8	8	55	24,5	A 744106	A 745106
100000	77	(3,031)	144	(5,669)	3	8	8	9	55	36	A 744107	A 745107
150000	77	(3,031)	220	(8,661)	3	8	8	11	55	43	A 744109	A 745109
220000	90	(3,543)	200	(7,874)	3	5	4	15	80	46	A 744110	A 745110
<b>Rated voltage 80 V</b>												
3300	36	(1,417)	52	(2,047)	60	90	70	1,5	12	3,4	A 744360	A 745360
10000	51	(2,008)	81	(3,189)	19	29	23	5	25	8,9	A 744363	A 745363
15000	51	(2,008)	81	(3,189)	17	25	20	5	25	9,4	A 744364	A 745364
22000	51	(2,008)	104	(4,094)	14	21	17	6	25	12	A 744365	A 745365
33000	66	(2,598)	104	(4,094)	12	18	15	6	49	14	A 744366	A 745366
47000	77	(3,031)	104	(4,094)	8	12	10	8	55	19	A 744367	A 745367
68000	77	(3,031)	144	(5,669)	6	9	8	9	55	26	A 744368	A 745368
<b>Rated voltage 100 V</b>												
2200	36	(1,417)	52	(2,047)	70	105	90	1,1	11	3,1	A 744120	A 745120
4700	36	(1,417)	80	(3,150)	45	68	54	2,5	16	4,7	A 744121	A 745121
6800	51	(2,008)	81	(3,189)	24	36	27	4	25	7,9	A 744122	A 745122
10000	51	(2,008)	81	(3,189)	20	30	21	5	25	8,7	A 744123	A 745123
15000	51	(2,008)	104	(4,094)	17	26	18	6	25	10,5	A 744124	A 745124
22000	66	(2,598)	104	(4,094)	13	19	15	6	49	13,9	A 744125	A 745125
33000	77	(3,031)	104	(4,094)	10	15	13	8	55	17,5	A 744126	A 745126
47000	77	(3,031)	144	(5,669)	7	11	10	9	55	23	A 744127	A 745127
100000	90	(3,543)	200	(7,874)	5	8	6	11	80	35	A 744130	A 745130

## FELSIC 85

CO 54 - CO 53

15 000 h / 85°C

Capacitance ( $\mu$ F)	Can		ESR 100 Hz +20°C		Z 10 kHz +20°C max. (m $\Omega$ )	II +20°C 5 min max. (mA)	I $\sim$ 100 Hz		Code			
	$\emptyset$ mm (inches)	H mm (inches)	Typic (m $\Omega$ )	max. (m $\Omega$ )			+40°C max. (A)	+85°C (A)	CO 54 (BC)	CO 53 (BD)		
<b>Rated voltage 160 V</b>												
1000	36	(1,417)	52	(2,047)	85	130	80	0,9	10	2,8	A 744140	A 745140
1500	36	(1,417)	80	(3,150)	55	85	70	1,3	15	4,3	A 744141	A 745141
2200	36	(1,417)	104	(4,094)	48	73	53	2	18	5,2	A 744142	A 745142
3300	51	(2,008)	81	(3,189)	28	42	34	3	25	7,3	A 744143	A 745143
4700	51	(2,008)	104	(4,094)	20	30	28	4	25	9,7	A 744144	A 745144
6800	66	(2,598)	104	(4,094)	17	25	21	5	43	12,3	A 744145	A 745145
10000	77	(3,031)	104	(4,094)	12	18	16	6	55	15,8	A 744146	A 745146
15000	77	(3,031)	144	(5,669)	10	14	13	8	55	20	A 744147	A 745147
22000	77	(3,031)	220	(8,661)	10	15	13	10	55	24	A 744148	A 745148
33000	90	(3,543)	200	(7,874)	8	12	11	14	80	28	A 744150	A 745150
<b>Rated voltage 250 V</b>												
470	36	(1,417)	52	(2,047)	110	170	100	0,7	9	2,5	A 744160	A 745160
1000	36	(1,417)	80	(3,150)	70	105	70	1,5	13	3,8	A 744161	A 745161
1500	51	(2,008)	81	(3,189)	50	75	50	2	19	5,5	A 744162	A 745162
2200	51	(2,008)	81	(3,189)	48	72	48	3	20	5,6	A 744163	A 745163
3300	51	(2,008)	104	(4,094)	35	50	35	4	25	7,6	A 744164	A 745164
4700	66	(2,598)	104	(4,094)	21	32	20	6	38	10,9	A 744165	A 745165
6800	77	(3,031)	104	(4,094)	16	24	15	8	46	13	A 744166	A 745166
10000	77	(3,031)	144	(5,669)	14	21	13	9	55	16,8	A 744167	A 745167
15000	77	(3,031)	220	(8,661)	12	18	12	10	55	22	A 744168	A 745168
22000	90	(3,543)	200	(7,874)	10	15	12	14	80	25	A 744170	A 745170
<b>Rated voltage 350 V</b>												
330	36	(1,417)	52	(2,047)	240	360	190	0,7	5,9	1,7	A 744180	A 745180
470	36	(1,417)	80	(3,150)	150	230	140	0,9	9	2,6	A 744181	A 745181
680	36	(1,417)	104	(4,094)	100	150	100	1,4	13	3,6	A 744182	A 745182
1000	51	(2,008)	81	(3,189)	75	110	65	2	16	4,5	A 744183	A 745183
1500	51	(2,008)	104	(4,094)	55	75	55	3	20	5,8	A 744184	A 745184
2200	66	(2,598)	104	(4,094)	30	45	32	4	32	9,1	A 744185	A 745185
3300	77	(3,031)	104	(4,094)	25	38	27	6	38	10,9	A 744186	A 745186
4700	77	(3,031)	104	(4,094)	20	30	18	7	43	12,2	A 744191	A 745191
6800	77	(3,031)	144	(5,669)	17	25	15	7	53	15,2	A 744187	A 745187
8200	77	(3,031)	220	(8,661)	12	18	15	8	55	22	A 744188	A 745188
10000	77	(3,031)	220	(8,661)	11	16	14	9	55	23	A 744189	A 745189
15000	90	(3,543)	200	(7,874)	10	15	13	14	80	25	A 744190	A 745190
<b>Rated voltage 360 V</b>												
910	36	(1,417)	80	(3,150)	160	200	130	3,4	9,8	2,8	A 744341	A 745341
1200	36	(1,417)	104	(4,094)	120	180	120	3,9	11	3,3	A 744342	A 745342
4700	66	(2,598)	104	(4,094)	80	120	80	7	20	5,6	A 744345	A 745345
10000	77	(3,031)	144	(5,669)	35	50	35	10	39	11	A 744347	A 745347
20000	90	(3,543)	200	(7,874)	9	14	12	16	80	26	A 744349	A 745349
<b>Rated voltage 385 V</b>												
220	36	(1,417)	52	(2,047)	380	570	360	0,5	4,6	1,3	A 744200	A 745200
1000	51	(2,008)	81	(3,189)	90	135	100	2,3	14	4,1	A 744202	A 745202
1500	51	(2,008)	104	(4,094)	70	110	80	3,4	18	5	A 744203	A 745203
2200	66	(2,598)	104	(4,094)	50	75	50	5	25	7,1	A 744204	A 745204
3300	77	(3,031)	104	(4,094)	29	45	30	6	35	10,1	A 744205	A 745205
4700	77	(3,031)	144	(5,669)	22	35	25	7	47	13,4	A 744206	A 745206
6800	77	(3,031)	220	(8,661)	17	25	15	8	55	18,4	A 744207	A 745207
<b>Rated voltage 400 V</b>												
220	36	(1,417)	52	(2,047)	400	600	500	1,7	4,6	1,3	A 744220	A 745220
330	36	(1,417)	80	(3,150)	280	420	300	2,0	6,6	1,9	A 744221	A 745221
470	36	(1,417)	104	(4,094)	200	300	200	2,5	9	2,5	A 744222	A 745222
1000	51	(2,008)	81	(3,189)	90	135	100	3,5	14	4,1	A 744223	A 745223
1500	66	(2,598)	104	(4,094)	60	90	60	4,0	22	6,4	A 744224	A 745224
2200	66	(2,598)	104	(4,094)	40	70	50	5,0	28	7,9	A 744225	A 745225
3300	77	(3,031)	104	(4,094)	29	50	35	6,0	35	10,1	A 744226	A 745226
4700	77	(3,031)	144	(5,669)	22	35	25	7,0	47	13,4	A 744227	A 745227
6800	90	(3,543)	144	(5,669)	16	25	15	9,0	64	18,4	A 744229	A 745229
10000	90	(3,543)	200	(7,874)	11	18	15	12,0	80	24,0	A 744230	A 745230



15 000 h / 85°C

Capacitance [μF]	Can		ESR 100 Hz +20°C		Z 10 kHz +20°C max. [mΩ]	II +20°C 5 min max. [mA]	I~ 100 Hz		Code			
	Ø mm (inches)	H mm (inches)	Typic [mΩ]	max. [mΩ]			+40°C max. [A]	+85°C [A]	CO 54 [BC]	CO 53 [BD]		
<b>Rated voltage 450 V</b>												
150	36	(1,417)	52	(2,047)	590	890	700	1,5	3,9	1,1	A 744240	A 745240
220	36	(1,417)	60	(2,362)	400	600	480	1,8	4,9	1,4	A 744241	A 745241
330	36	(1,417)	80	(3,150)	260	400	370	2,3	7	2,0	A 744242	A 745242
470	36	(1,417)	104	(4,094)	170	260	240	2,7	9,5	2,7	A 744243	A 745243
680	51	(2,008)	81	(3,189)	130	190	130	3,3	12	3,3	A 744244	A 745244
1000	51	(2,008)	104	(4,094)	85	130	90	4,0	16	4,7	A 744245	A 745245
1500	66	(2,598)	104	(4,094)	65	100	85	5,0	22	6,2	A 744246	A 745246
2200	66	(2,598)	104	(4,094)	50	85	70	6,0	25	7,0	A 744250	A 745250
2200	77	(3,031)	104	(4,094)	38	70	60	6,0	31	8,8	A 744247	A 745247
3300	77	(3,031)	144	(5,669)	25	50	40	7,3	44	12,6	A 744248	A 745248
4700	77	(3,031)	144	(5,669)	22	40	35	8,7	47	13,4	A 744252	A 745252
5600	77	(3,031)	220	(8,661)	20	40	30	9,5	55	17,0	A 744249	A 745249
6000	90	(3,543)	144	(5,669)	20	40	30	9,9	60	17,0	A 744253	A 745253
6800	90	(3,543)	200	(7,874)	15	30	20	10,0	72	20,0	A 744251	A 745251
8000	90	(3,543)	200	(7,874)	12	20	18	11,0	80	23,0	A 744255	A 745255
10000	90	(3,543)	200	(7,874)	11	18	16	13,0	80	24,0	A 744256	A 745256
<b>Rated voltage 480 V</b>												
150	36	(1,417)	52	(2,047)	550	820	600	1,6	3,9	1,1	A 744260	A 745260
220	36	(1,417)	60	(2,362)	450	680	500	2,0	4,6	1,3	A 744261	A 745261
330	36	(1,417)	80	(3,150)	290	440	400	2,4	6,7	1,9	A 744262	A 745262
470	36	(1,417)	104	(4,094)	200	300	300	2,9	8,8	2,5	A 744263	A 745263
680	51	(2,008)	81	(3,189)	150	220	150	3,8	11	3,2	A 744264	A 745264
1000	51	(2,008)	104	(4,094)	100	150	100	4,2	15	4,3	A 744265	A 745265
1500	66	(2,598)	104	(4,094)	65	100	85	5,0	22	6,2	A 744266	A 745266
2200	77	(3,031)	104	(4,094)	38	70	60	6,2	31	8,8	A 744267	A 745267
3300	77	(3,031)	144	(5,669)	25	50	40	7,5	44	12,6	A 744268	A 745268
4700	77	(3,031)	220	(8,661)	20	30	20	9,0	55	17,0	A 744269	A 745269
6800	90	(3,543)	200	(7,874)	15	25	15	11,0	74	21,0	A 744270	A 745270
<b>Rated voltage 500 V</b>												
68	36	(1,417)	52	(2,047)	700	1050	750	1,1	3,5	1,0	A 744280	A 745280
100	36	(1,417)	52	(2,047)	520	800	550	1,3	4	1,2	A 744381	A 745381
150	36	(1,417)	60	(2,362)	400	700	500	1,6	4,9	1,4	A 744382	A 745382
220	36	(1,417)	80	(3,150)	280	420	300	2,0	6,6	1,9	A 744383	A 745383
330	36	(1,417)	104	(4,094)	240	360	260	2,4	8	2,3	A 744384	A 745384
470	51	(2,008)	81	(3,189)	170	260	180	2,9	10	3,0	A 744385	A 745385
680	51	(2,008)	104	(4,094)	120	180	130	3,5	14	3,9	A 744386	A 745386
1000	66	(2,598)	104	(4,094)	80	120	80	4,2	20	5,6	A 744387	A 745387
1500	77	(3,031)	104	(4,094)	70	105	70	5,2	23	6,5	A 744388	A 745388
2200	77	(3,031)	144	(5,669)	50	75	50	6,2	31	8,9	A 744389	A 745389
3300	77	(3,031)	220	(8,661)	30	45	35	7,7	49	14,0	A 744390	A 745390
4700	90	(3,543)	200	(7,874)	20	35	25	9,2	62	18,0	A 744391	A 745391
<b>Rated voltage 550 V</b>												
68	36	(1,417)	52	(2,047)	850	1300	900	1,5	3,2	0,9	A 744302	A 745302
100	36	(1,417)	52	(2,047)	600	1000	700	1,9	3,8	1,1	A 744303	A 745303
150	36	(1,417)	80	(3,150)	500	800	600	2,3	5	1,4	A 744304	A 745304
220	36	(1,417)	104	(4,094)	400	600	450	2,8	6,3	1,8	A 744305	A 745305
330	51	(2,008)	81	(3,189)	300	450	330	3,4	7,8	2,2	A 744306	A 745306
470	51	(2,008)	104	(4,094)	200	300	230	4,1	11	3,1	A 744307	A 745307
680	66	(2,598)	104	(4,094)	130	200	150	4,9	15	4,4	A 744308	A 745308
1000	77	(3,031)	104	(4,094)	100	150	110	5,9	19	5,5	A 744309	A 745309
1500	77	(3,031)	144	(5,669)	80	120	80	7,3	25	7,0	A 744310	A 745310
2200	90	(3,543)	144	(5,669)	40	70	55	8,8	38	11,0	A 744311	A 745311
3300	90	(3,543)	200	(7,874)	25	45	35	11,0	56	16,0	A 744301	A 745301
4700	90	(3,543)	200	(7,874)	20	35	30	13,0	62	18,0	A 744313	A 745313
<b>Rated voltage 630 V</b>												
68	36	(1,417)	52	(2,047)	2400	3600	3000	2,0	1,9	0,5	A 744400	A 745400
100	36	(1,417)	52	(2,047)	2000	3000	2800	2,5	2,1	0,6	A 744411	A 745411
150	36	(1,417)	80	(3,150)	1100	1650	1200	3,1	3,3	1,0	A 744401	A 745401
220	36	(1,417)	104	(4,094)	750	1150	850	3,7	4,6	1,3	A 744402	A 745402
330	51	(2,008)	81	(3,189)	500	750	550	4,6	6	1,7	A 744403	A 745403
470	51	(2,008)	104	(4,094)	350	520	400	5,4	8	2,3	A 744404	A 745404
680	66	(2,598)	104	(4,094)	230	350	270	6,5	12	3,3	A 744405	A 745405
1000	77	(3,031)	104	(4,094)	200	300	250	7,9	14	3,9	A 744406	A 745406
1500	77	(3,031)	144	(5,669)	180	270	200	9,7	16	4,7	A 744407	A 745407
2200	90	(3,543)	144	(5,669)	120	180	120	12,0	22	6,3	A 744408	A 745408
3300	90	(3,543)	200	(7,874)	80	120	80	15,0	31	8,9	A 744409	A 745409

# FELSIC 85

**CO 54 - CO 53****15 000 h / 85°C**

## PEAK VOLTAGE (V)

1000 cycles, without ripple current

Up: Repetitive standard peak voltage (30 s)

Us: Repetitive surge voltage (0,1 s)

Do not overstep this value without damage.

U <sub>R</sub>	10 V	16 V	25 V	40 V	63 V	80 V	100 V	160 V	250 V
Up	11,5	18	29	46	72	92	115	184	288
Us								200	290

U <sub>R</sub>	350 V	360 V	385 V	400 V	450 V	480 V	500 V	550 V	630 V
Up	385	390	424	440	495	500	550	605	695
Us	405	405	430	450	500	540	600	650	700

## PERMISSIBLE REPETITIVE PEAK CURRENT I<sub>p</sub>:

If given corresponding max r.m.s. currents are not exceeded, peak current values are as follows:

DIMENSIONS in mm (inches)		I <sub>p</sub> (A)		I <sub>~max.</sub>		
Ø	H	40°C	85°C	(A)		
36	(1,417)	52	(2,047)	400	200	22
36	(1,417)	60	(2,362)	450	220	22
36	(1,417)	80	(3,150)	600	300	22
36	(1,417)	104	(4,094)	700	400	22
51	(2,008)	81	(3,189)	800	400	25
51	(2,008)	104	(4,094)	1100	500	25
66	(2,598)	104	(4,094)	1900	800	50
77	(3,031)	104	(4,094)	3100	1200	55
77	(3,031)	144	(5,669)	4200	1800	55
77	(3,031)	220	(8,661)	5700	2400	55
90	(3,543)	144	(5,669)	5700	2400	80
90	(3,543)	200	(7,874)	7700	3200	80

## EXPECTED LIFE WITH ID:

- 1 to 5 discharges per minute For I = I<sub>d</sub> 48 000 000 cycles  
In order to have the highest value of stored energy use preferably FELSIC 85 360 V.
- 10 discharges per minute For I = I<sub>d</sub> 36 000 000 cycles
- 15 discharges per minute For I = I<sub>d</sub> 18 000 000 cycles  
I = I<sub>d</sub>/2 > 1 x 10<sup>9</sup> cycles
- 15 to 60 discharges per minute  
To have the highest dissipated power, use preferably FELSIC 85 480 V, 500 V and 550 V and calculate r.m.s. current (general technical data § 6.4.2.).

## PERMISSIBLE RIPPLE CURRENT I (R.M.S. VALUE)

versus frequency f:

I<sub>~</sub>: permissible r.m.s. current at 100 Hz

f (Hz)	50	100	300	600	1 000	10 000	50 000
I	0,8 x I <sub>~</sub>	I <sub>~</sub>	1,2 x I <sub>~</sub>	1,3 x I <sub>~</sub>	1,35 x I <sub>~</sub>	1,5 x I <sub>~</sub>	1,6 x I <sub>~</sub>

## FAST DISCHARGES WORKING (I<sub>D</sub>)

Discharge current I<sub>d</sub> = peak current of 3 ms per cycle of 1 to 60 s, at 40°C.I<sub>d</sub> as a function of case

DIMENSIONS in mm (inches)		I <sub>d</sub>		
Ø	H	(A)		
36	(1,417)	52	(2,047)	230
36	(1,417)	60	(2,362)	300
36	(1,417)	80	(3,150)	440
36	(1,417)	104	(4,094)	580
51	(2,008)	81	(3,189)	740
51	(2,008)	104	(4,094)	990
66	(2,598)	104	(4,094)	1400
77	(3,031)	104	(4,094)	2000
77	(3,031)	144	(5,669)	2800
77	(3,031)	220	(8,661)	3700
90	(3,543)	144	(5,669)	3900
90	(3,543)	200	(7,874)	4800

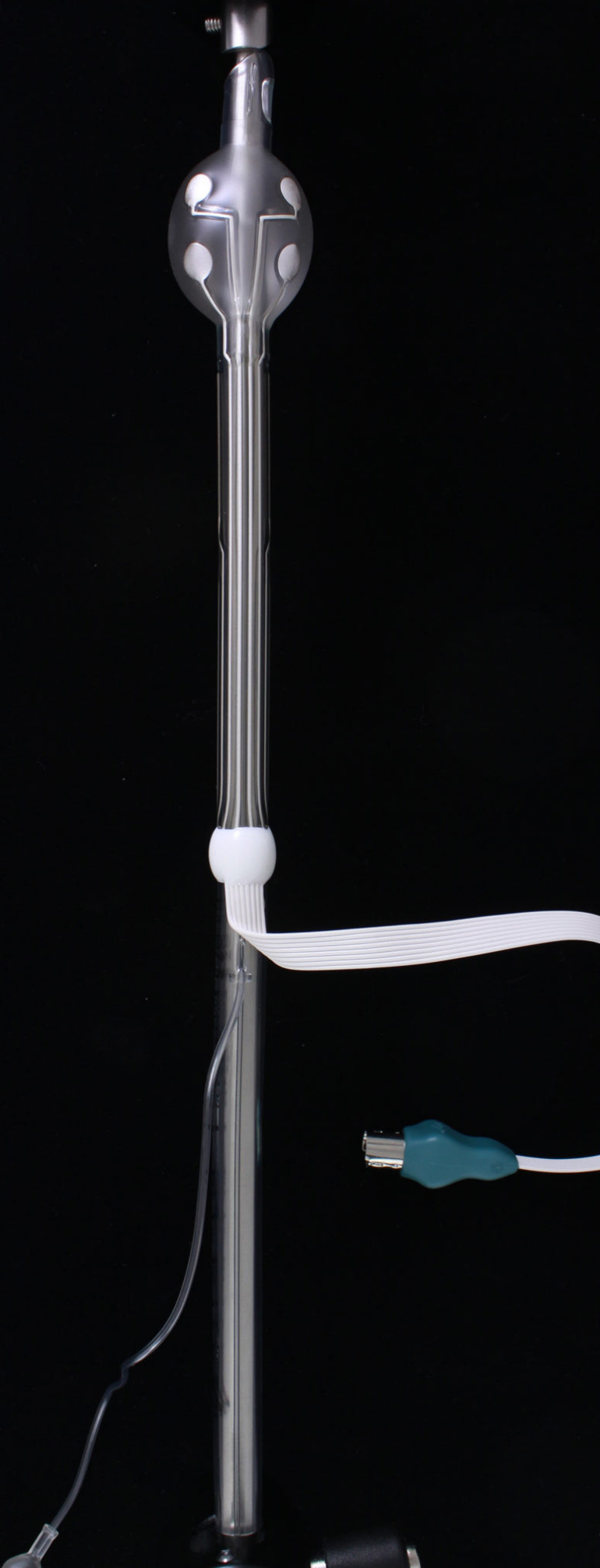

## Introduction.

Traditionally passive medical devices are becoming smarter. Examples include disposable ETT and catheters and temporary implantables that would reside in the body for less than 30 days, all the way to permanent implant devices like orthopedic hardware and bone repair kits. Today, they are providing surgeons with functionality and data that even a decade ago would have been regarded as science fiction. This trend, however, poses a particular challenge to device designers: To increase functionality while keeping the device small and safe for the patient. Of course, this is especially important for any device that is implantable.

Exxelia Micropen has been in on the development of many of these exciting devices. We are an organization with extensive expertise in developing, prototyping, and manufacturing medical tech. We have pioneering experience in direct write printed electronics technology, which we call Micropenning. Micropenning is an additive process (no wasted material) that writes fine-line conductive traces, sensors, and radiopaque markers directly onto a surface without the need for masks, appliques, or screens. What a decade ago might have been created with wires and attached sensors we can design today with printed electronics on the surface of the medical device substrate itself, thus adding desired functionality while saving valuable space and being safe for the patient. The printing can be done on just about any 3-dimensional shape and substrate with a variety of biocompatible inks to suit a particular requirement. The design can be configured to deliver heat, monitor vital signals, measure pressure, or other desirable properties.

# How to determine if you should explore Micropen Direct Write additive printing.

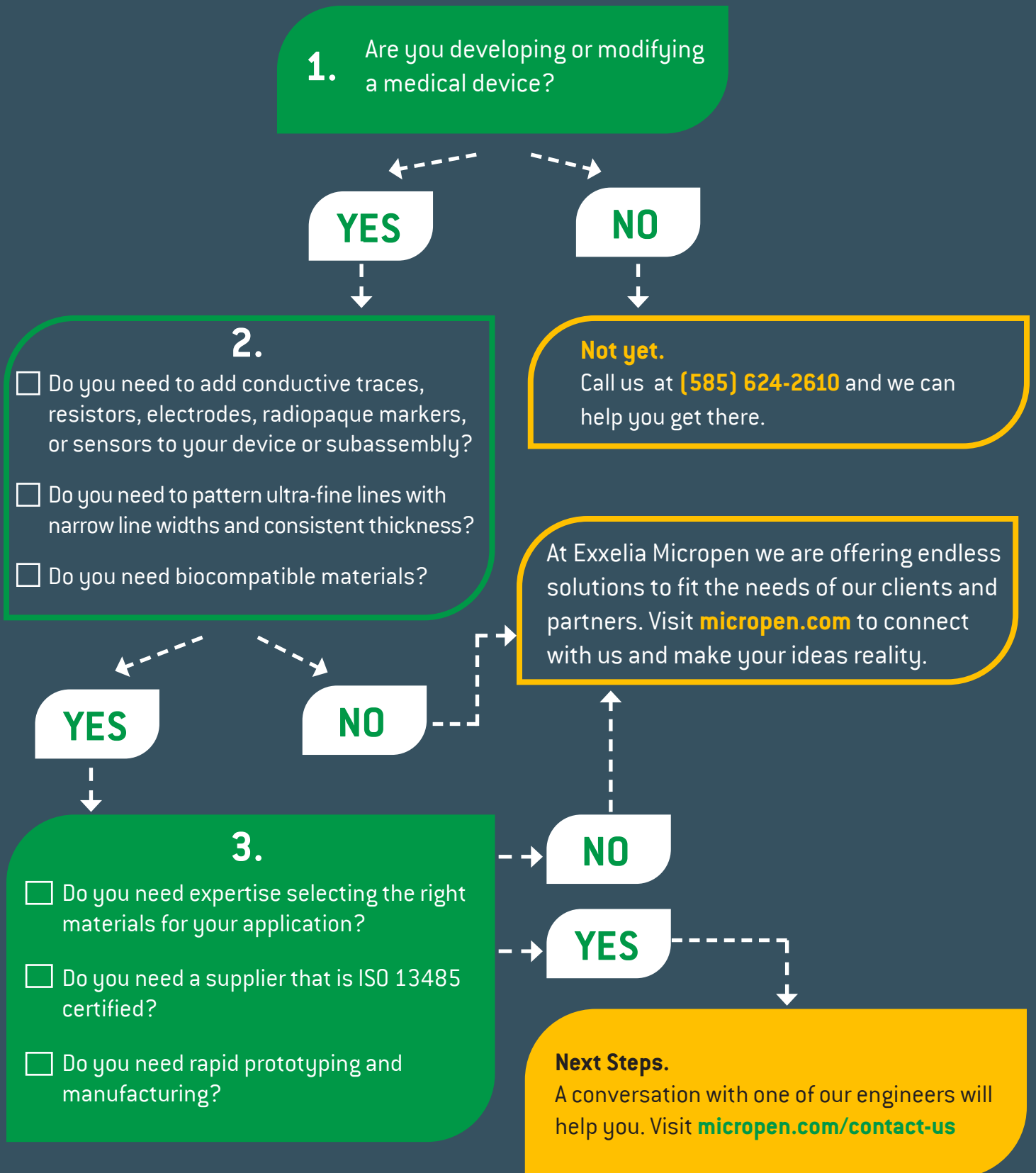

# Medical device design considerations: wear, duration, prototype cost, production quantity, unit cost (at scale) and medical device certification

As you proceed along your development journey, these design considerations/parameters are all important.

- Of course, wear goes hand-in-glove with duration of the device as a key property for the design. Exxelia Micropen has experience with devices on every side of this scale, from disposable one-use devices to permanent implants designed for longer-term use.
- Prototype/development cost and speed of prototyping are strong points for Exxelia Micropen as our technology lends itself to rapid prototyping. Micropenning requires no screens, masks or appliques, which can be costly and time consuming to setup. Since it is an additive process, there is no material wasted, so Micropenning can represent a substantial cost savings when expensive materials (like gold) are required.
- Talking to us early can help us design your prototype with scale in mind, so there is no need for a major redesign once the prototype is approved.
- Exxelia Micropen is ISO 13495 certified with years of medical device manufacturing experience, which means we have highly stringent quality systems in place and the expertise to ensure a successful project.

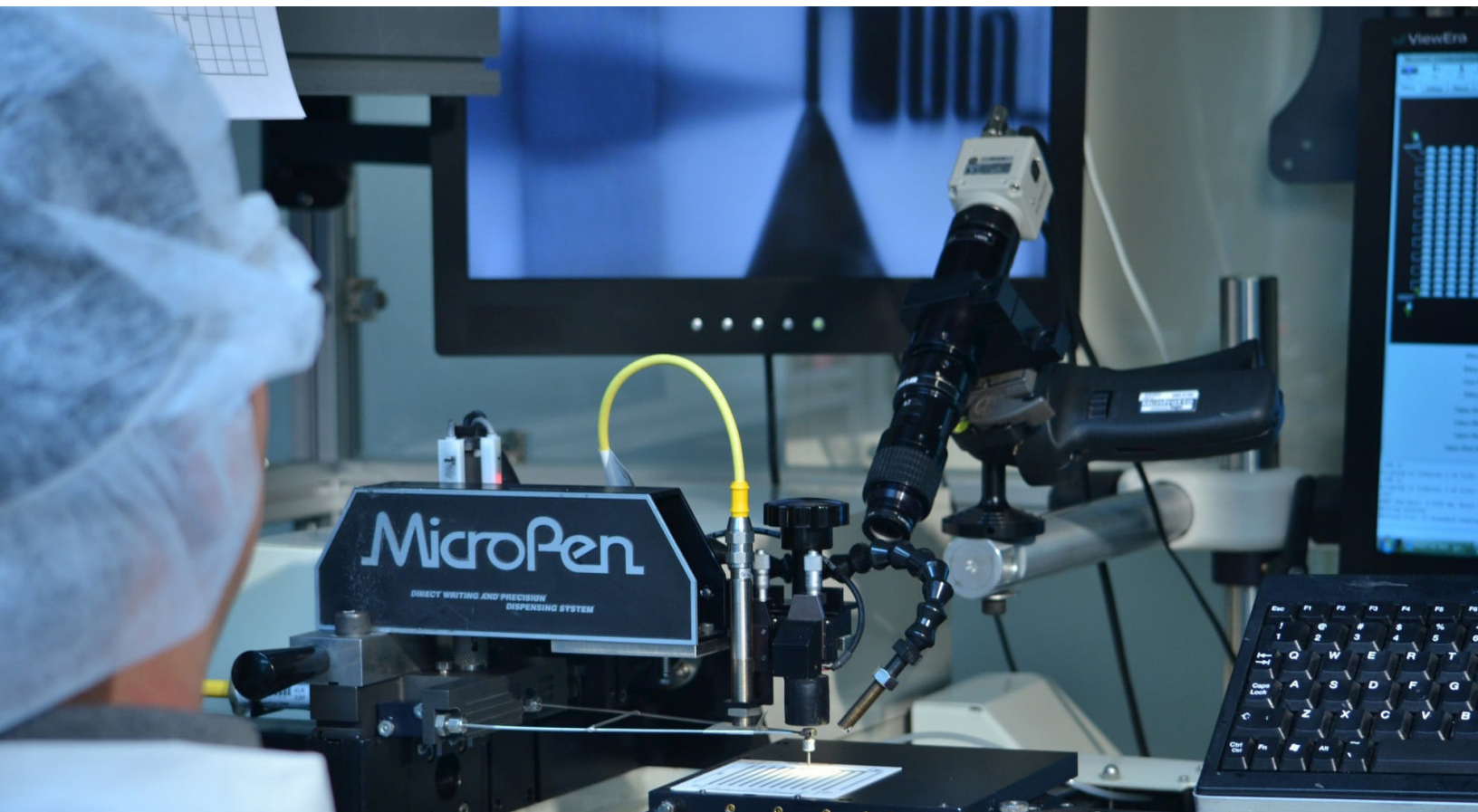

# 5 criteria for a successful path to printing electronics on a medical device.

1

## When considering a partner, do you sense their passion for quality?

Your design and manufacturing partner should have a culture throughout the entire organization of maintaining the highest level of quality. (It helps if they are certified ISO 13485, the medical device international standard for quality management.) This ensures that there are robust processes in place, from initial validation through qualification and production manufacturing. It also means that the organization can discover opportunities for improvement that can lead to greater efficiency and cost savings. Exxelia Micropen is certified as a contract manufacturer specializing in high-



precision electronic printing of critical functional materials of medical devices and components. The Micropen team is always looking for ways to improve on process and productivity.

2

## Do they have relevant experience in medical device design, prototyping, and production?

There are complex requirements in the healthcare industry, and a proven track record in the understanding of proper documentation, revision control, and maintenance of device history records and safety regulations will go a long way to ensure that your project is successful. An experienced partner can provide advice on design, suitable inks, techniques, and steps to optimize the process. This can lead to valuable time and cost savings over the course of the project. There is no substitute for experience in partnering on the design and manufacturing of printed electronics for the implantable medical device market. Exxelia Micropen has over 25 years of experience in working with top-tier medical device companies, printing electronics on endotracheal tubes, ablation devices, balloon catheters, etc. Our engineering and development teams have the necessary technical expertise, and our production, test, and quality teams understand what it takes to manufacture volume devices while maintaining competitive pricing. We understand that we are adding value to devices that will be used to save or enhance a patient's life.

### 3

## Could you envision them as a long-term partner and collaborator?

The most successful partnerships are long-term and collaborative. The resources on each team should have a shared understanding of the objectives and requirements, and the chosen supplier should be seen as an extension of your team. This allows challenges to be solved quickly and assures that the project will be completed on time and within budget. Regular meetings, passing files back and forth, and engaging experts in different functions of the organization are all elements of a partnership and lead to the success of the project. Your partner should be proactively communicating throughout the product lifecycle. Your partner may also consider investing in the partnership for the long-term. Over time, as you work together, you'll be able to apply learnings and efficiency to not only one product but a portfolio of products in a cost-effective and optimized way.

At Exxelia Micropen, we are committed to working collaboratively, starting early in the product design stage. We will share with you our accomplishments, manufacturing controls, and quality assurance process steps. We want you to get to know us, and the earlier we can engage with you as an integrated partner to your design team, the better. Most of our customers have been with us for years and we value a platform approach where we can apply our learnings to product extensions and next-generation designs.

### 4

## Can they scale and respond to demand changes?

It is important to choose a partner who can meet your production requirements now and into the future. The manufacturer should be agile and flexible in regard to your demand changes and able to meet your deliveries as agreed. This requires that they have a well-understood supply chain of raw materials and lead times. Make sure to ask about this when selecting a partner. At Exxelia Micropen we have the resources and experience to respond to growth and demand increases.

This is especially important in today's roller-coaster supply chain economy. We have excellent partnerships with suppliers of ink, substrates, and other raw materials and have a well-established process for supply chain management and production scheduling.

# 5

## Do they have an end-to-end process?

A full-service partner who can collaborate on product design, rapid prototyping, manufacturing, testing, and supply chain services is ideal. Consolidating all activities under one roof can reduce costs and time to market. It also allows for problems to be addressed quickly and eliminates the finger-pointing when multiple suppliers are involved. You should choose a partner who will complement your own team, adding value end-to-end.

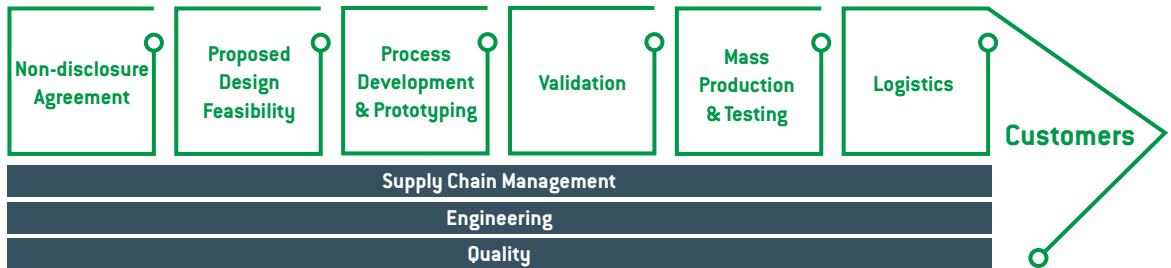

At Micropen we have expertise from design through manufacturing and responsive support throughout the product lifecycle. Our flexible printing manufacturing services can meet the needs of any company, from a start-up to a major OEM.

## Why Exxelia Micropen?

Exxelia Micropen has been a pioneer in medical device development with Micropen printed electronics technology for 25+ years. We are ISO 13485 certified, and we have the expertise to collaborate with you end-to-end from initial design concept through production.

### Links to Exxelia Micropen resources:

[Overview Video](#)

[Substrates & Inks](#)

[Medical Applications](#)

### Contact Us:

[micropen.com](http://micropen.com)

585-624-2610

[micropensales@exxelia.com](mailto:micropensales@exxelia.com)