

FP-60-700

Highlights

- Conduction cooled
- Polypropylene dielectric
- Self-healing
- Operating frequency up to 100 KHz
- Maximum operating core temperature 85°C
- Capacitance tolerance $\pm 10\%$
- Flame retardant UL94 - V0, ROHS compliant



Standard Capacitor Values

Rated Voltage Vrms	Nominal capacitance MFD at 1KHz	Max current Irms	Max power Kvars	Frequency KHz	ESR mΩ	Dimensions mm			Case Code	Terminal Style	Ordering Code
						B	H	L			
1000	5.0	800	700	22-29	0.7	72	130	130	0W8	5H	SP000051000W80W8005HK01
900	9.0	900	700	15.3-20	0.6	72	130	130	0W8	5H	SP000090900W80W8005HK01
850	12.0	1000	700	12.9-19	0.55	72	130	130	0W8	5H	SP000120850W80W8005HK01
	14.0	1000	700	11-16.2	0.5	72	130	130	0W8	5H	SP000140850W80W8005HK01
800	19.0	1000	700	9.2-12	0.4	72	130	130	0W8	5H	SP000190800W80W8005HK01
700	25.0	1050	700	9-10	0.35	72	130	130	0W8	5H	SP000250700W80W8005HK01
	27.0	1100	700	8.4-10.2	0.3	72	130	130	0W8	5H	SP000270700W80W8005HK01
600	33.0	1200	700	9.4-10	0.2	72	130	130	0W8	5H	SP000330600W80W8005HK01
	46.0	1200	700	6.7-7.1	0.15	72	130	130	0W8	5H	SP000460600W80W8005HK01
	63.0	1300	700	4.5-5.6	0.1	72	130	130	0W8	5H	SP000630600W80W8005HK01
500	80.0	1400	700	5.6-5.6	0.08	72	130	130	0W8	5H	SP000800500W80W8005HK01
	85.0	1400	700	5.2-5.2	0.07	72	130	130	0W8	5H	SP000850500W80W8005HK01

Capacitor Drawing and Terminal Style

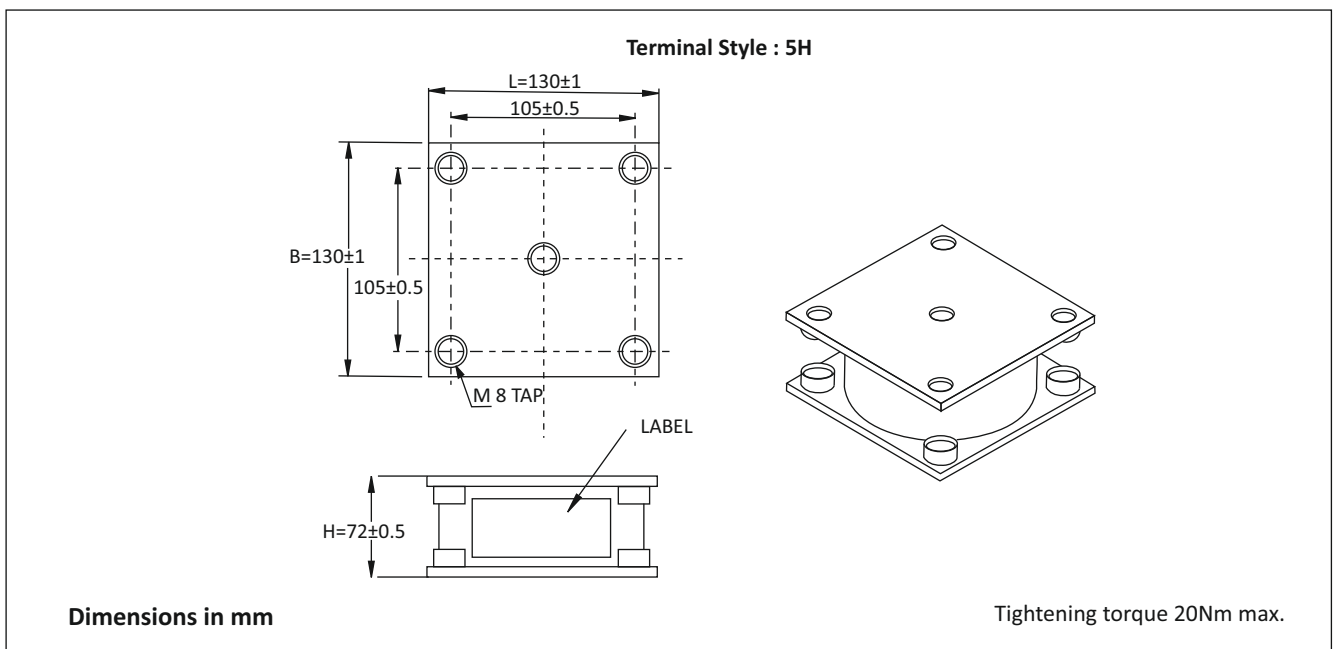

FP-60-700

Frequency Derating

—◆— Voltage —■— Current —▲— Power

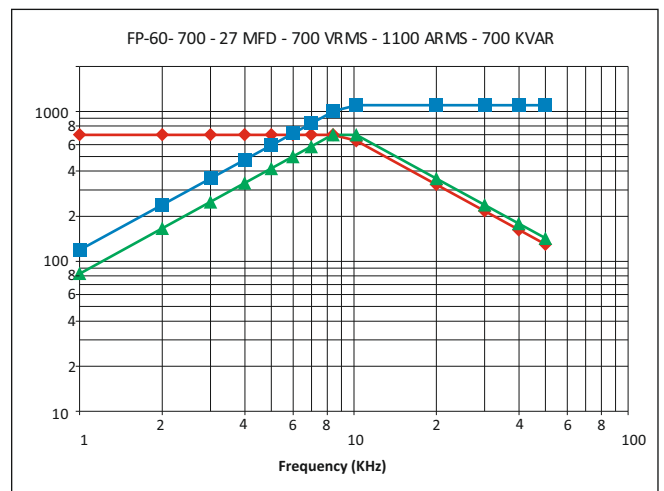
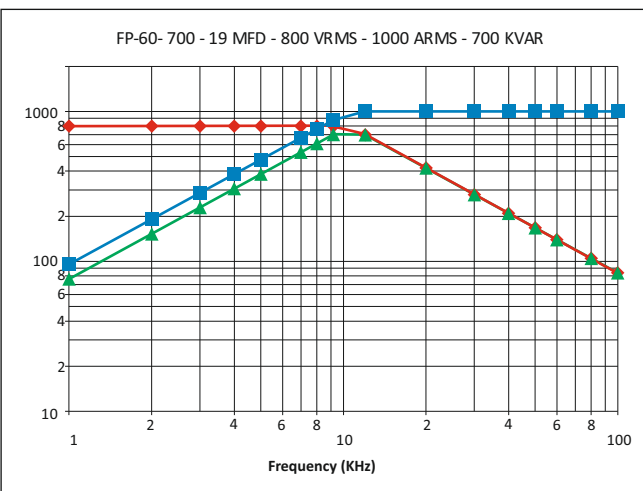
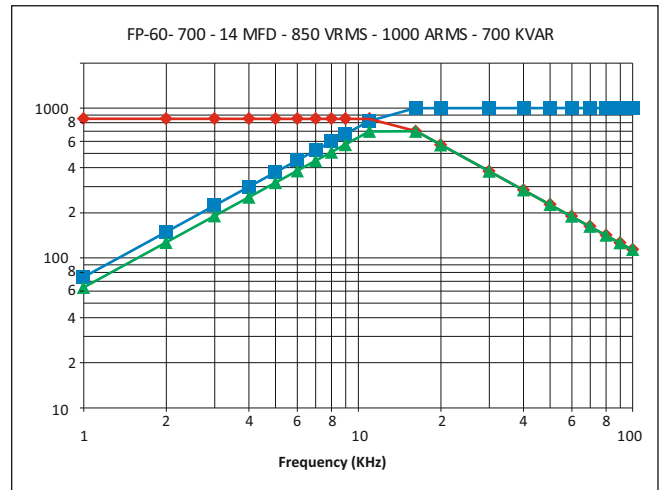
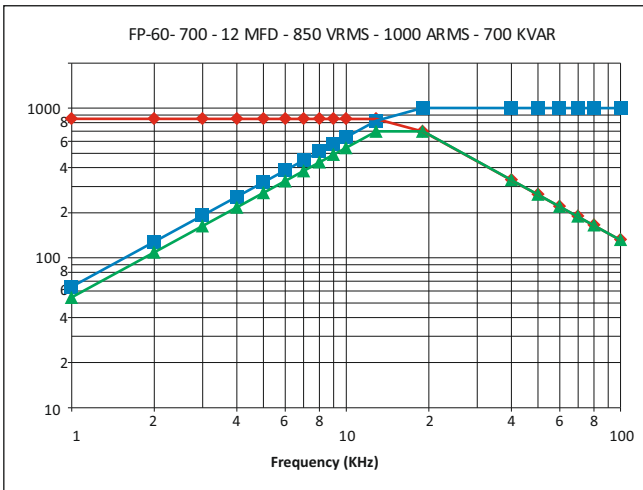
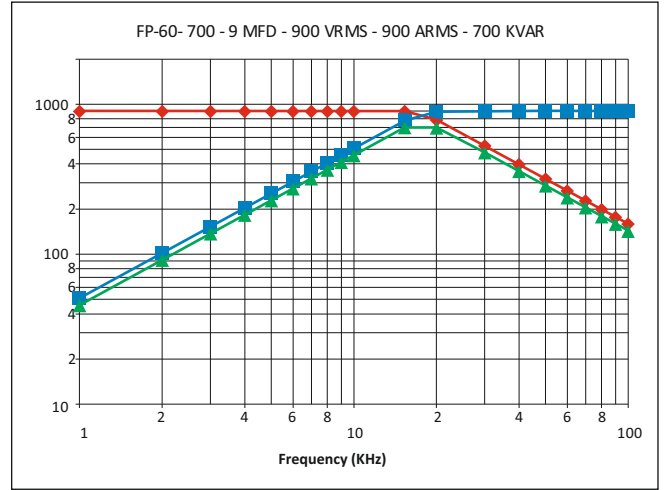
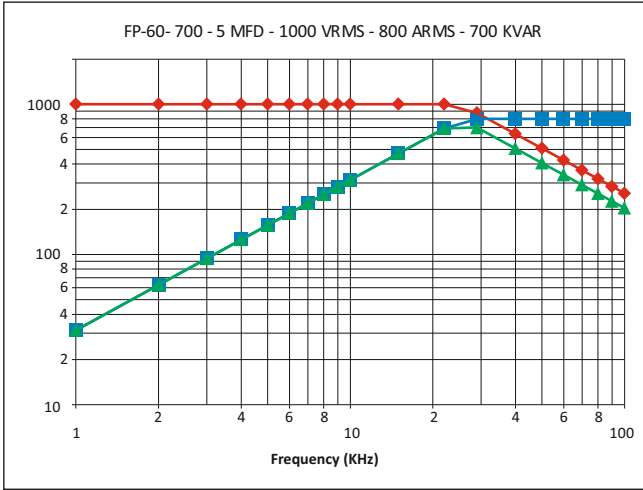

FP-60-700

Frequency Derating

—◆— Voltage —■— Current —▲— Power

