

FP-9-200

Frequency Derating

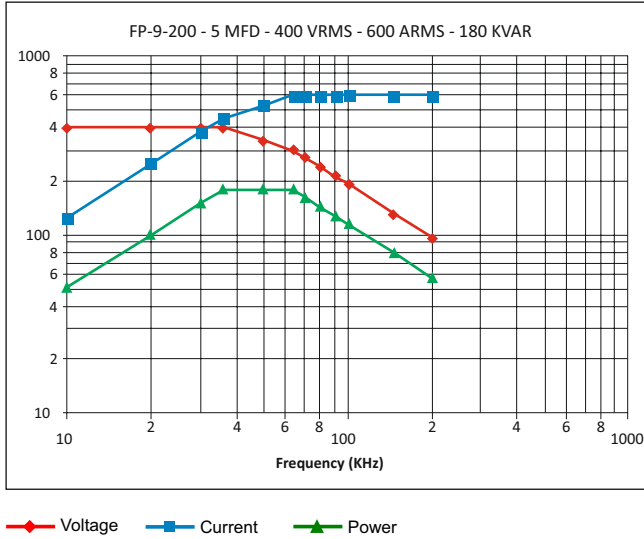

FP-5X-200-2C

Highlights

- Conduction cooled
- Polypropylene dielectric
- Self-healing
- Operating frequency up to 1400 KHz
- Maximum operating core temperature 85°C
- Capacitance tolerance $\pm 10\%$
- Flame retardant UL94 - V0, ROHS compliant



Standard Capacitor Values

Rated Voltage Vrms	Nominal Capacitance MFD at 1KHz	Max Current Irms	Max Power Kvar	Frequency KHz	ESR mΩ	Dimensions mm			Case Code	Terminal Style	Ordering Code
						B	H	L			
1100	0.025	200	180	948-1414	1.5	30.2	35	35	Z1	2C	SP0U0251100AU0Z1002CK01
1000	0.050	200	180	574-706	1.2	30.2	35	35	Z1	2C	SP0U0501000AU0Z1002CK01
	0.085	200	200	374	1.0	30.2	35	35	Z1	2C	SP0U0851000AU0Z1002CK01
900	0.100	250	200	394-501	0.9	30.2	35	35	Z1	2C	SP0U1000900AU0Z1002CK01
	0.170	250	200	232-294	0.8	30.2	35	35	Z1	2C	SP0U1700900AU0Z1002CK01
800	0.250	270	200	199-231	0.6	30.2	35	35	Z1	2C	SP0U2500800AU0Z1002CK01
700	0.330	300	200	197-217	0.4	30.2	35	35	Z1	2C	SP00U330700AU0Z1002CK01
600	0.660	350	200	134-148	0.4	30.2	35	35	Z1	2C	SP00U660600AU0Z1002CK01
500	1.200	400	200	106	0.4	30.2	35	35	Z1	2C	SP01U200500AU0Z1002CK01

Capacitor Drawing and Terminal Style

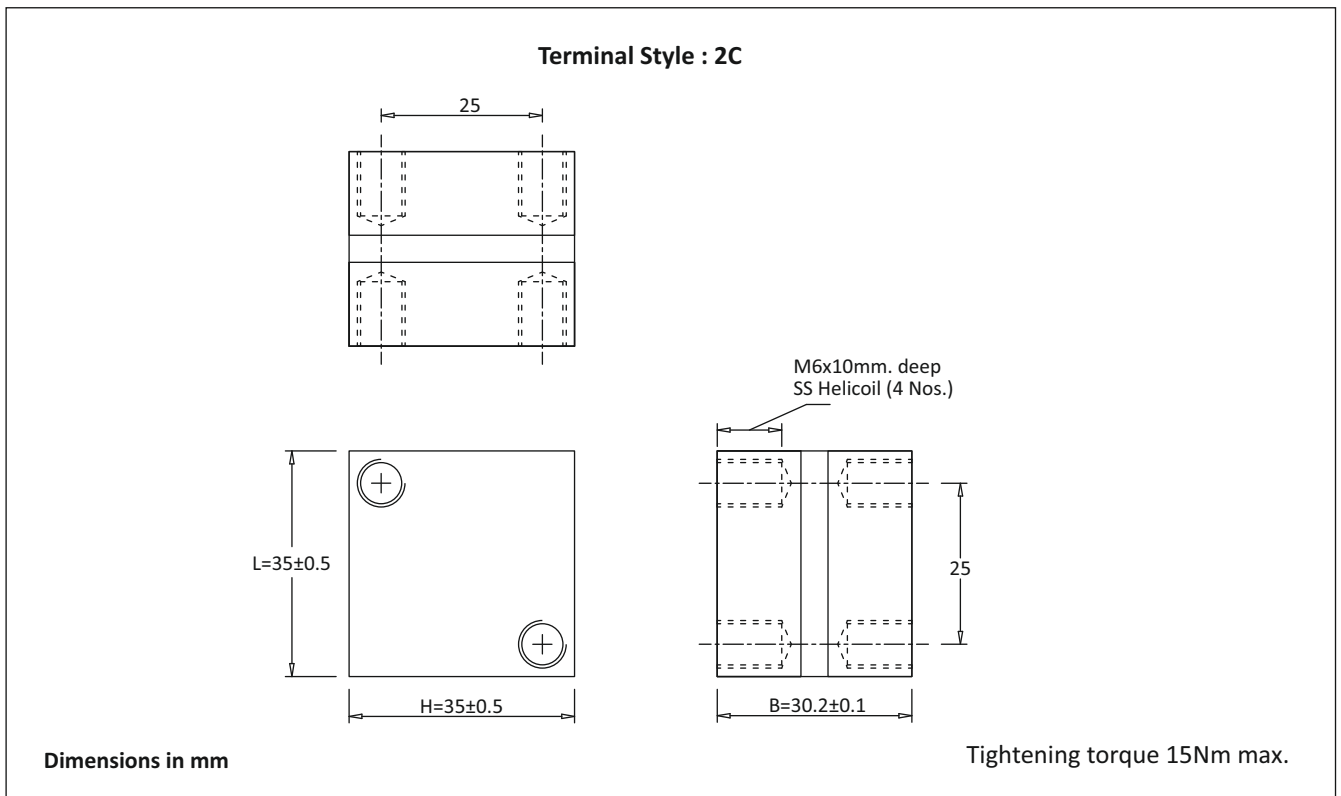

FP-5X-200-2C

Frequency Derating

—◆— Voltage —■— Current —▲— Power

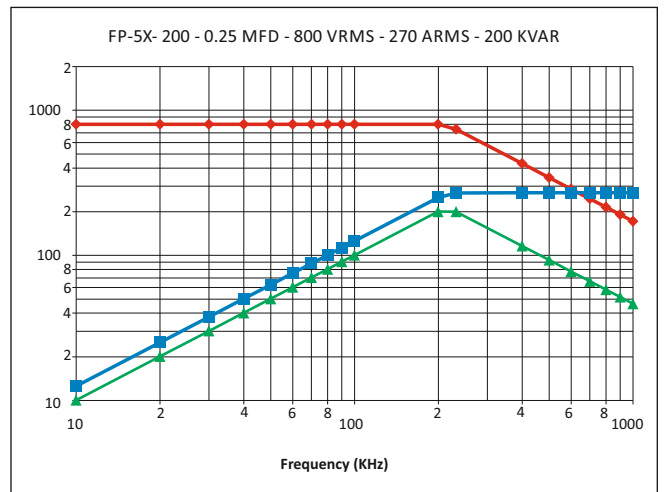
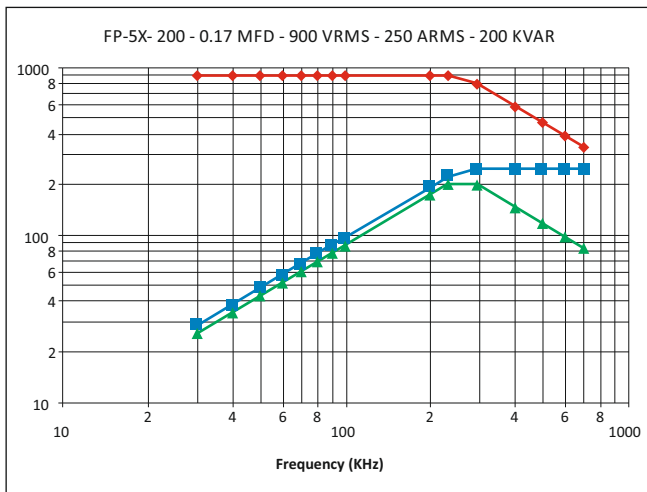
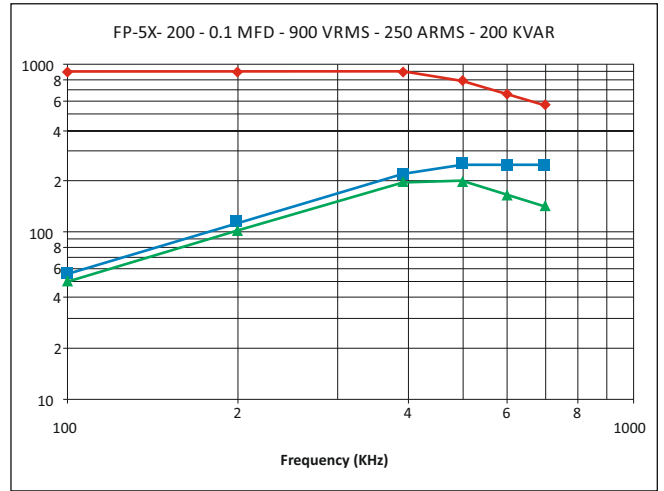
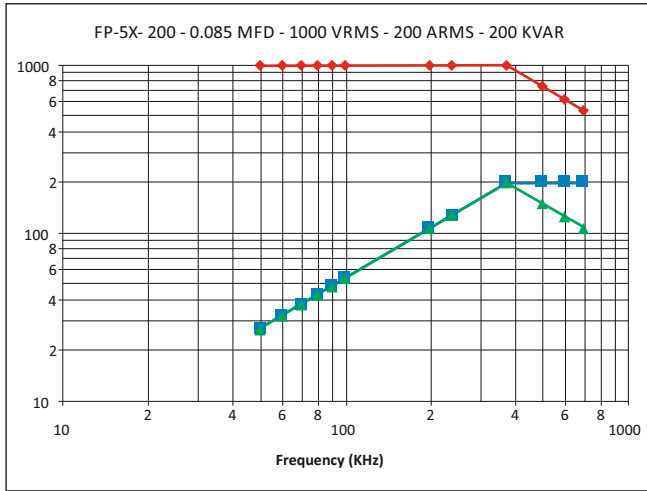
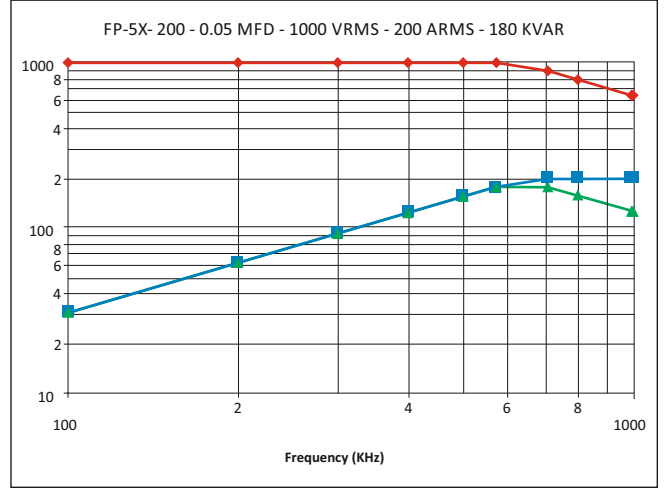
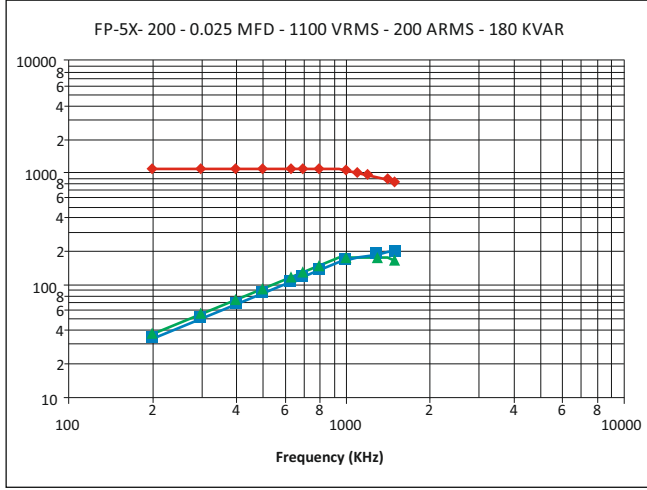

FP-5X-200-2C

Frequency Derating

—◆— Voltage —■— Current —▲— Power

