

FP-38-300-SM

Highlights

- Conduction cooled
- Polypropylene dielectric
- Self-healing
- Operating frequency up to 478 KHz
- Maximum operating core temperature 85°C
- Capacitance tolerance $\pm 10\%$
- Flame retardant UL94 - V0, ROHS compliant



Standard Capacitor Values

| Rated Voltage Vrms | Nominal Capacitance MFD at 1KHz | Max Current Irms | Max Power Kvar | Frequency KHz | ESR mΩ | Dimensions mm | | | Case Code | Terminal Style | Ordering Code |
|--------------------|---------------------------------|------------------|----------------|---------------|--------|---------------|----|----|-----------|----------------|-------------------------|
| | | | | | | B | H | L | | | |
| 1000 | 0.10 | 300 | 300 | 478 | 1.5 | 30.2 | 30 | 68 | D1 | SM | SP00U101000AX0D100SMK01 |
| | 0.17 | 300 | 300 | 281 | 1.4 | 30.2 | 30 | 68 | D1 | SM | SP00U171000AX0D100SMK01 |
| 800 | 0.33 | 400 | 300 | 225-256 | 1.2 | 30.2 | 30 | 68 | D1 | SM | SP00U330800AX0D100SMK01 |
| | 0.50 | 400 | 300 | 149-170 | 1.1 | 30.2 | 30 | 68 | D1 | SM | SP00U500800AX0D100SMK01 |
| 700 | 0.66 | 450 | 300 | 147-163 | 1.0 | 30.2 | 30 | 68 | D1 | SM | SP00U660700AX0D100SMK01 |
| 600 | 1.33 | 500 | 300 | 99 | 0.9 | 30.2 | 30 | 68 | D1 | SM | SP01U330600AX0D100SMK01 |
| 500 | 2.40 | 600 | 300 | 79 | 0.8 | 30.2 | 30 | 68 | D1 | SM | SP02U400500AX0D100SMK01 |

Capacitor Drawing and Terminal Style

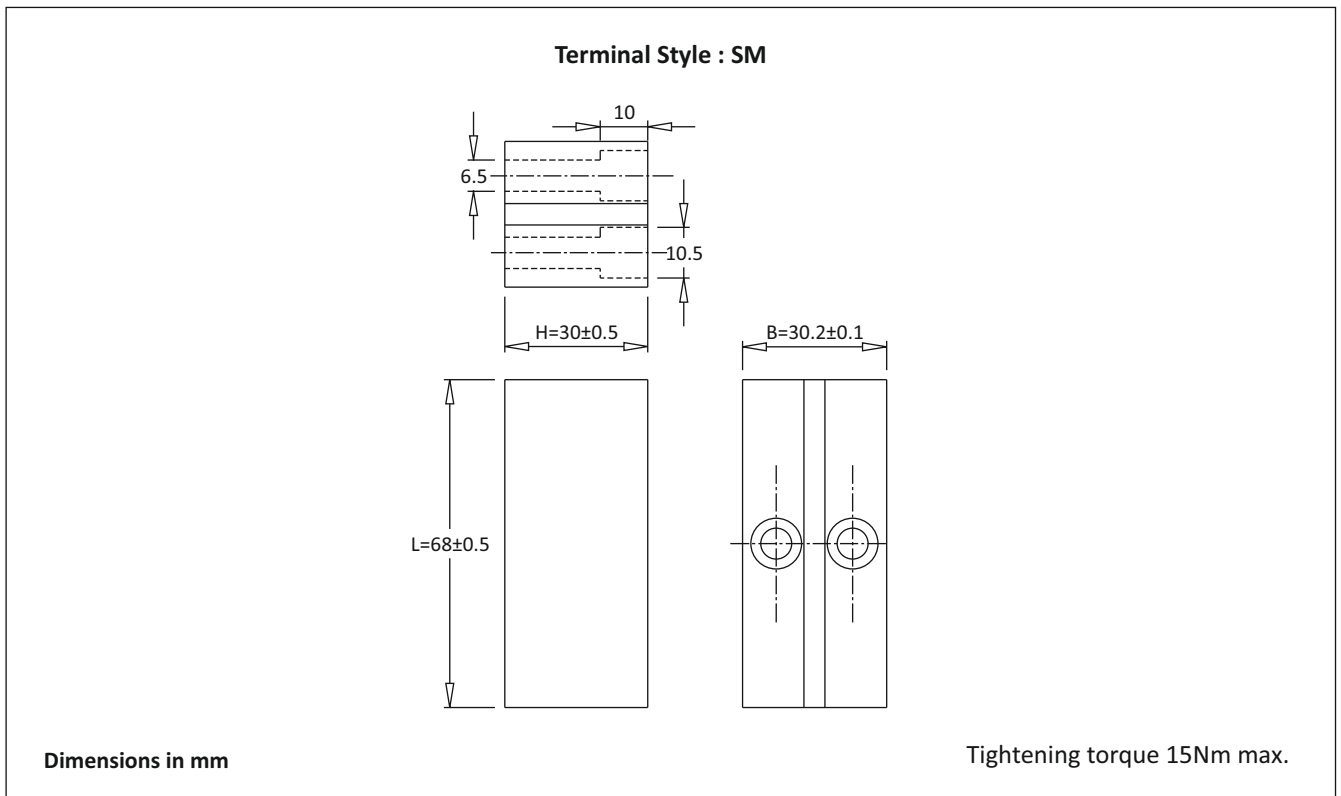

FP-38-300-SM

Frequency Derating

—◆— Voltage —■— Current —▲— Power

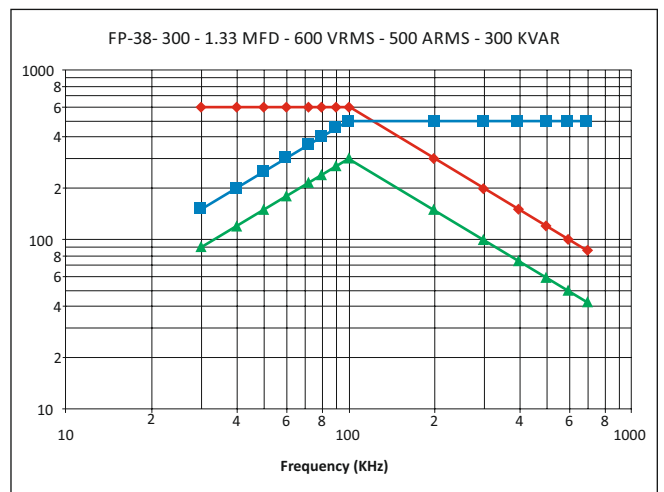
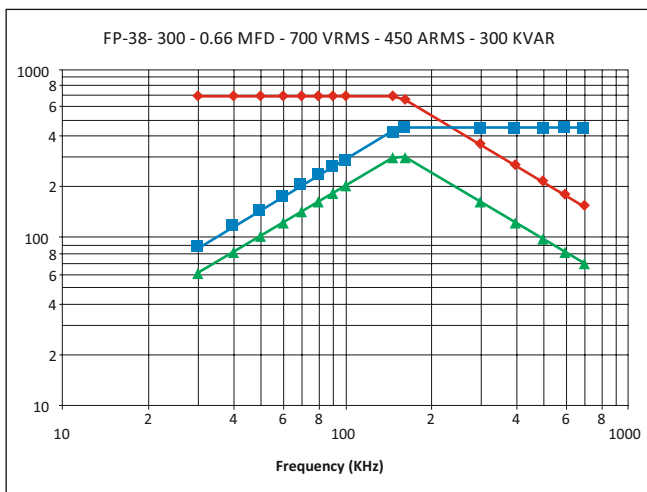
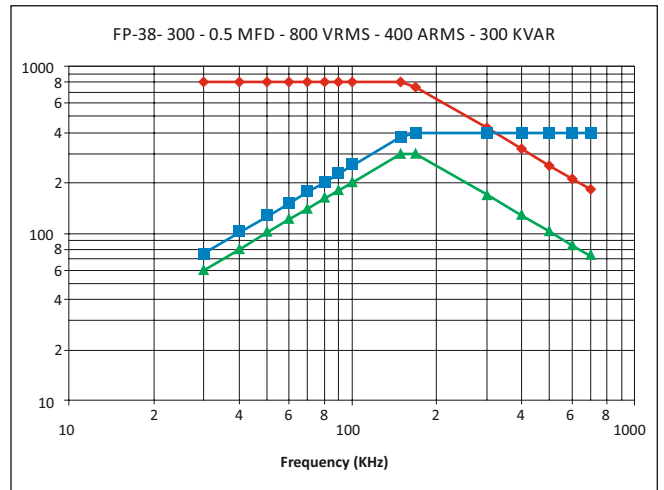
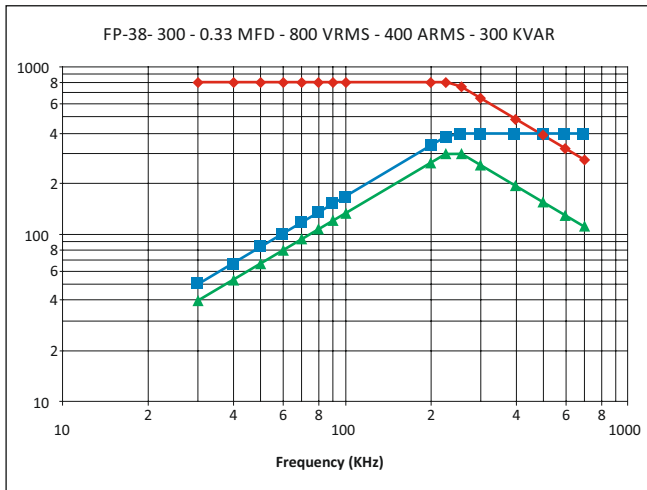
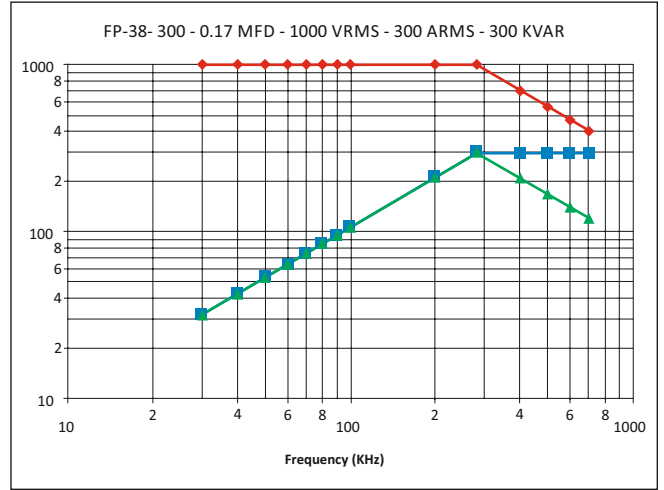
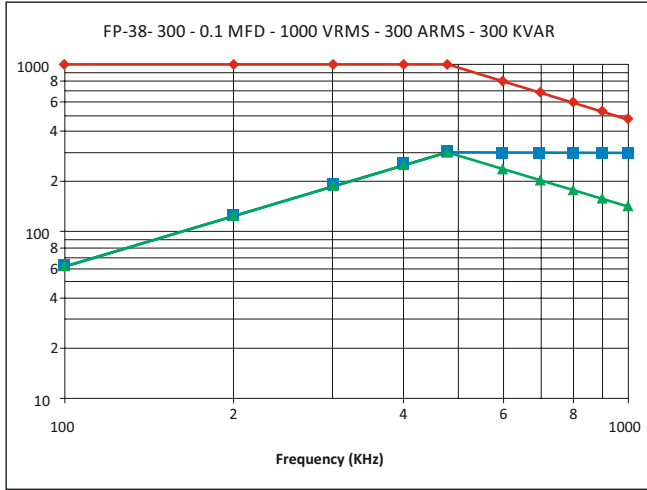

FP-38-300-SM

Frequency Derating

