

FP-36-500

Highlights

- Conduction cooled
- Polypropylene dielectric
- Self-healing
- Operating frequency up to 100 KHz
- Maximum operating core temperature 85°C
- Capacitance tolerance $\pm 10\%$
- Flame retardant UL94 - V0, ROHS compliant



Standard Capacitor Values

Rated Voltage Vrms	Nominal capacitance MFD at 1KHz	Max current Irms	Max power Kvars	Frequency KHz	ESR mΩ	Dimensions mm			Case Code	Terminal Style	Ordering Code
						B	H	L			
1100	1.2	600	500	55-96	1.5	100	54	100	G1	5H	SP01U2011000BAG1005HK01
	1.4	600	500	46-83	1.2	100	54	100	G1	5H	SP01U401100BAOG1005HK01
750	3.0	800	500	47-68	1.1	100	54	100	G1	5H	SP000030750BAOG1005HK01
	3.3	800	500	43-62	1.0	100	54	100	G1	5H	SP03U300750BAOG1005HK01
900	4.0	700	500	25-39	0.9	100	54	100	G1	5H	SP000040900BAOG1005HK01
700	5.6	1000	500	29-57	0.9	100	54	100	G1	5H	SP05U600700BAOG1005HK01
	6.3	1000	500	26-51	0.8	100	54	100	G1	5H	SP06U300700BAOG1005HK01
	8.5	1000	500	19-38	0.7	100	54	100	G1	5H	SP08U500700BAOG1005HK01
	10	1000	500	16-32	0.6	100	54	100	G1	5H	SP000100700BAOG1005HK01
500	21	1000	500	15	0.4	100	54	100	G1	5H	SP000210500BAOG1005HK01
550	27	1000	500	10-12	0.3	100	54	100	G1	5H	SP000270550BAOG1005HK01
500	33	1000	500	10	0.3	100	54	100	G1	5H	SP000330500BAOG1005HK01
	37	1000	500	9	0.2	100	54	100	G1	5H	SP000370500BAOG1005HK01

Capacitor Drawing and Terminal Style

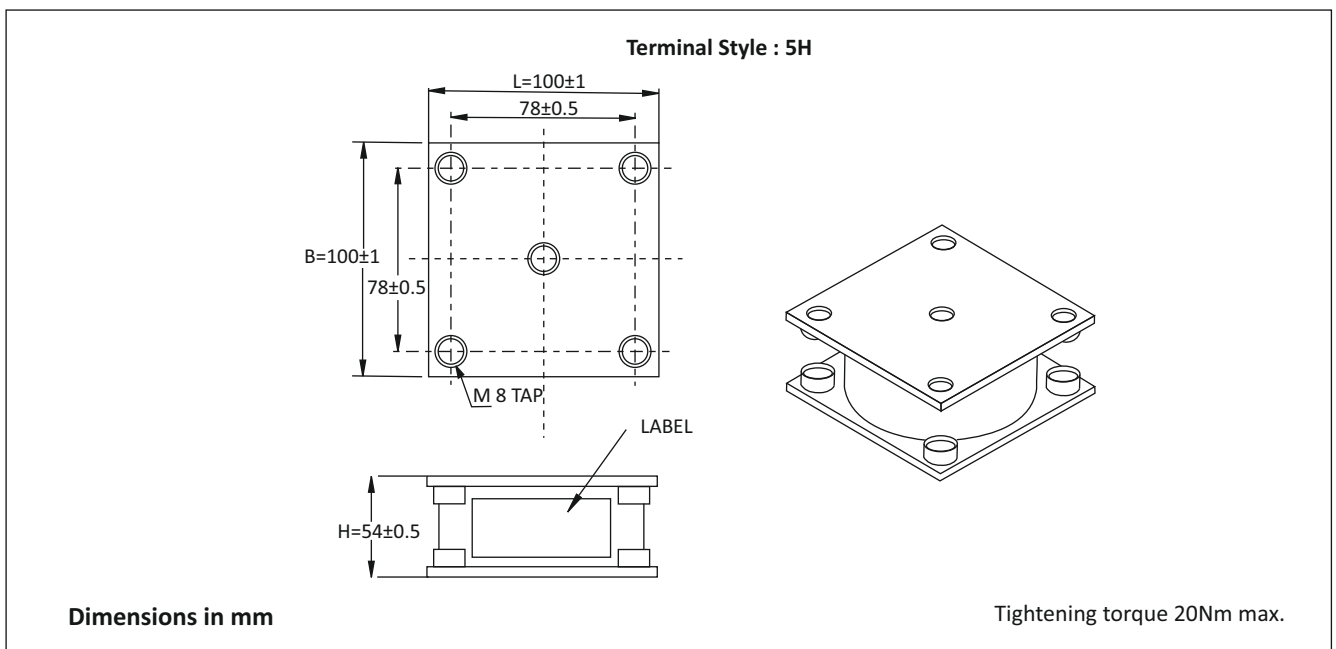

FP-36-500

Frequency Derating

—◆— Voltage —■— Current —▲— Power

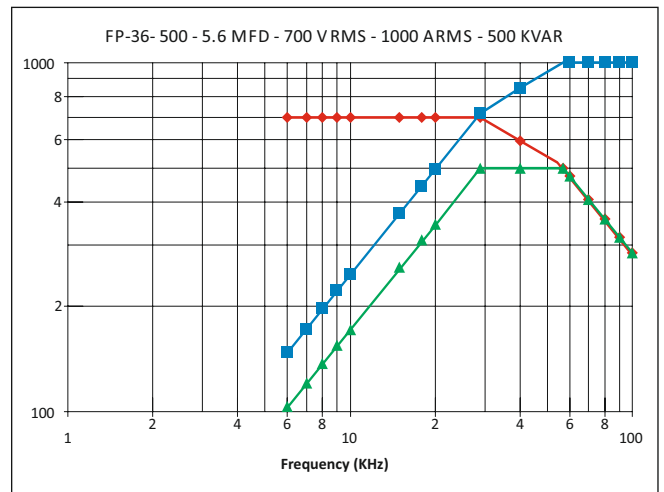
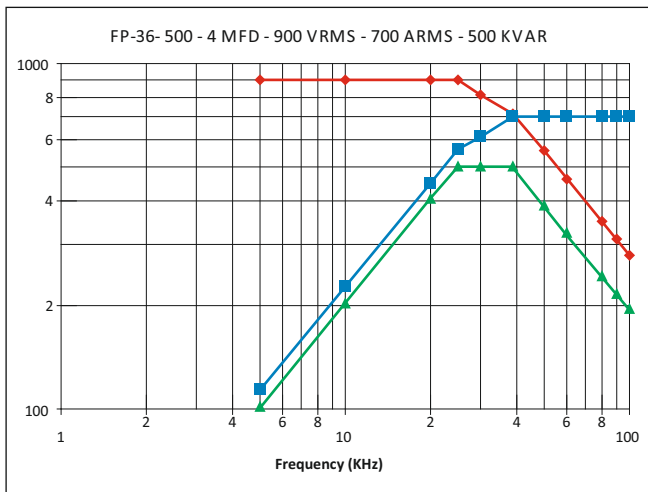
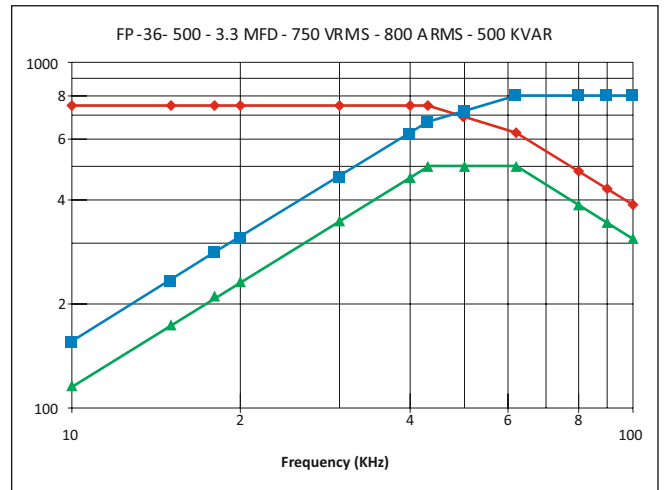
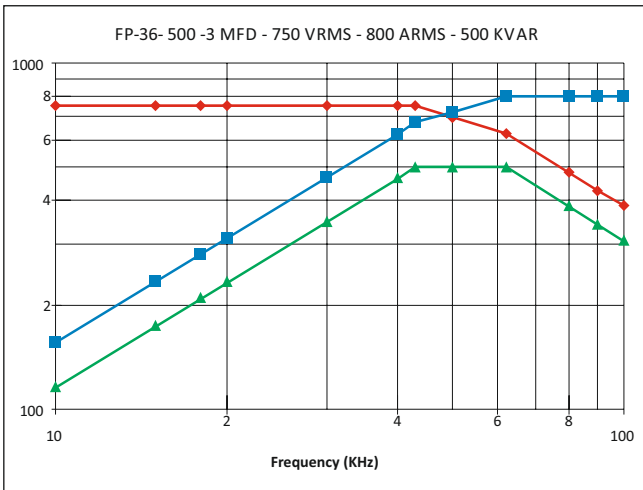
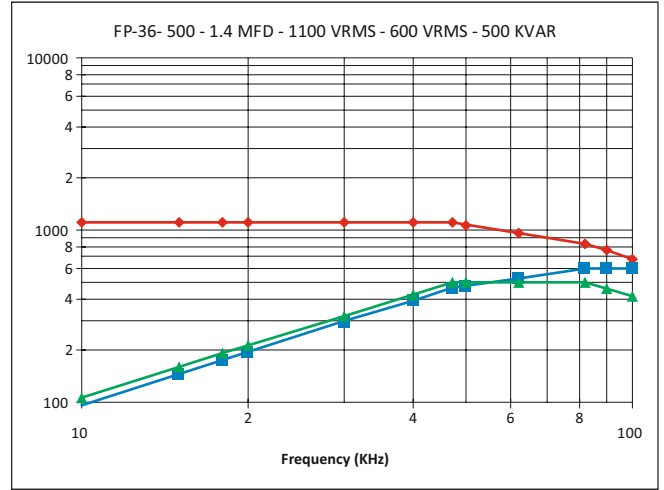
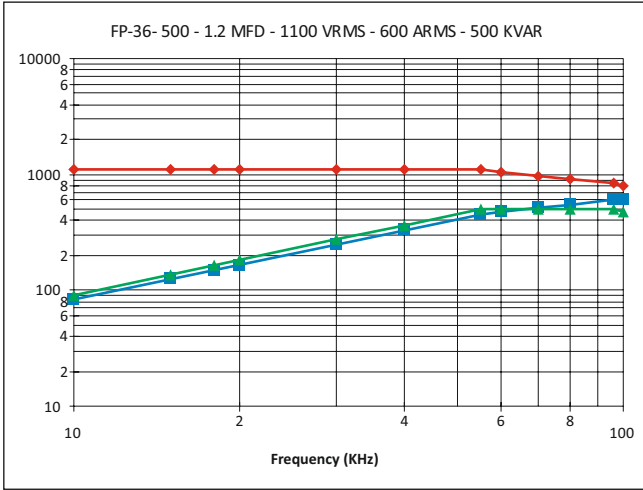

FP-36-500

Frequency Derating

—●— Voltage —■— Current —▲— Power

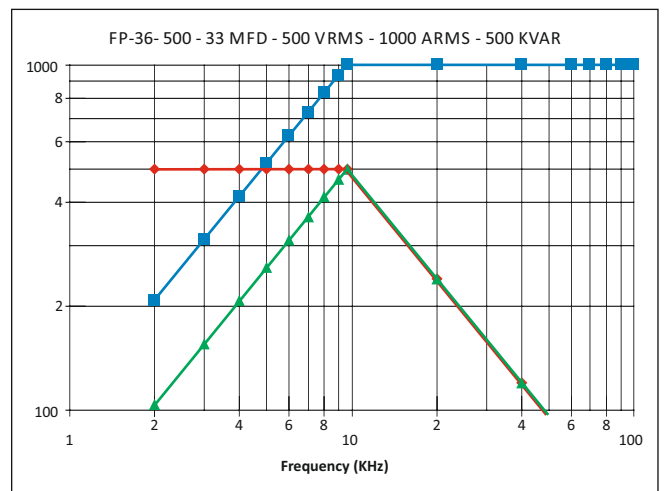
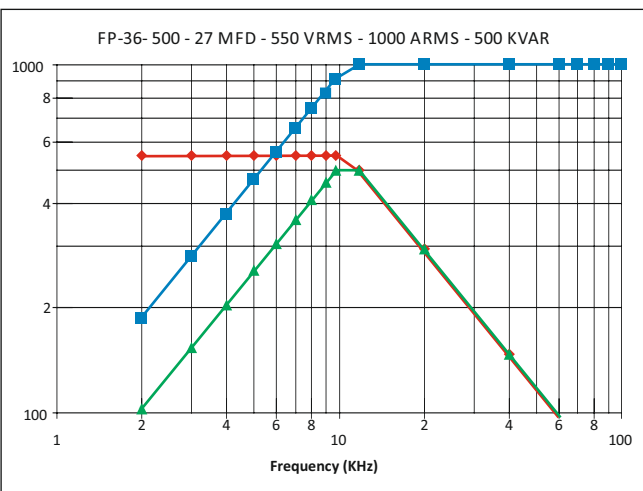
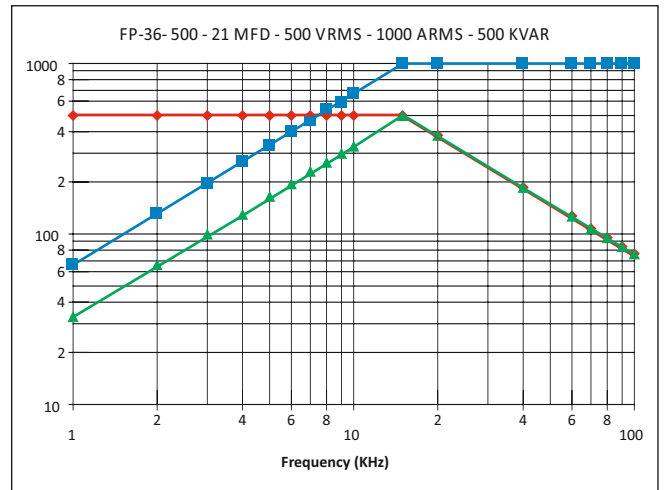
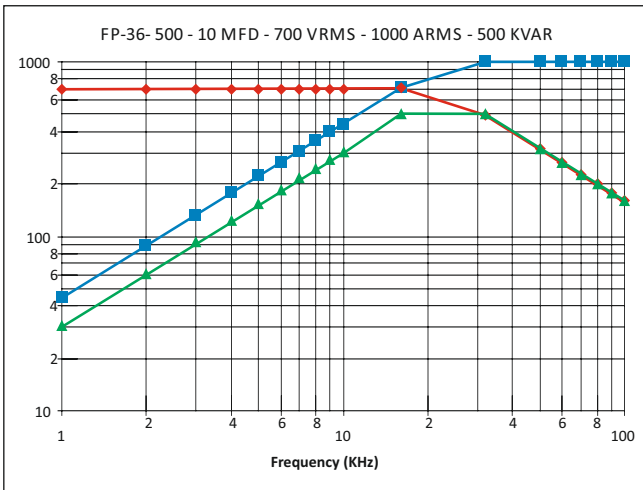
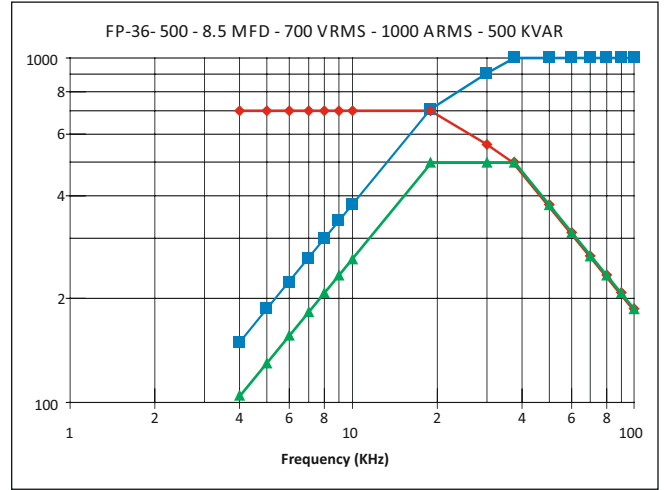
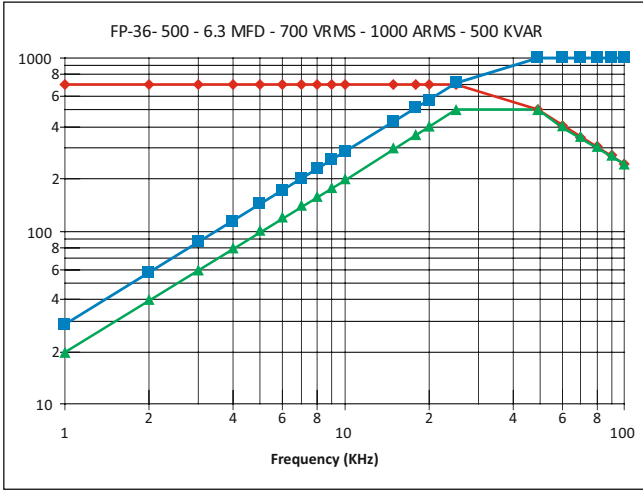

FP-36-500

Frequency Derating

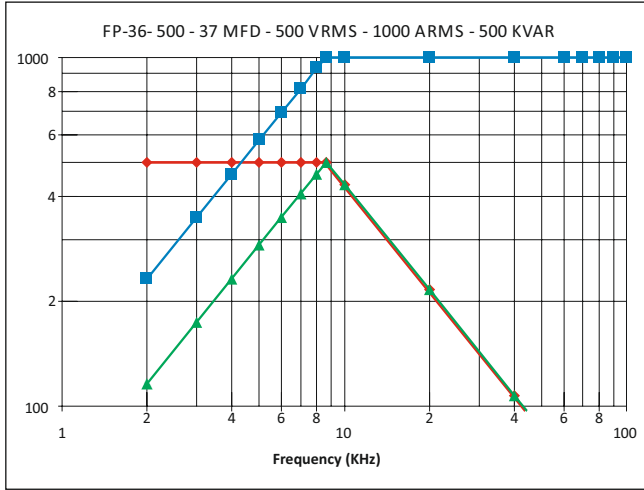

◆ Voltage
 ■ Current
 ▲ Power