

FP-20-400-SP

Highlights

- Conduction cooled
- Polypropylene dielectric
- Self-healing
- Operating frequency up to 700 KHz
- Maximum operating core temperature 85°C
- Capacitance tolerance $\pm 10\%$
- Flame retardant UL94 - V0, ROHS compliant



Standard Capacitor Values

Rated Voltage Vrms	Nominal Capacitance MFD at 1KHz	Max Current Irms	Max Power Kvar	Frequency KHz	ESR mΩ	Dimensions mm			Case Code	Terminal Style	Ordering Code
						B	H	L			
1000	0.10	400	400	637	1.5	30.2	30	68	D1	SP	SP00U101000A60D100SPK01
	0.17	400	400	375	1.4	30.2	30	68	D1	SP	SP00U171000A60D100SPK01
800	0.33	500	400	302	1.2	30.2	30	68	D1	SP	SP00U330800A60D100SPK01
700	0.50	650	400	260-336	1.1	30.2	30	68	D1	SP	SP00U500700A60D100SPK01
	0.66	650	400	197-255	1.0	30.2	30	68	D1	SP	SP00U660700A60D100SPK01
600	1.32	800	400	133-192	0.9	30.2	30	68	D1	SP	SP01U320600A60D100SPK01
500	2.40	800	400	106	0.8	30.2	30	68	D1	SP	SP02U400500A60D100SPK01

Capacitor Drawing and Terminal Style

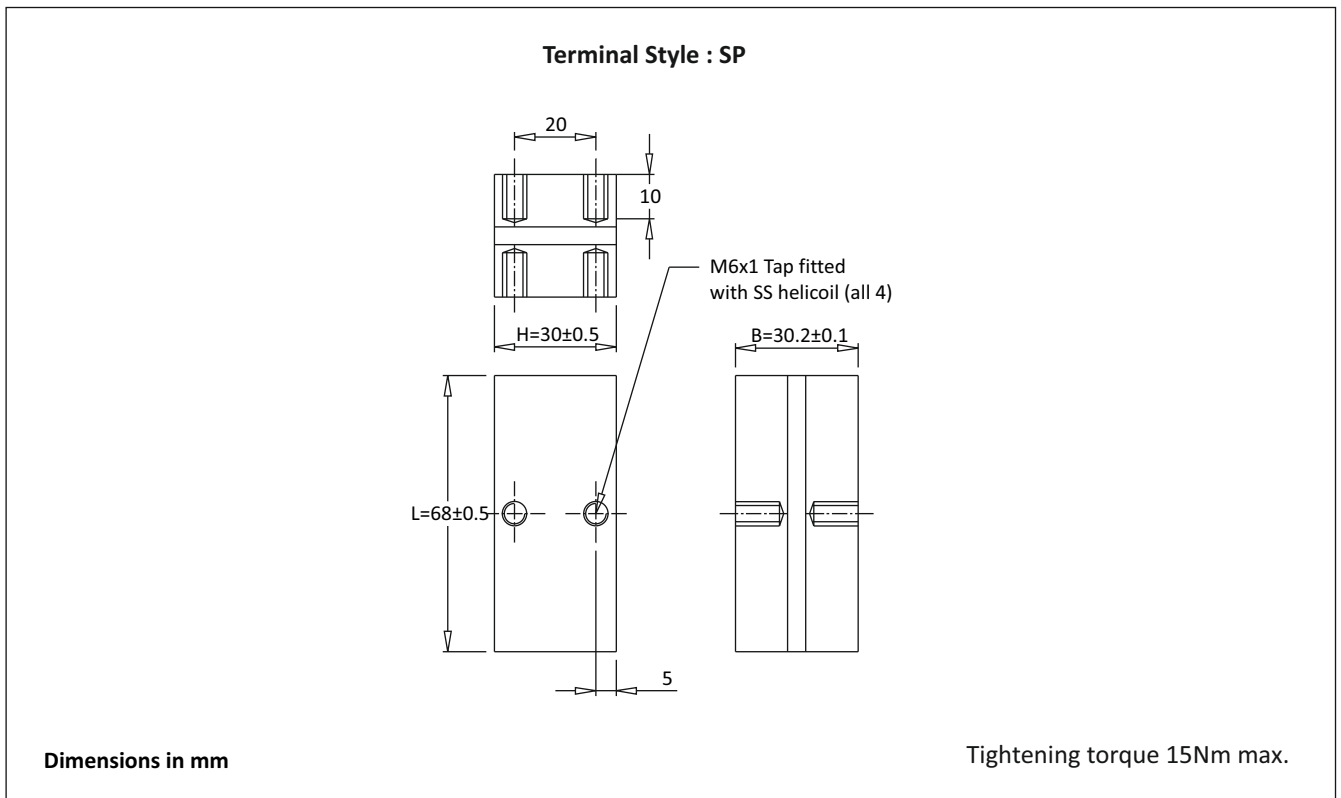

FP-20-400-SP

Frequency Derating

—●— Voltage —■— Current —▲— Power

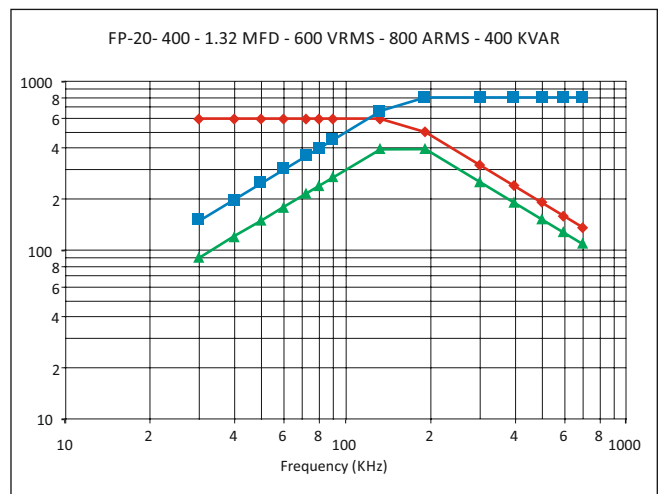
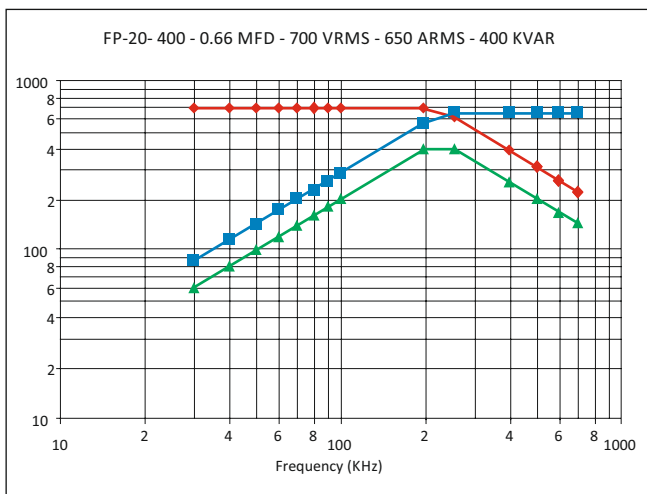
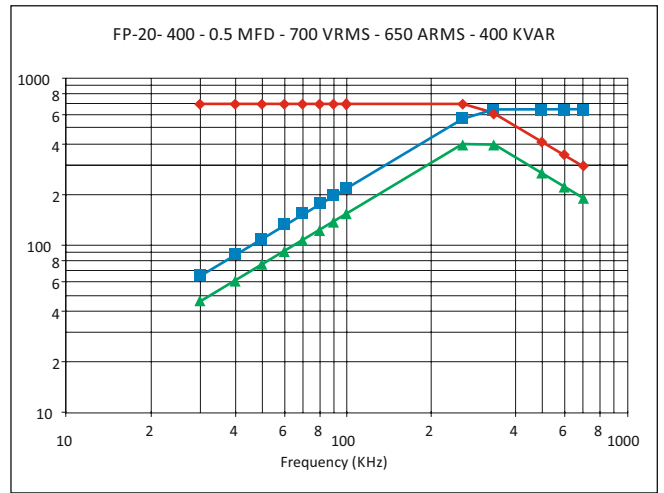
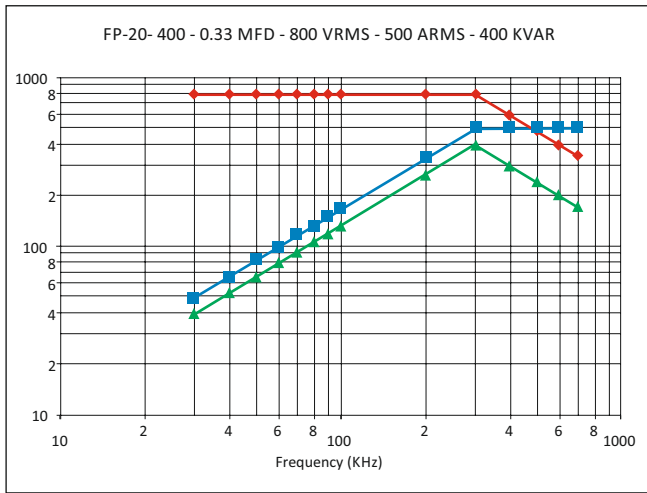
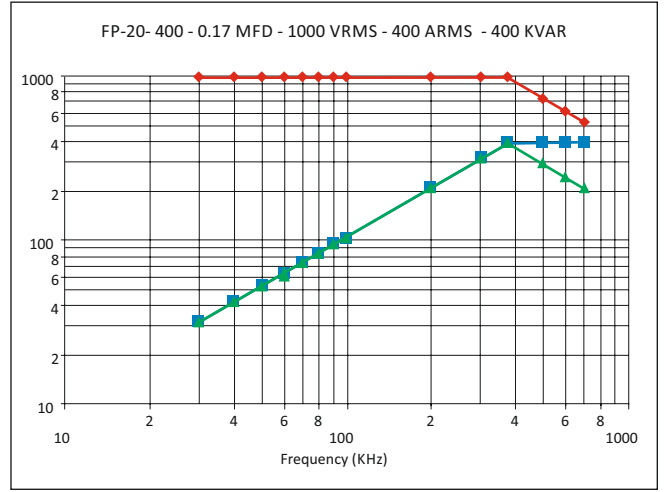
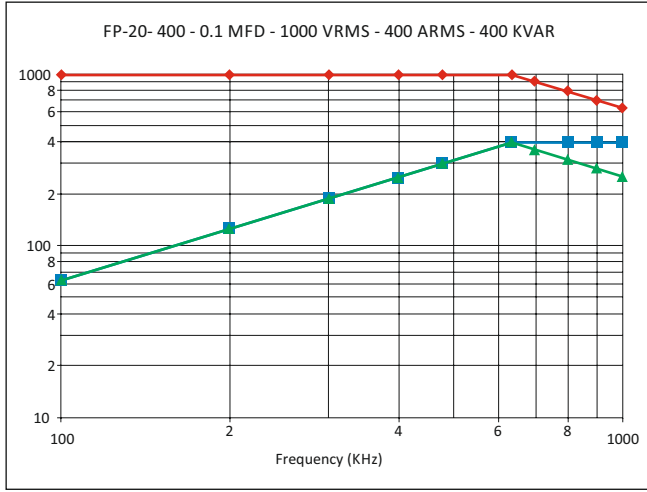

FP-20-400-SP

Frequency Derating

