

# FELSIC I-PLUS

BC - BD

10 000 h / 85°C

200 V ... 500 V	1 500 $\mu$ F ... 33 000 $\mu$ F	$\varnothing$ 51 mm ... $\varnothing$ 90 mm	- 55°C + 85°C	Long Life Time
-----------------	----------------------------------	---------------------------------------------	---------------	----------------



## APPLICATIONS WITH HIGH RIPPLE CURRENT I<sub>r</sub>

- Power electronics : converters, current inverters
- Switch mode power supplies
- Magnetization, welding machines, flash
- Circuit with high impulse current

Fixing : Clip or stud fixing

Screw terminals : M5 or M6

Tolerance on capacitance at 20°C :  $\pm 20\%$

Operating temperature : - 55°C + 85°C

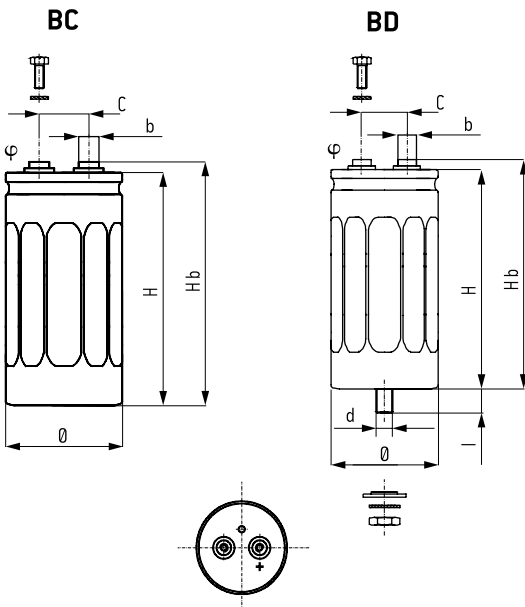

### DIMENSIONS (mm)

$\varnothing \pm 1$	H $\pm 2$	Hb $\pm 2$	C $\pm 0,5$	$\varnothing$	b
51	81	87	22,2	M5	13
51	104	110	22,2	M5	13
66	104	110	28,5	M5	13
77	104	111	31,7	M6	13
77	144	151	31,7	M6	13
90	144	151	31,7	M6	13
90	200	107	31,7	M6	13

d	l	Max. nut torque
M12	16 $\pm$ 1,5	10 Nm

### BC

Insulated aluminum case
Hexagonal screws
Spring washers
Fixing clip must be ordered separately

### BD

Aluminum case with sleeve
Hexagonal screws
Spring washers
Stud fixing delivered with capacitor [steel hex nut, spring washer]

### HEXAGONAL SCREWS

Screwing height between screws and terminals : 3,5 mm max

Max. screw torque : M5 : 3 Nm [x min 8 mm]  
M6 : 6 Nm [x min 10 mm]

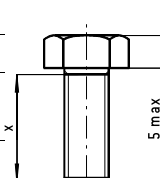

### RESISTANCE TO VIBRATIONS

$\varnothing$ (mm)	51 - 77	90
(Hz)	10 - 55 Hz	10 - 2000 Hz
Amplitude	0,75 mm	1,5 mm
Acceleration	10 g - 98 m/s <sup>2</sup>	20 g - 196 m/s <sup>2</sup>
t (h)	3 x 2 h	3 x 2 h

### SPECIFICATIONS

NFC 83 110

DIN 40 040 - Climatic category GPF

- 55°C + 105°C / 56 days

IEC 60 384.4 long life

Standard endurance test at U<sub>R</sub> : 5000 h / 85°C

### WITHSTAND STRENGTH OF INSULATING SLEEVE

Insulation resistance at 20°C between terminals and mounting hardware : 100 M $\Omega$

Test voltage at 50 Hz 1 min. between terminals and mounting hardware : 2000 V

Fire resistance : self extinguishing 15 s [IEC 60 695-2-2]

10 000 h / 85°C

Capacitance ( $\mu$ F)	Case		ESR		Z 10 kHz +20°C max. (m $\Omega$ )	II +20°C 5 min. max. (mA)	I~ +85°C		Code	
	Ø (mm)	H (mm)	Typic (m $\Omega$ )	100 Hz +20°C max. (m $\Omega$ )			100 Hz 10 000 h (A)	10 kHz 10 000 h (A)	BC	BD
<b>Rated voltage 200 V</b>										
3300	51	81	28	42	33	1,3	13	20	A 766204	A 767204
4700	51	104	20	30	27	1,9	17	26	A 766206	A 767206
6800	66	104	17	25	21	2,7	22	33	A 766208	A 767208
10000	77	104	13	20	15	4,0	27	41	A 766210	A 767210
15000	77	144	9	13	12	6,0	38	57	A 766212	A 767212
22000	90	144	5	8	7	8,8	55	80	A 766214	A 767214
33000	90	200	4	6	6	13,0	71	80	A 766216	A 767216
<b>Rated voltage 250 V</b>										
2200	51	81	40	70	45	1,1	11	17	A 766222	A 767222
3300	51	104	28	45	30	1,7	15	22	A 766224	A 767224
4700	66	104	20	30	22	2,4	20	30	A 766226	A 767226
6800	77	104	15	23	17	3,4	25	38	A 766228	A 767228
10000	77	144	12	18	13	5,0	33	49	A 766230	A 767230
15000	90	144	7	11	8	7,5	47	70	A 766232	A 767232
22000	90	144	5	8	7	11,0	55	80	A 766234	A 767234
<b>Rated voltage 350 V</b>										
2200	51	104	44	66	50	1,5	12	18	A 766262	A 767262
3300	66	104	30	45	35	2,3	16	25	A 766264	A 767264
4700	66	104	25	38	30	3,3	18	27	A 766266	A 767266
5600	66	104	23	35	28	3,9	19	28	A 766267	A 767267
6800	77	104	21	32	23	4,8	21	32	A 766268	A 767268
8200	77	144	13	20	15	5,7	31	47	A 766269	A 767269
10000	90	144	12	18	14	7,0	36	53	A 766270	A 767270
<b>Rated voltage 400 V</b>										
2200	66	104	42	63	45	1,8	14	21	A 766282	A 767282
3300	66	104	37	56	40	2,7	15	22	A 766284	A 767284
4700	77	104	25	38	30	3,8	20	29	A 766286	A 767286
5600	77	104	20	30	25	4,5	22	33	A 766287	A 767287
6800	77	144	14	21	17	5,5	30	45	A 766288	A 767288
10000	90	144	12	18	14	8,0	36	53	A 766290	A 767290
<b>Rated voltage 450 V</b>										
1500	51	104	75	120	85	4,0	9	13	A 766300	A 767300
2200	66	104	50	75	60	5,9	13	19	A 766302	A 767302
3300	77	104	35	52	42	8,9	17	25	A 766304	A 767304
4700	77	144	23	35	29	10,0	24	35	A 766306	A 767306
5600	77	144	21	32	25	11,0	25	37	A 766307	A 767307
6800	90	144	20	30	24	12,0	28	41	A 766308	A 767308
10000	90	144	13	20	16	13,0	34	51	A 766310	A 767310
<b>Rated voltage 500 V</b>										
1500	66	104	60	90	70	5,2	12	17	A 766320	A 767320
2200	66	104	50	75	60	6,2	13	19	A 766322	A 767322
2700	77	104	40	60	40	7,0	16	24	A 766323	A 767323
3300	77	144	30	45	36	7,7	21	31	A 766324	A 767324
4700	90	144	23	35	29	9,2	26	39	A 766326	A 767326
6800	90	144	21	32	27	11,0	27	40	A 766328	A 767328

# FELSIC I-PLUS

BC - BD

10 000 h / 85°C

## PERMISSIBLE REPETITIVE PEAK CURRENT $I_p$ :

If given corresponding max r.m.s. currents are not exceeded, peak current values are as follows

Dimensions (mm) :		$I_p$ (A)		$I_{\sim \text{max.}}$
$\emptyset$	H	40°C	85°C	(A)
51	81	800	400	25
51	104	1100	500	25
66	104	1900	800	50
77	104	3100	1200	60
77	144	4200	1800	60
90	144	5700	2400	80
90	200	7700	3200	80

## PERMISSIBLE RIPPLE CURRENT $I$ (R.M.S. VALUE)

versus frequency  $f$  :

$I_{\sim}$  : permissible r.m.s. current at 100 Hz

(Hz)	50	100	300	600	1 000	10 000	50 000
$I$	$0,8 \times I_{\sim}$	$I_{\sim}$	$1,2 \times I_{\sim}$	$1,3 \times I_{\sim}$	$1,35 \times I_{\sim}$	$1,5 \times I_{\sim}$	$1,6 \times I_{\sim}$

## CONNECTIONS IN SERIES :

Operating voltages exceeding 500 V up to 20000 V will be reached by connecting capacitors with rated voltages higher or equal to 350 V in series (see FELSIC in bank).

## EXPECTED LIFE

as a function of temperature :

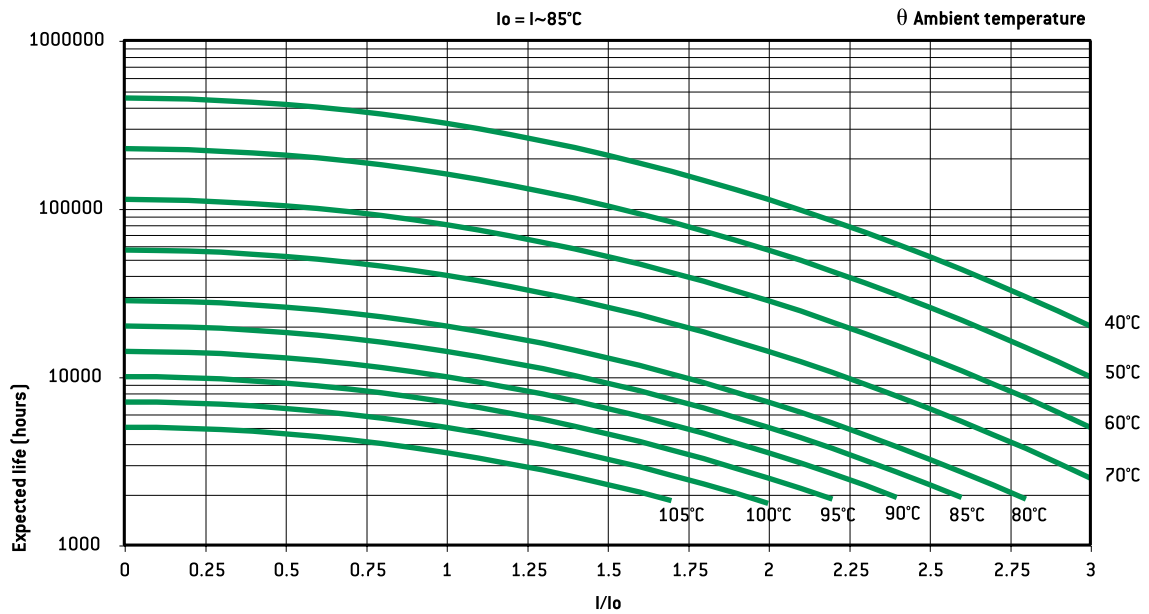

# General technical data

## 1. BASIC CONSTRUCTION

Structure of an electrolytic aluminum capacitor is shown hereunder :

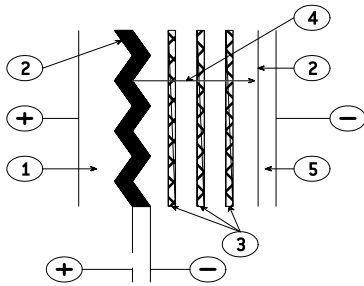

1. Anode : aluminum fo Il
2. Dielectric : aluminum oxide
3. Papers spacers impregnated with electrolyte
4. Ionic conduction assumed by electrolyte
5. Cathode : aluminum fo Il

The positive plate is an etched aluminum fo Il covered with alumina which is the dielectric of the capacitor.

The negative plate is constituted by a second aluminum fo Il which serves as a current supply, and by electrolyte-impregnated papers layers.

The metal used for anode is a  $\geq 99,98\%$  grade aluminum.

The dielectric has a thickness of  $13 \text{ \AA} / V$ .

The aluminum used for the cathode is a  $\geq 98\%$  grade aluminum covered with a dielectric layer with a thickness of about  $40 \text{ \AA}$ .

## 2. DIAGRAM OF THE EQUIVALENT CIRCUIT

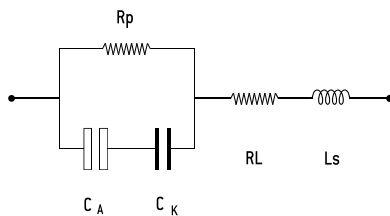

- $C_A$  = Capacitance of the anode  
 $C_K$  = Capacitance of the cathode  
 $R_p$  = Parallel resistance due to the aluminum oxide f Ilms.  
 $R_L$  = Series resistance of connections, plates and impregnated spacer.  
 $L_s$  = Inductance of winding and connections.

A standard simplified diagram is.

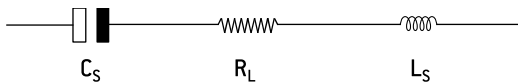

$C_s$  is the series capacitance of both anode and cathode capacitances.  
 Electrolytic aluminum capacitors are naturally polarized because of the insulating f Ilm on the anode. Given the very thin aluminum oxide layer, a reversed voltage should not exceed 1.5 V when there is energy supply.

Short duration reverse voltages can be absorbed by special construction, second anode replacing the former cathode.

## 3. CAPACITORS MARKING

### 3.1. ARTICLE CODE (ON EACH PACKAGING)

A followed by 6 figures number. First 3 positions are specific of the range.  
 (Ex. A 745xxx for a FELSIC 85 BD)

140	FELSIC en batterie / in bank
701	PRORELSIC 125
703	PRORELSIC 125
704	SNAPSIC
705	SNAPSIC 105
706	FELSIC HP BC – BD
708	PRORELSIC 145
710	CUBISIC
711	PROMISIC 031
712	CUBISIC LP
713	SNAPSIC 105 LP
714	SNAPSIC 4P
715	SNAPSIC 105 4P
716	SNAPSIC HV
717	SNAPSIC CAPAX
718	SNAPSIC 125
721	RELSIC 033
722	CI FRS
723	CI FRS
728	FELSIC 039 (ex 727) - FELSIC DI
730	ALSIC IR
732	ALSIC 105 FRS / ALSIC M 105 FRS
734	ALSIC HV $\emptyset \geq 22,5 \text{ mm}$
735	ALSIC HV $\emptyset < 22,5 \text{ mm}$
775	VACSIC
774	VACSIC 150
776	ALSIC 20G / ALSIC 145 20G

In FELSIC ranges, article code without first letter A, is printed on each capacitor.  
 a Figure 9 in fourth position shows a special product.

### 3.2. BATCH (ON EACH CAPACITOR).

3 figures or 6 figures

### 3.3. DATE (ON EACH CAPACITOR IF APPLICABLE)

4 figures (year-week)

## 4. ELECTRICAL CHARACTERISTICS

### 4.1. RATED CAPACITANCE $C_R$

The rated capacitance is defined at 100 Hz and at ambient temperature.

### 4.2. RATED VOLTAGE $U_R$

$U_R$  is the maximum DC voltage which may be applied in continuous operation.  
 When applying a superimposed alternating voltage, the peak value of the resulting waveform should not exceed the rated voltage.

### 4.3. PEAK VOLTAGE $U_p$

$U_p$  is the maximum repetitive voltage which can be applied within short periods.  
 Defined in CECC 30 300 and IEC 60 384-4 :

1000 cycles of 30 s charge followed by a no load period of 5 min. 30 s with upper category temperature.

$$U_p \geq 1,15 U_R \quad (U_R \leq 315 \text{ V})$$

$$U_p \geq 1,10 U_R \quad (U_R > 315 \text{ V})$$

# General technical data

## 4.4. DISSIPATION FACTOR TANδ

The dissipation or loss factor is defined by its tangent  $\text{Tan}\delta$

$$\text{Tg}\delta = R_s C_s \omega$$

$$(\omega = 2\pi F)$$

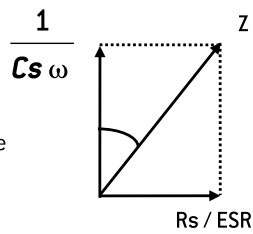

**ESR** Capacitor Equivalent Series Resistance

**Cs** Capacitor capacitance

**F** Frequency [100 Hz]

**Z** Capacitor impedance

## 4.5. EQUIVALENT SERIES RESISTANCE ESR

The relation between ESR and dissipation factor  $\text{Tan}\delta$  is given in § 4.4.

## 4.6. IMPEDANCE Z - INDUCTANCE L

The impedance is given by :

$$Z = \sqrt{R^2 + \left(L\omega - \frac{1}{C\omega}\right)^2}$$

L inductance. Generally L = 5 to 20 nH

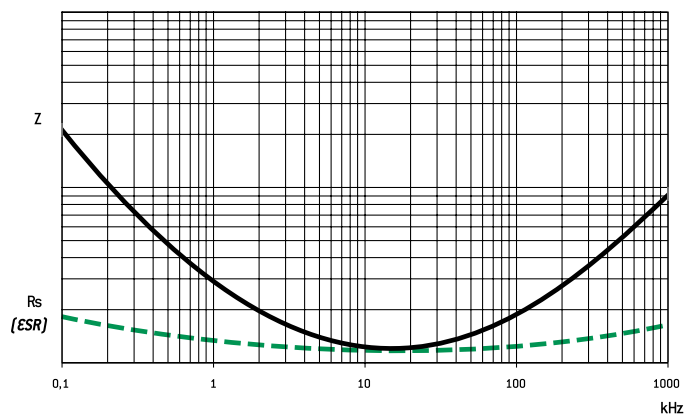

Z and ESR as function of frequency typically follows the chart :

## 4.7. PERMISSIBLE RIPPLE CURRENT (I r.m.s.) I~

The current is defined at the maximum climatic category and at 100 Hz. It is the root mean square value r.m.s. The value  $I_0$  is the rated value for calculations of expected life up to 3  $I_0$ .

## 4.8. LEAKAGE CURRENT II

It is measured at 20°C after a 5 min. polarization under rated voltage.

For  $C_R$  in  $\mu\text{F}$  and  $U_R$  in V :

$$I \leq 0,01 C_R U_R \text{ or } 1 \mu\text{A}^*$$

when  $C_R U_R \leq 1000 \mu\text{C}$

$$I \leq 0,006 C_R U_R + 4 \mu\text{A}$$

when  $C_R U_R > 1000 \mu\text{C}$

For  $U_R > 350 \text{ V}_{\text{DC}}$  it can be specified :

with  $K = 4, 6 \text{ or } 8$

or

$$I \leq 0,3 (C_R U_R)^{0,7} + 4 \mu\text{A} \text{ (CECC 30 300)}$$

\* Whichever is the greater

## 4.9. CHARACTERISTICS

Versus temperature (typical values).

### 4.9.1. Capacitance drift

Versus temperature

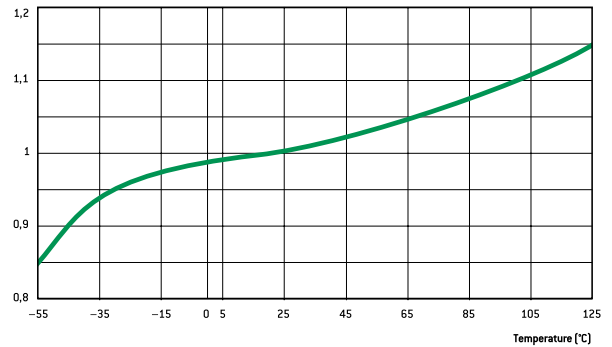

### 4.9.2. ESR and Z drifts at 100 Hz

Versus temperature

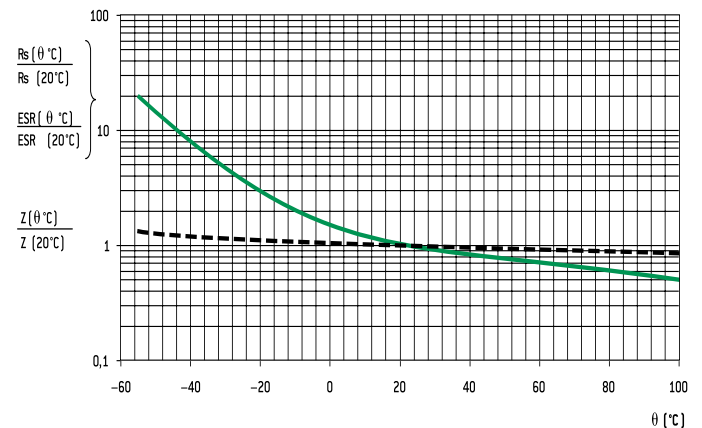

### 4.9.3 Leakage current drift

Versus temperature

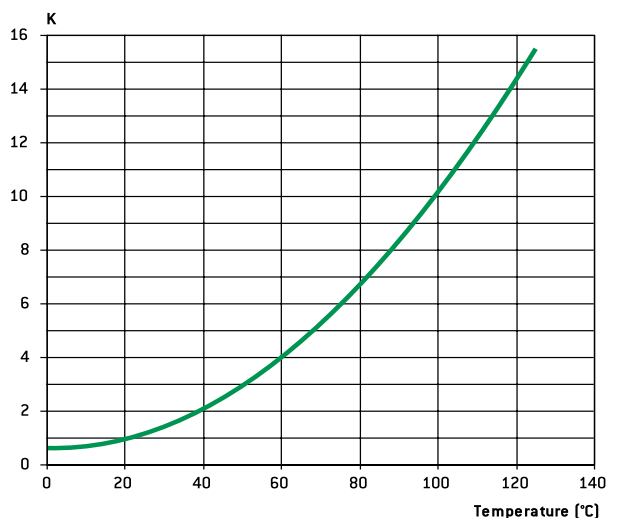

# General technical data

## 5. SPECIFICATION TO APPLY

Electrolytic aluminum capacitors are defined in :

- NF and UTE French national standard
- CECC European specifications
- IEC international specifications

Quality insurance procedures are described in these specifications.

	French	European	International
Generic specification Fixed capacitors	NF C 83 100	CECC 30 000 EN 130 000	IEC 60 384 -1 QC 300 000
Sectional specification Electrolytic aluminum capacitors	NF C 83 110	CECC 30 300	IEC 60 384 - 4 C 300 300
Blank deta II specification - Electrolytic aluminum capacitors with non solid electrolyte /	UTE 83 110	CECC 30 301	IEC 60 384 - 4 -1 QC 300 301
Blank deta II specifications	CECC 30 301- 017 to CECC 30 301- 062 C0 31 to C0 55	CECC 30 301- 017 to CECC 30 301- 062 CECC 30 301- 802 to CECC 30 301- 811	

## 6. ENDURANCE TESTS / LIFE TIME

### 6.1. STANDARD ENDURANCE TEST

at max category temperature :

Temperature	Endurance test			
	Grade I - Long life			Grade II - General purpose
	10 000 h	5 000 h	2 000 h	1 000 h
125°C			•	
105°C		•	•	•
85°C	•	•	•	•

Standard endurance tests do not exceed 2000 hours at 125°C. However, present EXXELIA<sup>SIC SAFCO</sup> technologies concerning liquid electrolytes have led to endurance tests up to 5000 hours at 125°C (PRORELSIC 125 - FELSIC 125 RS) and even 20000 hours at 125°C (PRORELSIC 145 - ALSIC 145)

### 6.2. PERFORMANCE REQUIREMENTS ON STANDARD ENDURANCE TESTS.

Permissible capacitance drift  $\Delta C/C$  (%)

Permissible increase factors on  $\tan\delta$ , ESR, Z and II initial values

$U_R$	Endurance test			
	Grade I			Grade II
	10 000 h	5 000 h	2 000 h	1 000 h
6,3 V			+15 -30	+25 -40
10 V - 35 V	+15 -20	± 15	± 15	± 30
40 V - 160 V	± 15	± 15	± 15	± 30
> 160 V	± 15	± 10	± 10	± 15

	Endurance test			
	Grade I			Grade II
	10 000 h	5 000 h	2 000 h	1 000 h
$\tan\delta$ or ESR (1)	1,5	1,3	1,3	1,5
Z (2)	3	2	2	3
II	Standard values			

(1)  $\tan\delta$  or ESR : for initial value, take standard value.

(2) Z : for initial value, take specified value (see data sheet ).

Specific requirements can be taken into consideration with regards to initial values of dissipation factor or equivalent series resistance and impedance.

## 6.3. FAILURE CRITERIA FOR ELECTROLYTIC CAPACITORS.

Failure criteria are defined in CECC 30 301

- Non measurable defaults leading to complete failure.
- Measurable defaults leading to adjustment losses of the load circuit (failure due to variations).

### 6.3.1. Non measurable defaults.

They might be summed up as :

- Open circuit
- Short circuit
- Operation of pressure relief device
- Severely damaged insulation
- Unusable terminations

### 6.3.2. Measurable defaults.

Variations exceeding the values given below characterize a default.

- Capacitance drift  $\Delta C/C$  (%) : 3 times the limit for standard endurance testing or 50 % (whichever is the smallest).
- $\tan\delta$  or ESR : 3 times standard max initial values.
- Z : 3 times standard max initial values.
- II : initial limit (under load conditions).

Specific requirements can be taken into consideration with regards to lower drifts.

## 6.4. INFLUENCE OF MAIN PARAMETER ON OPERATIONAL LIFE.

### 6.4.1. Temperature.

The capacitors operational life is highly dependent upon its internal temperature  $\Theta_i$  and therefore upon the ambient temperature and the ripple current.

Knowing ESR and dissipated power values (§ 6.4.3.) one can figure out, the internal temperature rise and then determine the capacitors expected life.

With present high boiling point electrolytes (§ 8.6)

$\Theta_i \text{ max} = 125 \text{ to } 185^\circ\text{C}$  depending on styles.

### 6.4.2. Ripple current.

The ripple current flowing through the capacitor increase the internal temperature through power dissipation.

Standards define the permissible current at 100 Hz and generally consider a temperature rise of 5 to 10°C of max category temperature.

Current waveforms and frequencies make it difficult to clearly determine the capacitors internal temperature rise, which defines the operational life.

Experiments confirm following relationship :

$$\Theta_i = \Theta_a + (\Theta_c - \Theta_a) K$$

Where :

- $\Theta_i$  = Internal hot spot temperature
- $\Theta_a$  = Ambient temperature
- $\Theta_c$  = Case temperature
- K = Parameter depending upon case diameter and cooling
  - $\emptyset \geq 51 \text{ k} = 2^{\pm 0,5}$
  - $\emptyset < 51 \text{ k} = 1,5^{\pm 0,5}$  (air cooling - 0,2 m/s)

# General technical data

### r.m.s. value according to current waveform.

Function	Mean value	R.m.s. value	Function	Mean value	R.m.s. value	Function	Mean value	R.m.s. value
	$A (t_0/T)$	$A \sqrt{t_0/T}$		$A/2$	$A \sqrt{3}$		$2A/\pi$	$A / \sqrt{2}$
	$A (t_1/T)$	$A \sqrt{2t_1/3T}$		$2A/\pi (t_0/T)$	$A \sqrt{t_0/2T}$		$A/2$	$A / \sqrt{3}$
	$A/2 (t_0/T)$	$A \sqrt{t_0/3T}$		$A/2 (t_0/T)$	$A \sqrt{t_0/3T}$		0	A

### 6.4.3. Dissipated power versus case dimension

For calculations of ripple currents, considering an internal temperature rise of 10°C

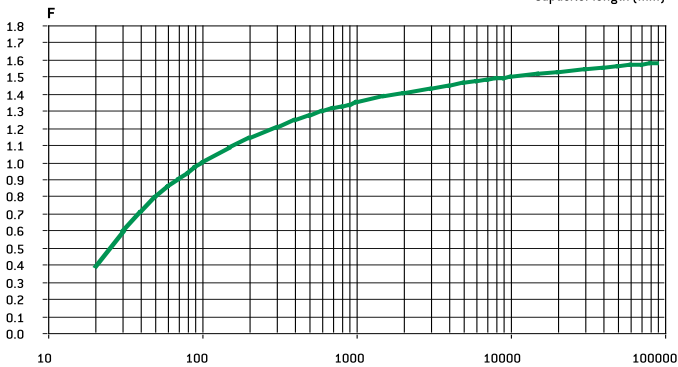
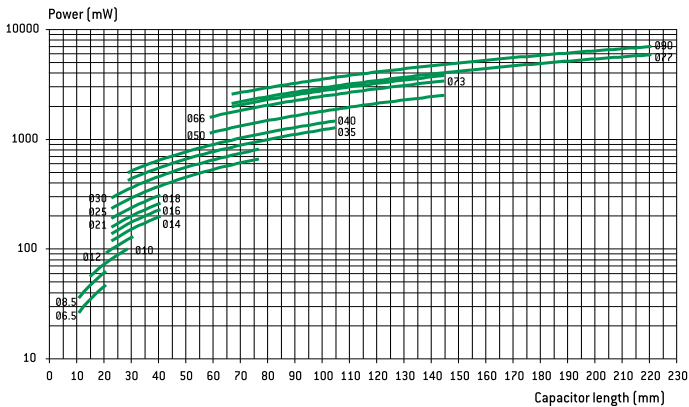

$P = ESR \cdot I^2$

P = Dissipated power (mW)

( $\Theta_i - \Theta_a = 10^\circ\text{C}$ )

ESR : Equivalent series resistance (100 Hz 20°C)

I : Ripple current (r.m.s. value at 100 Hz)

For different frequencies from 100 Hz, I must be multiplied by the factor F, according to above chart. :

### 6.4.4. Thermal resistance Rth and air cooling

Rth is static thermal resistance (without cooling) between capacitor central hot spot and ambient temperature measured at a distance of one capacitor diameter

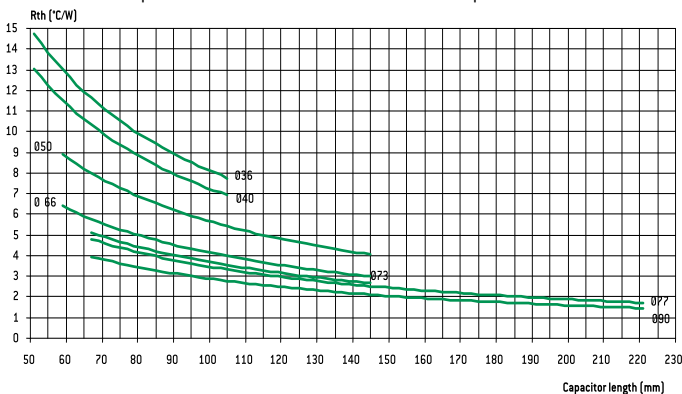

Forced or not cooling air can lead to a significant decrease of these values.

Consequently, r.m.s. ripple current can be increased as a function of air cooling speed :

$\emptyset$ (mm)	$\leq 0,5$ m/s	1 m/s	2 m/s	3 m/s	$\geq 4$ m/s
66 - 90	1~	1,1 1~	1,2 1~	1,25 1~	1,3 1~
36 - 51	1~	1,2 1~	1,4 1~	1,45 1~	1,5 1~

This parameter shall be applied to one capacitor alone.

For capacitors in bank, ambient temperature must be strictly equal around all capacitors.

### 6.4.5. Quality guaranty

We guarantee products manufactured during 2 years from the data of shipment against defaults of material and assembly.

This guaranty can be involved by the buyer only if our products are used within normal conditions, always according to the state of the art and taking in account storage conditions.

The equipment design should take into consideration possible failures of our capacitors and related effects in order to avoid them.

Guaranty is not applicable for damages occurred by surge voltage, irregular use, polarity inversion or maintenance default.

Guaranty is exclusively limited to the replacement of individual defective capacitors within the terms of delivery. This rule applied to all cases and particularly to any further consequence of failures.

### 6.4.6. Reliability

Failure rate :

Failure rate  $FR = \frac{\text{Number of components tested} \times \text{test duration}}{\text{Number of failures}}$

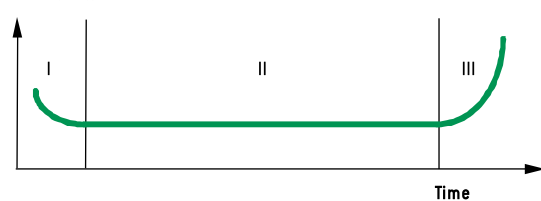

Number of failures

Failure rate is measured in FIT (failure in time =  $10^{-9}$  / hour).

The failure rate is set up during the life time of the capacitor (phase II)

I. Early failure phase (generally excluded during ageing process).

II. Operational life time of the capacitors

III. End of life

# General technical data

Mean time between failures MTBF = 1/FR measured in years

Range	Failure rate for a failure percentage not exceeding 1% with a confidence level of 60 %
FELSIC 85 >350 V FELSIC CAPAX > 350 V SNAPSIC - SNAPSIC CAPAX > 350 V SNAPSIC 4P > 350 V PROMISIC 031 Ø = 6,5 SICAL CO 42 - SICAL > 350 V	50 FIT - (MTBF = 2280)
FELSIC 037 - 039 FELSIC 85 ≤ 350 V FELSIC CAPAX ≤ 350 V CUBISIC CI FRS SNAPSIC 105 - SNAPSIC 105 4P SNAPSIC 105 LP - SNAPSIC HV SNAPSIC - SNAPSIC 4P ≤ 350 V SNAPSIC CAPAX ≤ 350 V ALSIC IR - ALSIC 145 - ALSIC HV - VACSIC 150 - VACSIC SICAL CO 42 - SICAL ≤ 350 V PRORELSIC 125 Ø = 6,5 RELSIC 033 PROMISIC 031 Ø > 6,5	25 FIT - (MTBF = 4560)
FELSIC 125 FRS - SNAPSIC 125 FELSIC HV - FELSIC 105	10 FIT - (MTBF = 11410)
PRORELSIC 125 Ø > 6,5 PRORELSIC 145	5 FIT - (MTBF = 22820)

Multiplying factor of FR with voltage and temperature

Factor	Temperature [°C]							
	≤ 40	50	60	70	85	105 (1)	125 (1)	145 (1)
Factor	1	1,5	2,3	3,4	6,3	14	32	72

(1) Only for permitted capacitors

Factor	Percentage of rated voltage (2)		
	100 %	80 %	50 %
Factor	1	0,8	0,5

(2) This voltage has to be constant

Environment	Without vibration		Ground with vibrations or mobile			
	Ground, fix Controlled air	Ground, fix	PRORELSIC SNAPSIC 20 g FELSIC 20 g	FELSIC 10 g PROMISIC SICAL Ø ≤ 14	CI FRS - SNAPSIC RELSIC SICAL Ø > 14	ALSIC
Factor	1	2	2	4	6	12

## 7. MANUFACTURING FLOW CHART

Process controls

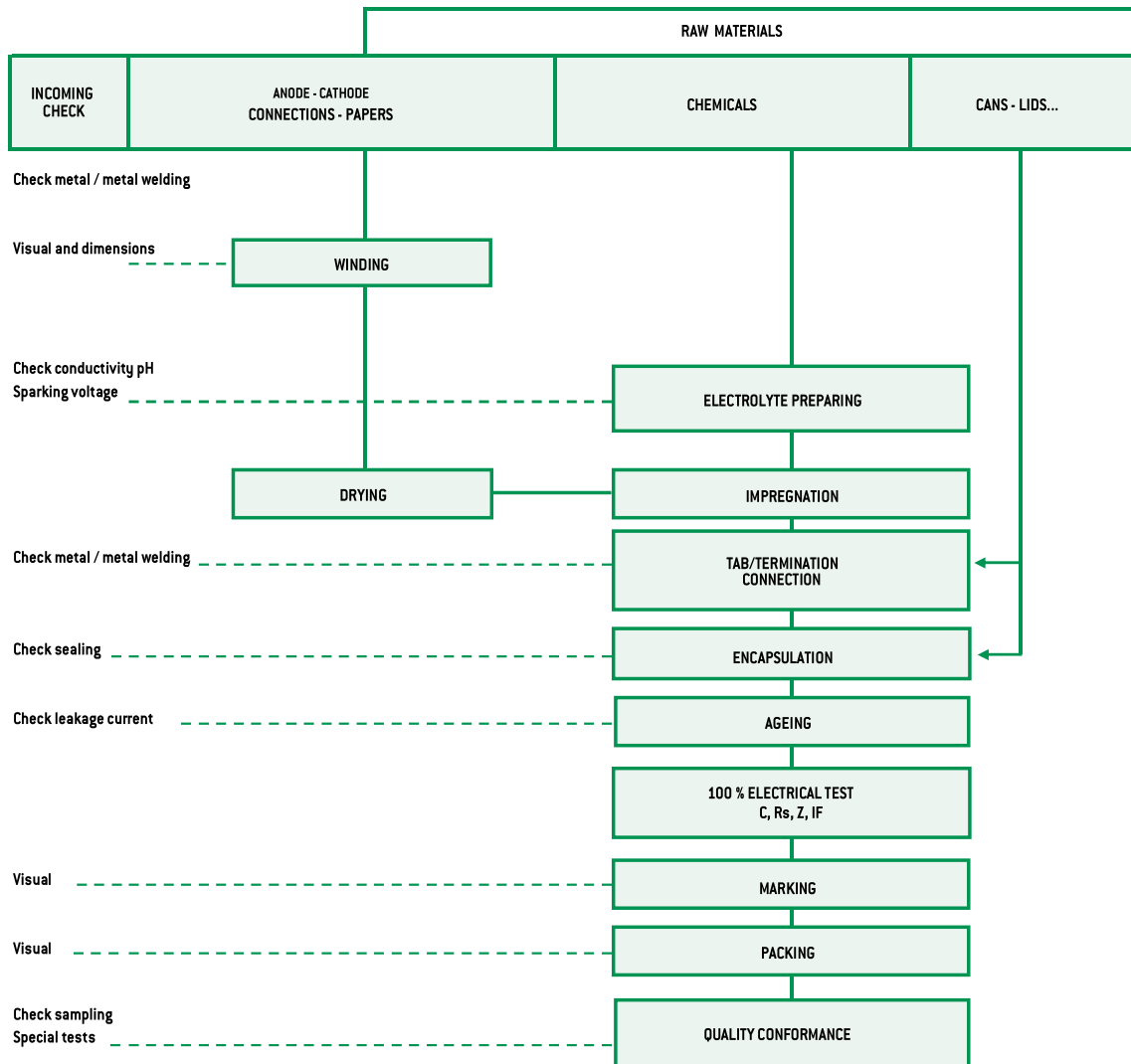



# General technical data

## 8. INFORMATION ON APPLICATION

### 8.1. CLEANING SOLVENTS

Use aliphatic alcohols, such as denatured ethyl alcohol, isopropanol, or butylacetate, or else alkaline diluted solutions. Avoid incompatible solvents (halogenous for example).

### 8.2. SHELF LIFE

There is no electrical characteristics variation for long periods of storage except leakage current which can increase.

It is caused by chemical reactions between the dielectric alumina and the electrolyte. These reactions are reversible when switched on. Capacitors can generally be stored at temperature between  $-5^{\circ}$  and  $+50^{\circ}\text{C}$  without reforming for the following periods of time :

- For  $U_R \leq 100\text{ V}$ , storage time : ..... 5 years  
(up to 10 years under specific conditions)
- For  $100\text{ V} < U_R \leq 360\text{ V}$  storage time : ..... 3 years
- For  $360\text{ V} < U_R < 500\text{ V}$  storage time : ..... 1 year
- For  $U_R \leq 500\text{ V}$ , storage time : ..... 6 months

Generally when these periods are overstepped, one hour at rated voltage causes the decrease of leakage current under the specified limits. An other way to avoid this leakage current increase problem is to always limit available power through capacitor during first seconds or minutes after storage or transport, according to the following chart :

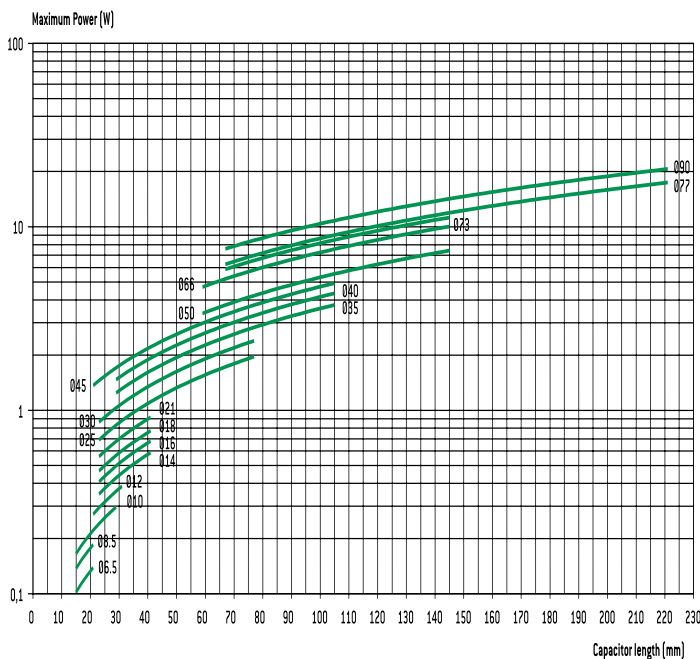

### 8.3. LOW PRESSURE RESISTANCE

EXXELIA <sup>SIC SAFCO</sup> capacitors can be used with ambient low pressure decreasing up to 10 mbar (altitude 28000 m – 92000 feet).

### 8.4. MOUNTING SCREW TERMINALS CAPACITORS (FELSIC)

Capacitors may be used vertically (terminals on top) or horizontally. When used horizontally, the following position in relation to the safety vent, is recommended :

Mounting capacitors in series may be used for operating voltage exceeding  $U_R$ . See FELSIC in bank

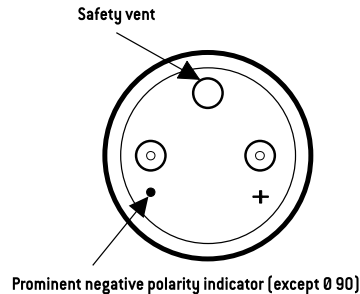

### 8.5. MOUNTING SOLDER TYPE CAPACITORS.

They may be used in any position. During mounting, avoid applying excessive force to capacitor pins or wires. There is a risk of damaging internal connections. After soldering and for the same reasons, do not try to move the capacitor's body.

### 8.6. ELECTROLYTES : SAFETY RULES.

Electrolytes used in EXXELIA <sup>SIC SAFCO</sup> capacitors are manufactured by EXXELIA <sup>SIC SAFCO</sup>. Main solvents are generally  $\gamma$  butyrolactone and ethylene glycol, very stable high boiling point solvents. Ionic conductive salts in electrolyte induce a very weak acidity (pH 5 to 7).

### 8.7. ENVIRONMENT.

- There is no possibility to produce gaseous emissions of nitrogen oxides or liquid emissions of nitrites or nitrates during the manufacture process.
- There is no possibility to produce liquid emissions or salts coming from dangerous metals such as mercury, hexavalent chromium or cadmium and from poisons such as arsenic or cyanides.

Accessories not made in aluminum, ring, screw, are also plated in anticorrosion processes without cadmium.

EXXELIA <sup>SIC SAFCO</sup> is always involved in this security field particularly in using whenever it's possible chemicals for electrolyte, without well-known risks.

- Dimethylformamide (DMF) dangerous solvent forbidden in several uses is completely excluded by EXXELIA <sup>SIC SAFCO</sup>, since 1990.
- There is no halogen compound such as chlorofluorocarbon (CFC or FCKW in german) or polychlorobiphenyl (PCB-Pyralene) or pentabromodiphenylether or octabromodiphenylether.

There is neither benzene, toluene or phenyl compound nor explosive such as picric acid, nor asbestos in plastic covers.

All the capacitors made by EXXELIA <sup>SIC SAFCO</sup> since 1991, can be scrapped or used in raw materials recycling processes with-out special care.

EXXELIA <sup>SIC SAFCO</sup> aluminum capacitors with non solid electrolyte are particularly suitable for different kinds of environment taking in account severity increasing laws.

European directives 2003/11/EC, 2002/96/EC (WEEE) and 2002/95/EC (RoHS) applies to all EXXELIA <sup>SIC SAFCO</sup> capacitors including every solder type, manufactured with pure tin coated pins or wires, since at least January 2006.

EXXELIA <sup>SIC SAFCO</sup> capacitors do not contain any carcinogen, mutagen and substance toxic for reproduction in accordance with 1907/2006/EC (REACH) European directive target.

# Mounting and insulating parts

## STUD FIXING : FELSIC BD

Steel nut, spring washer and insulating washer are delivered loosely with the capacitor.

### STANDARD MOUNTING WITH :

Insulating washer and steel nut

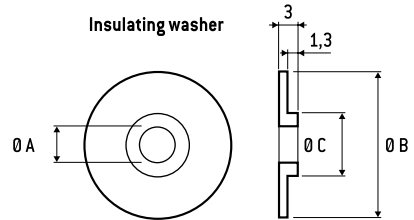
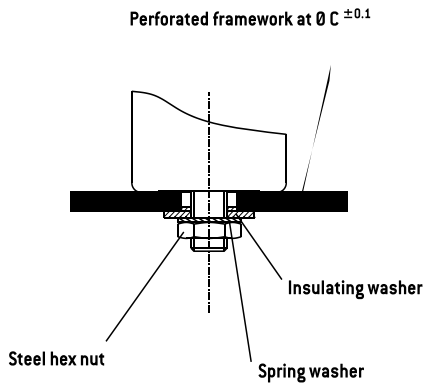

Ø Capacitor	Dimension (mm)				Code
	M	Ø A	Ø B	Ø C	
36	8	8,4	25	18,5	A 691060
51 - 77	12	12,5	30	21,5	A 691061
90	12	12,5	35	21,5	A 691062

Insulating plastic nut with or without insulating washer

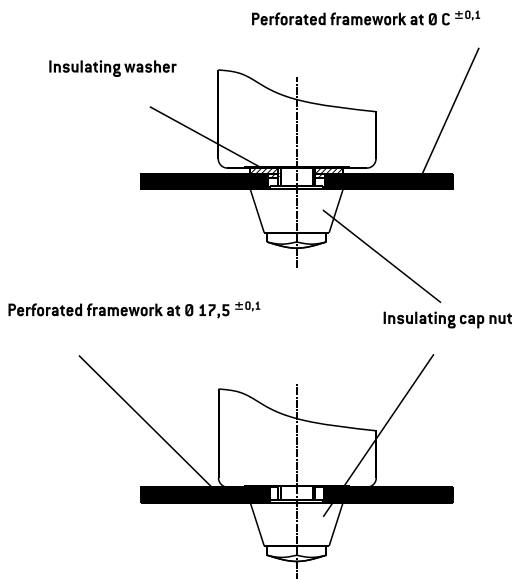

Insulating cap nut

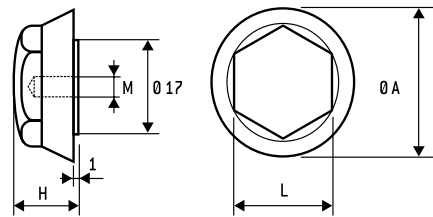

M	Dimension (mm)				Max. torque	Code
	Ø A	H	L			
8	25	15	17	3 Nm	A 691070	
12	30	20	19	7 Nm	A 691071	

## Ring - clip mounting : FELSIC LP

Ring clips shall be ordered separately.

Tightening screws and nuts are supplied loosely.

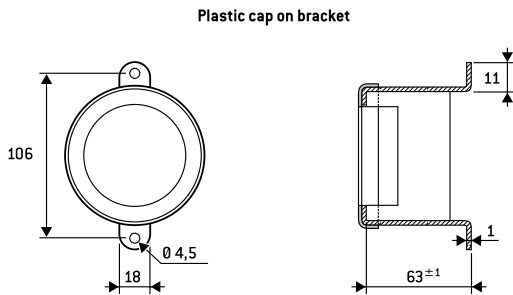

FELSIC 85 LP FELSIC 105 LP	Code
Metal bracket	A691055
Plastic cap	A691065

# General technical data

## Ring - clip mounting : FELSIC BC

Ring clips shall be ordered separately.

Tightening screws and nuts are supplied loosely.

### FELSIC BC - Metal ring-clips

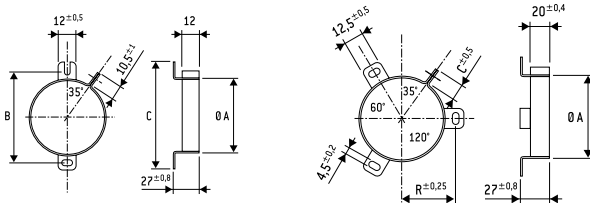

Ø A Cap.	B	C	Code	Ø A Cap.	B	C	Code
36	54	63	A 691901	51	33,5	11,8	A 691905
				66	39	10,5	A 691913
				73	44	10,5	A 691914
				77	44,5	10,5	A 691907
				90	53,3	11,8	A 691915

## Stirrup mounting : CUBISIC LP

Stirrups shall be ordered separately.

Tightening screws and nuts are supplied loosely

Salt mist endurance of screws and mounting accessories :  
minimum 96 h (IEC 600 68-2-11)

### CUBISIC /CUBISIC LP - Metal bracket

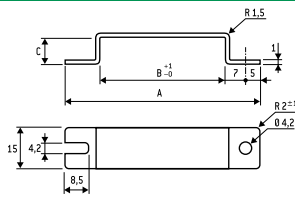

Ø A Cap.	A	B	C	Code
45x12	69	45	10	A 691057
35x16	59	35	14	A 691059

## PACKAGING

### 1. PACKAGING AND WEIGHT UNITS.

#### 1.1. Capacitor with screw terminals

Case dimensions				Unit weight *
Ø	H			(g)
36	47	52	53	70
36	60			79
36	80	81		100
36	104	105		120
51	47			80
51	62	63		105
51	81	82		190
51	104	105		260
51	112			270
51	144			370
66	104	105		430
66	112			460
73	104	112		600
73	144			680
77	104	105		620
77	144	145		860
77	200			1300
77	220	221		1400
90	67			600
90	144	145		1400
90	200			1800

\* Unit weight = typical values

Possible variations of = ± 25 % according to different voltage and capacitance.

#### 1.2. Radial solder types

Case dimensions		ALSIC	SNAPSIC	Case dimensions		ALSIC	SNAPSIC
Ø (mm)	H (mm)	Weight* (g)	Weight* (g)	Ø (mm)	H (mm)	Weight* (g)	Weight* (g)
10	16	1,8		35	30		50
				35	40		50
12,5	21	4,5		35	45		52
12,5	24	5		35	50		60
				35	75		95
16	25	8,2		35	100		125
22	25		15	40	40		65
22	30		17	40	50		100
22	40		18	40	75		130
				40	100		170
25	25		17	45	21		50
25	30		20	45	25		60
25	35		22	45	30		73
25	40		25	45	35		85
25	45		28	45	45		110
25	50		30	45	75		180
				45	100		240
30	25		28				
30	30		30				
30	35		30				
30	40		40				
30	45		45				
30	50		50				

Case dimensions			CUBISIC
I	L	H	weight (g)
35	35	16	30
35	50	16	40
45	35	12	30
45	50	12	45
45	75	12	60

\* Unit weight = typical values

Possible variations of = ± 25 % according to different voltage and capacitance.

#### 1.3. Axial types

Case dimensions		PRORELSIC	PRORELSIC	SICAL CO 42
Ø (mm)	H (mm)	Unit weight* (g)	PROMISIC (g)	SICAL (g)
6,5	15		1,6	
6,5	19		1,8	1,8
8,5	19		2,3	2,3
10	19		2,8	2,8
10	25		3,5	3,5
10	28		3,8	
12	25		5	
12	30		5,4	5,4
14	30		6,9	6,9
14	41		9,5	
16	30	7,7		7,7
18	35	13,6		
18	40	15,3		15,3
21	40	19,5		19,5
25	40	28		28
25	50	35		35
25	75	56		56

\* Unit weight = typical values

Possible variations of = ± 25 % according to different voltage and capacitance.