

AE09

SINGLE TURN ABSOLUTE OPTICAL ENCODER



PRESENTATION

The AE09 absolute encoder includes EXXELIA GROUP state-of-the-art and proprietary optical technology.

With their very compact design, high reliability and high precision, EXXELIA GROUP miniature encoders meet the requirements of the most demanding applications (Aerospace, Military, Industrial, Medical industry, Oil & mining industry...).

Various output protocols are available in order to match your application.



High temperature
up to +115°C



Shocks/Vibrations
resist



SSI / FSSI
interface



Low profile



High
performances

GENERAL DATA

Resolution	Up to 19 bits
Accuracy	± 1' max.
Maximum rotation speed	300 rpm
Starting torque	≤ 0.2 N.cm
Weight (without cable)	35 g max.

ENVIRONMENTAL DATA

Operating temperature	Up to -55°C to +115°C
Storage temperature	-55°C to +125°C
Sealing	IP 40
Vibrations	20 g, 1.5 mm, 10 Hz to 2 kHz
Shocks	50 g, 1/2 sine, 11 ms

For other specifications, please contact us

DIMENSIONS (in mm)

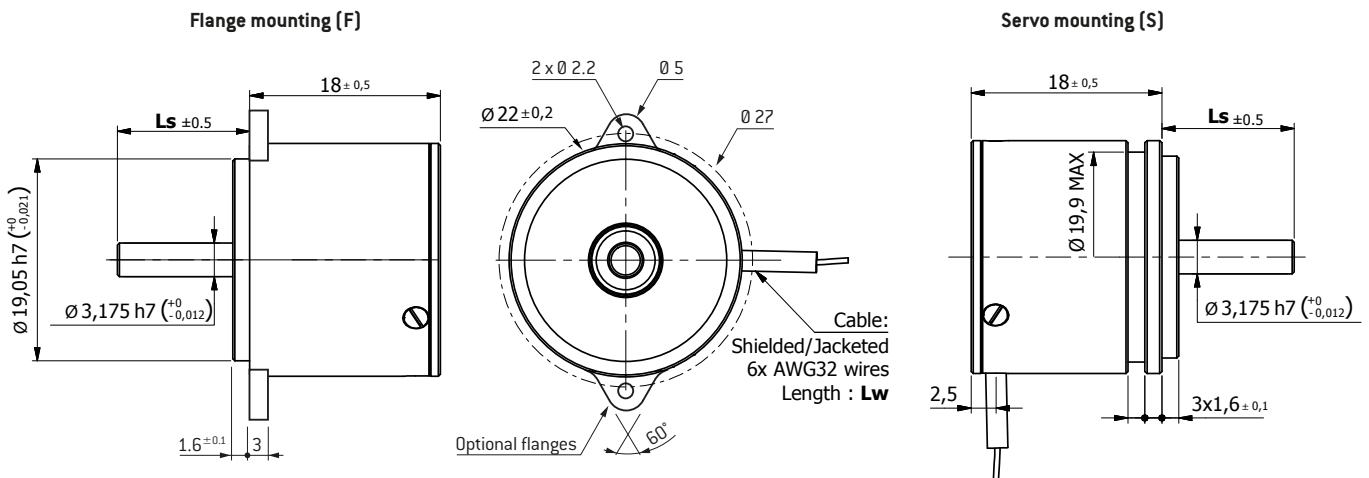

SINGLE TURN ABSOLUTE OPTICAL ENCODER

AE09

STANDARD ELECTRICAL DATA

Power supply	+5 V _{DC} ± 5%
Maximum consumed current	130 mA
Output signals	RS422/485
Maximum operating frequency	2 MHz (SSI) / 4 MHz (FSSI)

For other specifications, please contact us

ELECTRICAL INTERFACE

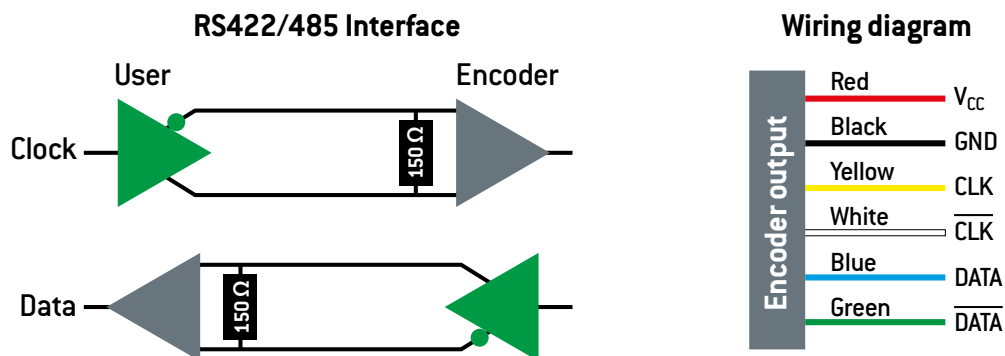

HOW TO ORDER

	Mounting	Resolution	Protocol ¹	Temperature range	Mechanical coupling	Wire length (Lw)	Shaft length (Ls)	RoHS compliance
AE09	•	••	••	••	••	•••	•••	•
	F	13	S1	ST	01	250	125	W
	S	19	FS	MT	02	TBD	TBD	N
				HT	XX			

F: Flange	13 to 16 bits Standard	S1: SSI	ST: Standard temp. -40°C to +85°C	01: Without coupling	250: 250 mm Standard	125: 12.5 mm Standard	W: RoHS compliant
S: Servo	17 to 19 bits Specific	FS: FSSI Standard SSI2 compatible	MT: Medium temp. -45°C to +105°C	02: Standard coupling ¹	TBD: To Be Defined by the customer	TBD: To Be Defined by the customer	N: Non compliant
			HT: High Temp. -55°C to +115°C	XX: Custom coupling ²			

1: Please refer to «Encoder Handbook» available on EXXELIA GROUP website.

2: For further information, please contact us.

Contactless Position Sensors general information

1. INTRODUCING EXXELIA GROUP ENCODERS

Encoders are sensors that generate digital signals in response to movement. Encoders come with two outlines: rotary and linear. Both types sense mechanical motion and translate the information (velocity, position, acceleration) into useful data.

A contactless technology

To address demands for longer service life and with its strong track record in contact technology position sensors (potentiometers), Electromechanical Solutions SBU has been developing own-brand contactless sensors for nearly 10 years. These sensors are absolute and incremental optical encoders, magnetic technology and inductive sensors.

Absolute optical or magnetic encoders: absolute optical encoders are position sensors that use optical signals to identify an absolute angular position. The EXXELIA GROUP encoders offer very high performance levels for a very small footprint:

- high precision (<30 arcsec),
- high resolution (up to 21 bits),
- highly thin (10mm),
- EMI EMC compatibility

Incremental optical or magnetic encoders: absolute optical encoders are position sensors that use optical signals to identify an absolute angular position. Incremental encoders have to be initialized by a first turn to produce an absolute position.

Applications: Aeronautics, Defense, Railway, Medical, Oil exploration, Telecommunications

EXXELIA GROUP encoders can also be easily combined with other functions like Slip rings or rotary joints (FORJ, HF...) in complete proprietary systems.

2. SENSING TECHNOLOGY

Encoders can use either optical or magnetic sensing technology.

Optical sensing provides high resolutions, high operating speeds, and reliability, long life operation in most environments.

Magnetic sensing, often used in rugged applications provides good resolution, high operating speeds, and maximum resistance to dust, moisture, and thermal and mechanical shock.

Optical Encoders: principles

Optical encoders' principle of operation is relatively simple; a light source (photo-emitter) sends light through a mobile disk or scale, consisting of a succession of opaque and transparent parts, on photo-receivers. When the disk or the scale moves, it

conveys or alternatively blocks the light emitted by the source; the scale or the disk is acts in fact as a beam switch. The photo-receiver generates an electrical signal, which is processed and analyzed in order to allow encoding the system position.

An optical encoder consists of three major subsets:

- Encoder housing.
- Optical block: consisting of an emission system, an optical coding system and a detection system. It generates the position function signal.
- Electronics block: it allows amplifying, converting and processing the signal.

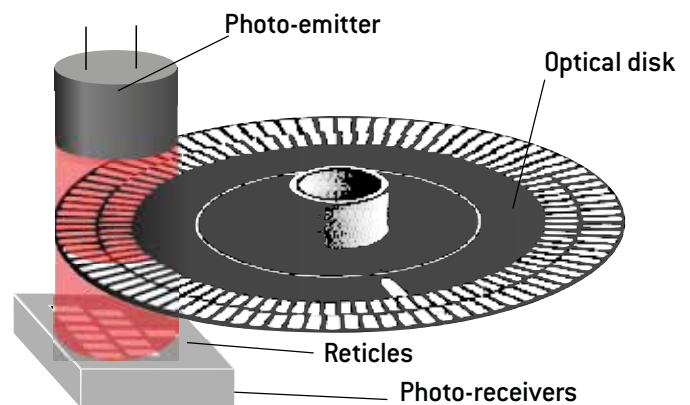

Figure 1: Incremental principle

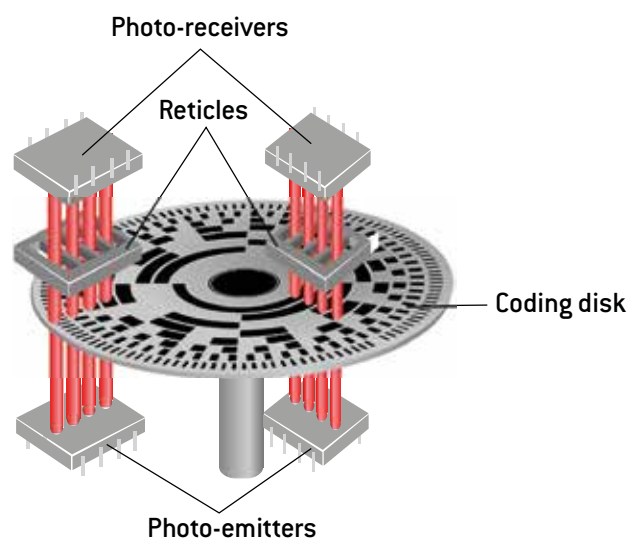

Figure 2: Absolute principle

Contactless Position Sensors general information

Optical encoders use a glass disk with a pattern of lines deposited on it, a metal or plastic disk with slots (in a rotary encoder), or a glass or metal strip (in a linear encoder). Light from a LED shines through the disk or strip onto one or more photodetectors, which produce the encoder's output.

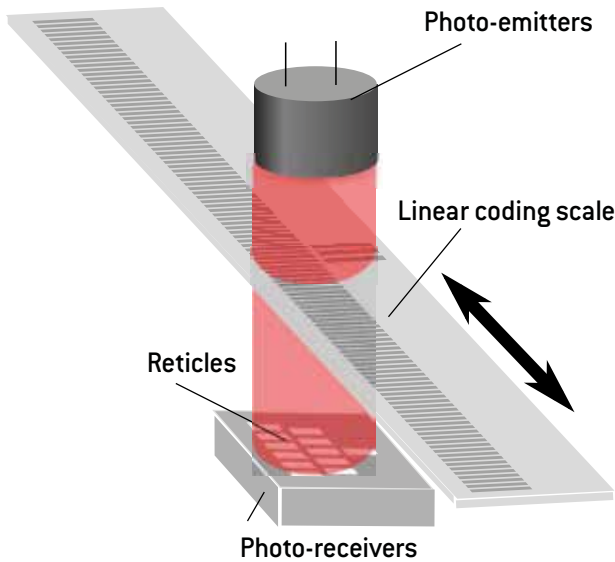

Figure 3: Linear principle

3. MAGNETIC ENCODERS: PRINCIPLES

The position sensors which use the detection of a magnetic field generally work following the same principle:

A magnetic field is generated thanks to a permanent magnet or an electromagnet. The distribution in the space of this magnetic field is not homogeneous. Depending on the relative positions of the magnetic source, the sensors cells and a possible ferromagnetic third element, the magnitude of the field will be different. The measured value is then analysed as a function of the specific geometry in order to recover the information of position.

Among magnetic encoders we can distinguish several technologies which are using this principle to convert magnetic field into a physical quantity useful in electronic devices (typically current or tension). The most common are inductive encoder, magneto-resistive encoder and Hall effect encoder.

Magnetic encoders are typically robust and non-sensitive to environmental stress like shocks, vibrations, and chemical substances. In order to protect the measurement against a variation of the external magnetic field (especially next to motors), it is possible to add a magnetic shielding with specific materials and to carry out differential measurements.

Magnetic encoders constitute miniature long-life cost-effective sensors. Magnetic sensing technology is very resistant to dust, grease, moisture, and other contaminants common in

industrial environments, as well to shock and vibrations.

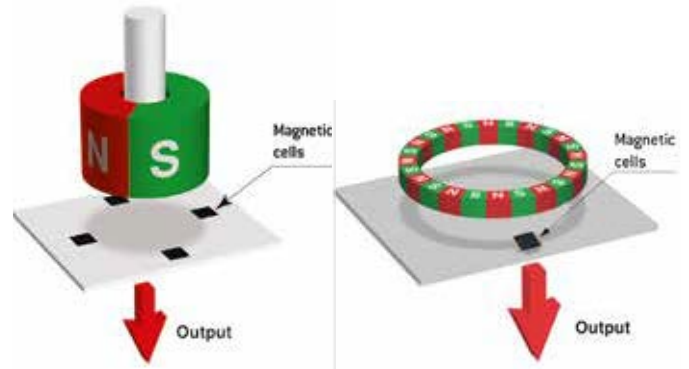

Fig. 4a

Fig. 4b

Figure 4: Magnetic Sensor principles:
a) On axis technology with a bipolar magnet
b) odd axis technology with a multipolar ring

4. ABSOLUTE OR INCREMENTAL CODING?

INCREMENTAL CODING

Incremental encoders provide a specific number of equally spaced pulses per revolution (PPR) or per inch or millimeter of linear motion.

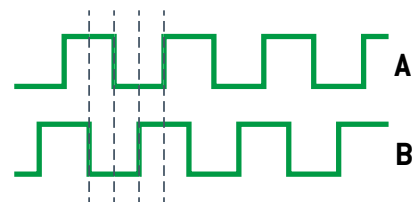

Figure 5: A and B quadrature signals

For applications that do not require detection sensing, a single channel output is used. But in most cases, two channels A and B, 90 electrical degrees out of phase are used. Those two channels allow a detection of the direction of motion [See Figure 6]. This is useful for processes that can reverse, or must maintain steady position when standing still or mechanically oscillating.

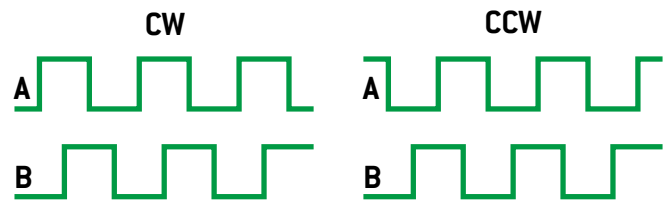

Figure 6: Determination of the direction of movement

The quantity of positions that can be detected depends on electronic processing from channels A and B (see Figure 7). In the case the disk has N periods or "bars":

If processing system only detects leading (or trailing) edges of channel A (or B), then the resolution is equal to the number N.

Contactless Position Sensors general information

If the system detects leading and trailing edges of channel A (or B), or if it detects leading or trailing edges of channels A and B, then the resolution is equal to $2N$.

If processing system detects leading and trailing edges of the channels A and B, then the resolution is $4N$.

In some configurations, it is even possible to electronically interpolate more precisely this signal and achieve up to $50N$ resolution.

To determine a position, incremental encoders need an initialization step that is a lap or a movement to find the “zero” reference or home position. After this step, each pulse will be accumulated into a counter. In case of a power interruption or corruption by electrical transients, the count is lost and the initialization step should be done again.

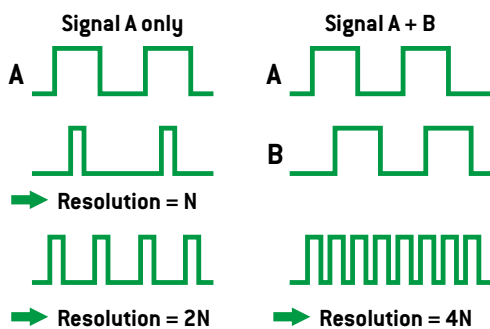

Figure 7: Resolution of incremental encoders

This “zero” or home position may be output as a signal known as the “marker,” “index,” or “Z channel.”

Incremental encoders are principally used in applications where relative movement is required, such as machine or process control, robotics...

ABSOLUTE CODING

Absolute coding is basically different than incremental coding. Every position of an absolute encoder is unique. Unlike an incremental encoder, where position is determined by counting pulses from a zero mark or home base, the absolute encoder reads a system of coded tracks to establish position information.

Absolute encoders do not lose position when power is removed. Since each position is unique, true position verification is available as soon as power is up. It is not necessary to initialize the system by returning to home base.

An absolute encoder’s resolution is defined as the number of bits in its output word. This output can be in natural binary or in gray code, which produces only a single bit change at each step to reduce errors.

Absolute encoders will be used when the measurement is critical and the application cannot afford an initializing step for

“zeroing” (seekers, flight commands, radar mechanics...).

How to easily understand the difference between incremental and absolute encoders?

A well-known image is that the difference between incremental and absolute encoders is similar to the difference between a stop watch and a clock. A stop watch measures the incremental time that elapses between its start and stop, just like an incremental encoder will provide a known number of pulses relative to a movement. If you knew the actual time when you started the watch, you can tell what time it is later by adding the elapsed time value from the stop watch. For position control, adding incremental pulses to a known starting position will measure the current position. When an absolute encoder is used, the actual position will constantly be transmitted, just as a clock will tell you the current time.

5. SSI / FSSI

SSI is a synchronous, point to point, serial communication channel for digital data transmission. Synchronous data transmission is one in which the data is transmitted by synchronizing the transmission at the receiving and sending ends using a common clock signal. Since start and stop bits are not present, this allows a better use of data transmission bandwidth for more message bits and makes the whole transmission process simpler and easier. The clock needs its own bandwidth and should be included when determining the total bandwidth required for communication between the two devices.

In general, as mentioned earlier, it is a point to point connection from a master (Microcontroller) to a slave (rotary encoders). The master controls the clock sequence and the slave transmits the current data/value through a shift register. When invoked by the master, the data is clocked out from the shift register. The master and slave are synchronized by the common clock of the controller.

The CLOCK and DATA signals are transmitted according to RS-422 standards. RS-422, also known as ANSI/TIA/EIA-422-B, is a technical standard that specifies the electrical characteristics of the balanced voltage digital interface circuit. Data are transmitted using balanced or differential signaling and the CLOCK and DATA lines are basically twisted pair cables.

FSSI is the same synchronous interface but includes a start bit and is more flexible for other options (Alarm bit, ID encoder....). The maximum bandwidth is 4 MHz.