

Ceramic Capacitors



Standard
& Custom



EXXELIA 

Ceramic Capacitors



A Worldwide presence

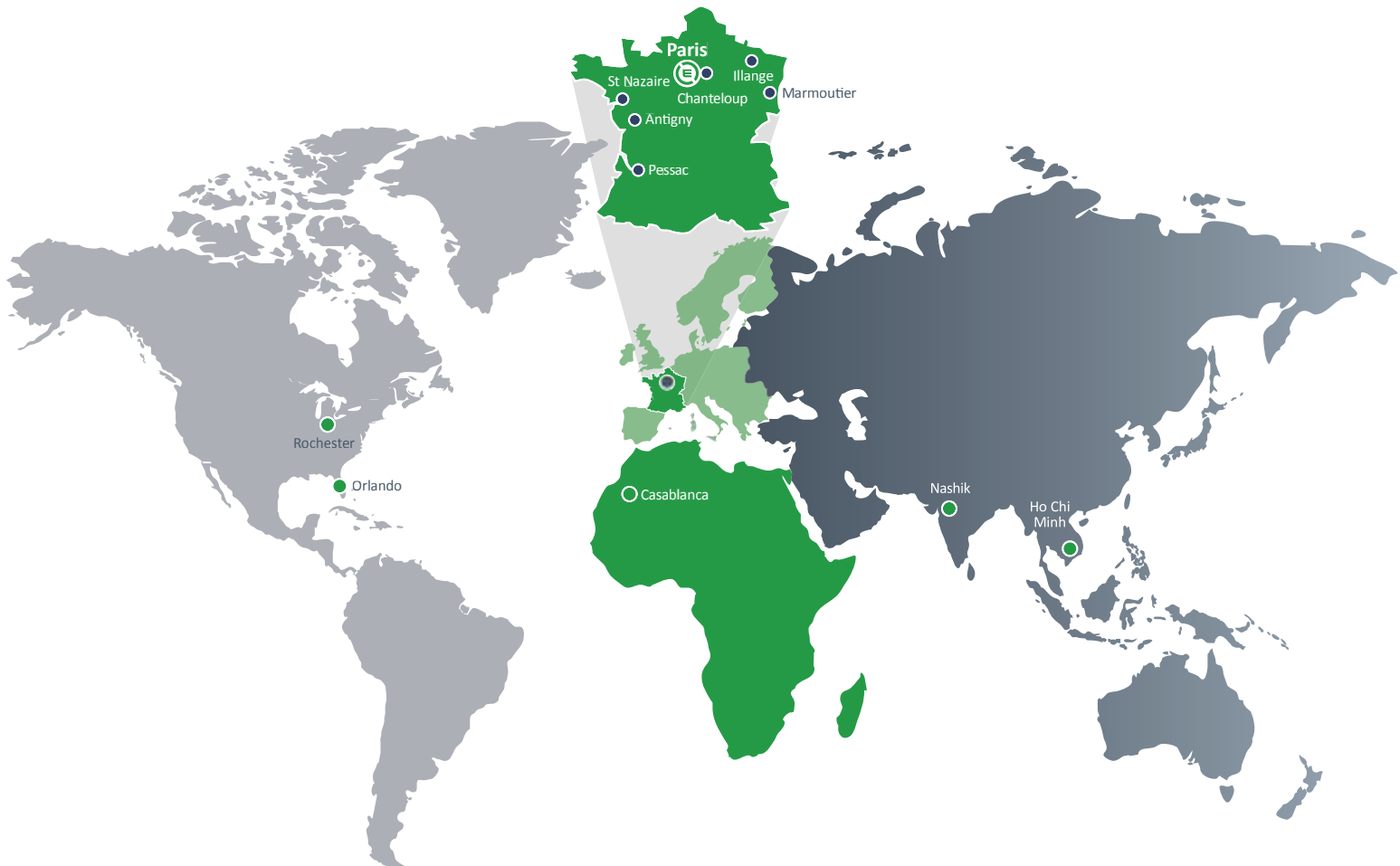

Specifications are subject to change without notice. All statements, information and data given herein are presented without guarantee, warranty or responsibility of any kind, expressed or implied.

General Information

MATERIALS EXPERT

For 50 years and as a market leader, EXXELIA's comprehensive knowledge of the materials properties and performances have enabled us to design capacitors in Porcelain, NPO, BX, 2C1, BP, X7R and –2200ppm/°C ceramics.

CUSTOM DESIGNS

Our catalog products don't meet your application?

Based on the valuable experience accumulated over the design of 2,000+ specific ceramic capacitors, you can trust EXXELIA to define a qualitative custom solution in a time effective manner.

NO OBSOLESCENCE

Choosing a standard or custom EXXELIA product means you won't have to worry about obsolescence.

TYPICAL APPLICATIONS

- Aerospace & Defense: cockpit panels, flight control, radio systems, missile guidance systems...
- Space: military and commercial satellites, launcher...
- Medical: MRI, external defibrillators, implantable devices...
- Telecommunications: base stations...
- Oil and gas: drilling tools, MWD, LWD, wellheads...

ISO 9001 AND AS9100C

Quality is at the core of Exxelia's corporate culture. Each sites has its own certifications.

CERTIFICATIONS

Capacitors manufactured by EXXELIA comply with American and European standards and meet the requirements of many international standards. For Space qualified parts (ESA QPL), please refer to our catalog «Ceramic capacitors for Space applications».

QUALITY & RELIABILITY

EXXELIA is committed to design and manufacture high quality and reliability products. The test cycles reproducing the most adverse operating conditions over extended periods (up to 10 000 hours) have logged to date well over 5.10^9 hours/°C/component.

Failure rate data can be provided upon request.

CONFLICT MINERALS

EXXELIA is committed to an approach based on «Conflict Minerals Compliance». This US SEC rule demands complete traceability and a control mechanism for the mineral procurement chain, encouraging importers to buy only «certified» ore.

We have discontinued relations with suppliers that procure from the Democratic Republic of the Congo or an adjoining country.

ENVIRONMENT

EXXELIA is committed to applying a robust environmental policy, from product design through to shipment. To control its environmental footprint and reconcile this with the company's functional imperatives, our environmental policy provides for the reduction or elimination of hazardous substances. We also focus on compliance with European Union directives and regulations, notably REACH and RoHS.

RoHS COMPLIANCY

SMD CAPACITORS

The capacitor terminations are generally protected by a nickel barrier formed by electrolytic deposit. This barrier gives chip capacitors leaching performance far exceeding the requirements of all applicable standards. The nickel barrier guarantees a minimum resistance to soldering heat for a period of 1 minute at 260°C in a tin-lead (60/40) or tin-lead-silver (62/36/2) bath without noticeable alteration to the solderability. It also allows repeated soldering-unsoldering and the longer soldering times required by reflow techniques.

However nickel barrier amplifies thermal shock and is not recommended for chip sizes equal or greater than CNC Y (30 30) - [C 282 to C 288 - CNC 80 to CNC 94].

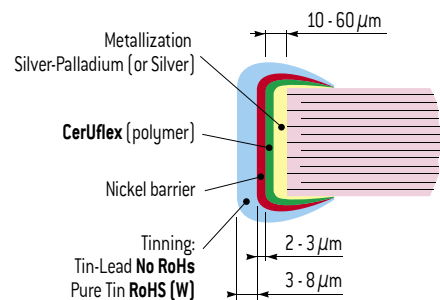















LEADED COMPONENTS

As well as for SMD products, leaded capacitors ranges can also be RoHS. These products, which are characterized by the suffix «W» added to the commercial type, are naturally compatible with the soldering alloys used in RoHS mounting technology. The connections coating is generally an alloy SnAg (with a maximum of 4% Ag). However, on a few products that EXXELIA will precise on request, the coating is pure silver.

Selection Guide

Main Characteristic	Model	Size	Dielectric	Voltage	Capacitance	Temperature	Coating					Leads				Mounting		Main Applications	Page
							Uncoated	Varnished	Conformal coated	Molded	Self-protected	DIL	Ribbon	Axial	Radial	SMD	Through hole		
STANDARD	CEC / CNC SERIES Low and Medium Voltage Chips Capacitors	0402 to 3040	NPO BX 2C1 X7R	10V to 1,000V	1pF to 12µF	-55°C to +125°C	•								•		Precision, stability, decoupling	22	
	NON MAGNETIC CHIPS SERIES Low and Medium Voltage Chips Capacitors	0505 to 2220	NPO X7R	50V to 500V	10pF to 1µF	-55°C to +125°C	•								•		Precision, stability, decoupling	26	
	OP SERIES Open Mode Chips Capacitors	0805 to 2220	NPO X7R	10V to 100V	1pF to 4.7µF	-55°C to +125°C	•								•		Precision, stability, decoupling. Significantly reduce risk of short circuit	28	
	CER / CNR SERIES Low Inductance Chips Capacitors	0306 to 0612	NPO X7R	16V to 100V	1pF to 270nF	-55°C to +125°C	•								•		Decoupling, low ESL, medical embedded	30	
	C3N / C4N / C3E / C4E SERIES Capacitors Arrays	-	NPO X7R	25V to 200V	4.7pF to 33nF	-55°C to +125°C	•								•		Medical embedded, miniaturisation	32	
	30 S4 SERIES Safety Capacitors	-	NPO X7R	40V to 100V	470pF to 820nF	-55°C to +125°C	•					•			•		Railway	33	
	TCE / TCX / TCN / TXR MOLDED SERIES Radial Molded Capacitors	-	NPO BX 2C1 X7R	25V to 500V	1pF to 4.7µF	-55°C to +125°C		•							•	•	Precision, stability, decoupling	34	
	LA SERIES Radial Molded Capacitors	-	NPO Temp. coeff.	25V to 63V	1pF to 680nF	-55°C to +125°C			•						•	•	Decoupling	36	
	TCE / TCX / TCN / TXR AXIAL SERIES Axial Molded Capacitors	-	NPO BX - 2C1 X7R	25V to 500V	1pF to 3.9µF	-55°C to +125°C			•				•		•		Precision, stability, decoupling	38	
	TCE / TCX / TCN / TXR CONFORMAL COATED SERIES Radial Dipped Capacitors	-	NPO BX - 2C1 X7R	25V to 500V	1pF to 6.8µF	-55°C to +125°C			•						•	•	Precision, stability, decoupling	40	
	NON MAGNETIC CONFORMAL COATED SERIES Radial Dipped Capacitors	-	NPO X7R	63V to 500V	180pF to 1µF	-55°C to +125°C			•						•	•	Precision, stability, decoupling	42	
	CK SERIES Radial Molded Capacitors	-	BX	25V to 250V	10pF to 1µF	-55°C to +125°C			•						•	•	Decoupling	44	
HIGH VOLTAGE	C Series High voltage chips Capacitors	1812 to 16080	NPO C4xx X7R	200V to 10kV	10pF to 39µF	-55°C to +125°C	•								•		Power supply, voltage multiplier, radars. • aerospace • space • defence • railways	51	
	TCF Series High voltage Conformal coated leaded Capacitors	-	NPO C4xx X7R	200V to 10kV	10pF to 39µF	-55°C to +125°C			•						•	•		54	
	TKD Series High voltage Conformal coated leaded Capacitors	-	NPO C4xx X7R	200V to 10kV	10pF to 39µF	-55°C to +125°C			•						•	•		57	
	TCL Series High voltage Molded & Varnished leaded Capacitors	-	NPO C4xx X7R	200V to 10kV	10pF to 39µF	-55°C to +125°C			•						•	•		59	
	TCK Series High voltage Molded & Varnished leaded Capacitors	-	NPO C4xx X7R	200V to 5kV	10pF to 39µF	-55°C to +125°C			•						•	•		62	
	CF / CFS Series NEW Pulse capacitors with printed resistor option	1812 to 16080	C4xx	500V to 10kV	27pF to 15µF	-55°C to +125°C	•					•			•			65	
	CS Series High voltage Stacked Capacitors	2220 to 16080	NPO C4xx X7R	1kV to 10kV	220pF to 15µF	-55°C to +125°C	•	•				•	•		•	•		70	

Selection Guide

Main Characteristic	Model	Size range	Dielectric	Voltage range	Capacitance range	Temperature range	Coating					Leads				Mounting		Main Applications	Page
							Uncoated	Varnished	Conformal coated	Molded	Self protected	DIL	Ribbon	Axial	Radial	SMD	Through hole		
HIGH CAPACITANCE	R SERIES (CHIPS) High Capacitance Chips Capacitors 	2225 to 45107	X7R	50V to 500V	47nF to 27µF	-55°C to +125°C	•										•		79
	R SERIES (LEADED) Radial Leaded Conformal Coated Capacitors 	-	X7R	50V to 500V	47nF to 27µF	-55°C to +125°C			•								•		83
	TEF SERIES Radial Leaded Conformal Coated Capacitors 	-	NPO	63V to 500V	10nF to 680nF	-55°C to +125°C			•								•		86
	SV / SC SERIES High Capacitance Stacked Capacitors 	2225 to 125205	X7R	50V to 500V	47nF to 390µF	-55°C to +125°C	•	•			•	•					•	•	87
	CNC3X SERIES High Capacitance Stacked Capacitors 	2220 to 4040	X7R	16V to 25V	1.2µF to 68µF	-55°C to +125°C	•	•			•						•	•	94
	CEC5X SERIES High Capacitance Stacked Capacitors 	3033 to 80150	NPO	63V to 500V	10nF to 6.8µF	-55°C to +125°C	•	•			•						•	•	96
	TEP / TEV SERIES High Capacitance Stacked Capacitors 	-	NPO	63V to 500V	10nF to 6.8µF	-55°C to +125°C			•								•	•	99
TCN8X SERIES High Capacitance Molded Stacked Capacitors 	-	X7R	63V to 500V	0.47µF to 120µF	-55°C to +125°C				•							•	•	101	
HIGH TEMPERATURE	CE / CN SERIES High Temperature Chips Capacitors 	0402 to 3040	NPO X7R	16V to 100V	1pF to 8.2µF	-55°C to +250°C	•										•		106
	SCT SERIES High Temperature Stacked Capacitors 	2225 to 125205	X7R	50V to 500V	47nF to 390µF	-55°C to +215°C	•	•			•						•	•	108
	TCE / TCN MOLDED SERIES HT High Temperature Molded Capacitors 	-	NPO X7R	16V to 100V	1pF to 10µF	-55°C to +220°C				•							•	•	113
	TCE / TCN SELF-PROTECTED SERIES High Temperature Self-Protected Capacitors 	-	NPO X7R	25V to 500V	10pF to 3.9µF	-55°C to +250°C					•						•	•	115
	TCH SERIES High Temperature High Voltage Capacitors 	-	NPO X7R	200V to 10kV	10pF to 15µF	-55°C to +250°C			•								•	•	117
FEED-THRU	TBC SERIES Discoidal Capacitors 	-	NPO X7R	25V to 1kV	10pF to 12µF	-55°C to +125°C	•										•		121
	BPM SERIES Planar Array 	-	X7R	25V to 200V	330pF to 68nF	-55°C to +125°C	•										•		123

Switch Mode Power Supply, filtering, smoothing, decoupling.









- aerospace
- space
- defence

Oil drilling, motor control, braking systems.















Very low ESL

Very low ESL, miniaturisation

Selection Guide

Main Characteristic	Model	Size range	Dielectric	Voltage range	Capacitance range	Temperature range	Coating					Leads			Mounting		Main Applications	Page	
							Uncoated	Varnished	Conformal coated	Molded	Self protected	DIL	Ribbon	Axial	Radial	SMD			Through hole
HIGH Q	XBL SERIES Broadband  NEW	0402	X7R	16V	100nF	-55°C to +125°C	•											DC Blocking, Coupling, Bypassing	144
	UBL SERIES Broadband  NEW	0402	X7R	16V	100nF	-55°C to +125°C	•												146
	UBZ SERIES Broadband  NEW	0201	X5R X6T	10V	100nF	-55°C to +105°C	•												148
	CH SERIES Classic HiQ 	0505 1111	P100	50V to 1.5kV	0.1pF to 1nF	-55°C to +175°C	•				•		•	•				Cellular base station amplifier, MRI.	150
	SH SERIES Super HiQ 	0402 to 1210	NPO	25V to 1.5kV	0.2pF to 1nF	-55°C to +150°C	•				•		•	•				Cellular base station equipment Broadband Point to point/ multi-point radios RF generators	153
	SHD / SHR SERIES Reverse Geometry 	0709 0711	NPO	500V	0.5pF to 100pF	-55°C to +175°C	•							•				156	
	NHB SERIES High Self Resonant Frequency 	1111	NPO	500V	0.3pF to 100pF	-55°C to +175°C	•							•				158	
	CP SERIES High Power 	2225 4040	P100	200V to 7kV	1pF to 10nF	-55°C to +125°C	•	•			•	•	•	•	•			RF power amplifier Plasma chamber MRI coils	160
	CL SERIES High Power 	2225 to 7065	NPO	200V to 7kV	1pF to 10nF	-55°C to +125°C	•	•			•	•	•	•	•			RF power amplifier Plasma chamber MRI coils	164

ADDITIONAL AVAILABLE RANGES (consult our website)

STANDARD	TCE1X Series 	-	NPO	63V to 100V	0.5pF to 10nF	-55°C to +125°C					•							Precision, stability, decoupling	-
	TCN19 Series 	-	2C1	63V to 250V	10pF to 1µF	-55°C to +125°C					•							Decoupling	-
	TCN3X Series 	-	2C1	50V to 100V	100pF to 1,8µF	-55°C to +125°C					•								-
	LA6 Series 	-	2C1	25V to 63V	100pF to 1µF	-55°C to +125°C					•								-
HIGH VOLT.	H Series 	0805 to 6560	NPO X7R	1kV to 10kV	2pF to 390nF	-55°C to +125°C	•	•										Power supply, voltage multiplier, radars.	-
HIGH CAPACITANCE	CNC5X Series 	3033 to 80150	X7R	63V to 500V	0.1µF to 180µF	-55°C to +125°C	•	•			•							Switch Mode Power Supply, filtering, smoothing, decoupling. • aerospace • space • defence	-
	CNC8X Series (chips) 	3033 to 33110	X7R	63V to 400V	47nF to 27µF	-55°C to +125°C	•												-
	CNC8X Series (DIL) 	3333 to 80150	X7R	63V to 400V	47nF to 180µF	-55°C to +125°C	•	•			•								-
	TCP / TCV8X Series 	3333 to 80150	X7R	63V to 400V	47nF to 180µF	-55°C to +125°C		•											-
	TCP / TCV5X Series 	3033 to 80150	X7R	63V to 500V	0.1µF to 180µF	-55°C to +125°C		•											-
	TCF Series 	-	X7R	63V to 500V	0.1µF to 18µF	-55°C to +125°C			•										-
HIGH TEMP.	CNC25X Series 	3033 to 5550	X7R	50V	1µF to 33µF	-55°C to +200°C	•	•			•							Oil drilling, motor control, braking systems.	-
HIGH Q	CNW Series 	-	X7R	100V to 300V	10nF to 1µF	-55°C to +125°C	•							•	•			Power amplifier	-
	SPT519 / CAW CEW Series 	-	NPO	100V to 300V	10nF to 1µF	-55°C to +125°C	•	•						•	•				-

Ceramic Capacitors Technology

MLCC STRUCTURE

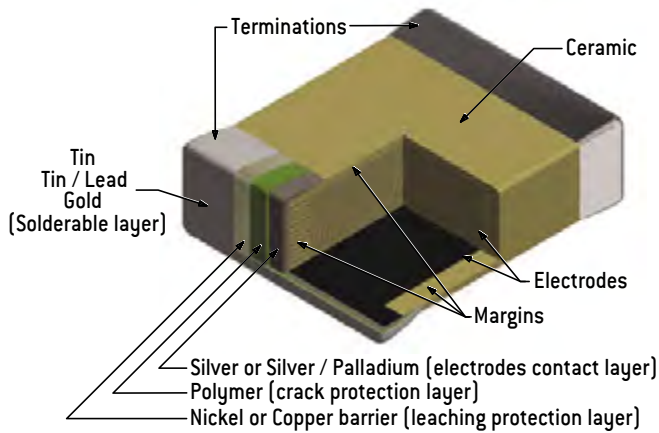

EQUIVALENT CIRCUIT

Capacitor is a complex component combining resistive, inductive and capacitive phenomena. A simplified schematic for the equivalent circuit is:

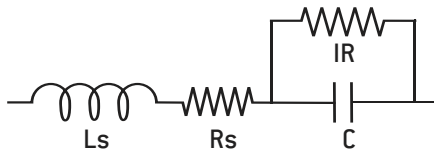

DIELECTRIC CHARACTERISTICS

Insulation Resistance (IR) is the resistance measured under DC voltage across the terminals of the capacitor and consists principally of the parallel resistance shown in the equivalent circuit. As capacitance values and hence the area of dielectric increases, the IR decreases and hence the product $[C \times IR]$ is often specified in $\Omega \cdot F$ or $M\Omega \cdot \mu F$.

The Equivalent Series Resistance (ESR) is the sum of the resistive terms which generate heating when capacitor is used under AC voltage at a given frequency (f) .

Dissipation factor (DF) is the ration of the apparent power input will turn to heat in the capacitor:

$$DF = 2\pi f C ESR$$

When a capacitor works under AC voltage, **heat power loss (P)**, expressed in Watt, is equal to:

$$P = 2\pi f C V_{rms}^2 DF$$

The series inductance (Ls) is due to the currents running through the electrodes. It can distort the operation of the capacitor at high frequency where the **impedance (Z)** is given as:

$$Z = R_s + j [L_s \cdot \omega - 1/(C \cdot \omega)] \text{ with } \omega = 2\pi f$$

When frequency rises, the capacitive component of capacitors is gradually canceled up to the resonance frequency, where :

$$Z = R_s \text{ and } L_s C \cdot \omega^2 = 1$$

Above this frequency the capacitor behaves like an inductor.

	P100	NPO	N2200 (C4xx)	BX	2C1	X7R
Dielectric material	Porcelain	Magnesium titanate or Neodymium baryum titanate	Barium zirconate titanate	Baryum titanate (BaTiO ₃)		
Dielectric constant	15 – 18	20 – 85	450	2,000 – 5,000		
Electrode technology	PME (Precious Metal Electrodes): Ag/Pd					
Capacitance variation between –55°C and +125°C without DC voltage	[100±30]ppm/°C	[0±30]ppm/°C	[–2,200±500] ppm/°C	±15%	±20%	±15%
Capacitance variation between –55°C and +125°C with DC rated voltage			0-15%	15%–25%	20%–30%	Not applicable
Piezo-electric effect	None		None	Yes		
Dielectric absorption	None		Few %	Few %		
Thermal shock sensitive	+		+	++		

Ceramic Capacitors Technology

MANUFACTURING STEPS

SLIP CASTING



A slurry, a mix of ceramic powder, binder and solvents, is poured onto conveyor belt inside a drying oven, resulting in a dry ceramic sheet.

ELECTRODE SCREEN PRINTING

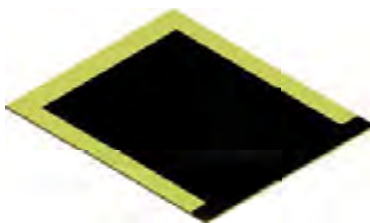

The electrode ink, made from a metal powder mixed with solvents, is printed onto the ceramic sheets using a screen printing process.

STACKING

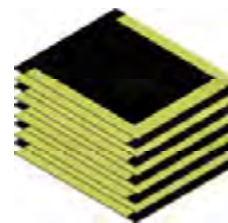

The sheets with electrode printed are stacked to create a multilayer structure.

TERMINATIONS

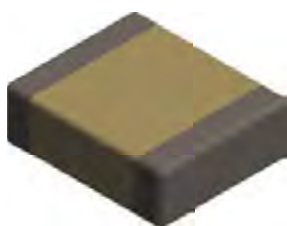

Each terminal of the capacitor is dipped in the termination ink, mix of metal powder, solvents and glass frit and the parts are fired in an oven.

SINTERING

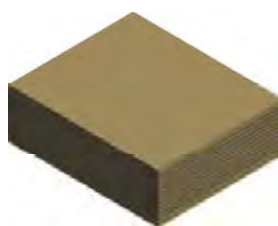

The parts are sintered in an oven with a precise temperature profile which is very important to the characteristics of the capacitors.

PRESSING

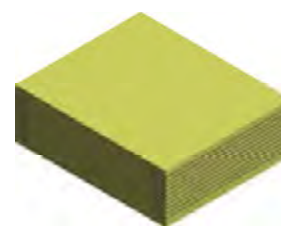

Pressure is applied to the stack to fuse all the separate layers, this created a monolithic structure.

TERMINATIONS PLATING

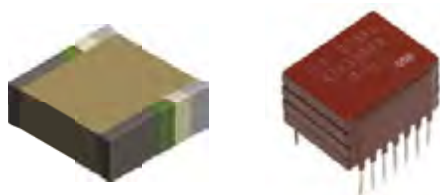

Stacking + leads soldering + encapsulation
[see pages 10-11]

FINAL TESTING

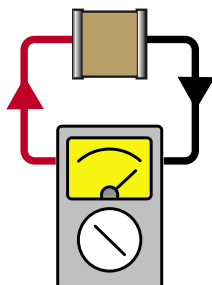

PACKAGING



User Guide

SMD TERMINATIONS

NON RoHS COMPLIANT	Code	RoHS COMPLIANT	Code	Recommended mounting process							Storage (months)*
				Magnetic	Epoxy bonding	Iron soldering	Wave soldering	Vapor phase soldering	Infrared soldering	Wire bonding	
Ag	Q	Ag	QW / P	No	•	•	•	•			18
Ag/Pd/Pt	-	Ag/Pd/Pt	W / A	No	•	•	•				24
Ag/Pd/Pt + dipped Sn/Pb 60/40	H	Ag/Pd/Pt + dipped Sn	HW	No		•					24
Ag + Ni + electrolytic Sn/Pb 95/5	C	Ag + Ni + electrolytic Sn	CW / S	Yes		•	•	•	•		18
Ag + Ni + electrolytic Sn/Pb 60/40	D	-	-	Yes		•	•	•	•		18
-	-	Ag + Cu + electrolytic Sn	C**	No		•	•	•	•		18
Ag + Ni + dipped Sn/Pb 60/40	E	-	-	Yes		•	•				24
Ag + Ni + Au	G	Ag + Ni + Au	GW	Yes	•	•	•	•	•	•	36
Ag + Polymer + Ni + Sn/Pb 95/5	YC	Ag + Polymer + Ni + Sn	YCW	Yes		•	•	•	•		18
Ag + Polymer + Ni + Sn/Pb 60/40	YD	-	-	Yes		•	•	•	•		18
Ag + Polymer + Ni + Au	YG	Ag + Polymer + Ni + Au	YGW	Yes	•	•	•	•	•	•	36

Nickel (Ni) or Copper (Cu) barriers amplify thermal shock and are not recommended for chip sizes larger than 3030.

* Storage must be in a dry environment at a temperature of 20°C with a relative humidity below 50%, or preferably in a package enclosing a desiccant.

** Non magnetic chips series only.

SMD ENVIRONMENTAL TESTS

Ceramic chip capacitors for SMD are designed to meet test requirements of **CECC 32100** and **NF C 93133** standards as specified below in compliance with **NF C 20700** and **IEC 68** standards:

- Solderability: **NF C 20758**, 260°C, bath 62/36/2.
- Adherence: 5N force.
- Vibration fatigue test: **NF C 20706**, 20 g, 10 Hz to 2,000 Hz, 12 cycles of 20 minutes each.
- Rapid temperature change: **NF C 20714**, -55°C to + 125°C, 5 cycles.
- Combined climatic test: **IEC 68-2-38**.
- Damp heat: **NF C 20703**, 93 %, H.R., 40°C.
- Endurance test: 1,000 hours, 1.5 U_{RC}, 125°C.

STORAGE OF CHIP CAPACITORS

TINNED OR NON TINNED CHIP CAPACITORS

Storage must be in a dry environment at a temperature of 20°C with a relative humidity below 50 %, or preferably in a packaging enclosing a desiccant.

STORAGE IN INDUSTRIAL ENVIRONMENT:

- 2 years for tin dipped chip capacitors,
- 18 months for tin electroplated chip capacitors,
- 2 years for non tinned chip capacitors,
- 3 years for gold plated chip capacitors.

STORAGE IN CONTROLLED NEUTRAL NITROGEN ENVIRONMENT:

- 4 years for tin dipped or electroplated chip capacitors,
- 4 years for non tinned chip capacitors,
- 5 years for gold plated chip capacitors.

Storage duration should be considered from delivery date and not from batch manufacture date. The tests carried out at final acceptance stage [solderability, susceptibility to solder heat] enable to assess the compatibility to surface mounting of the chips.

User Guide

LEAD STYLES

SURFACE MOUNTING

DIL LEADS

P style



PL style

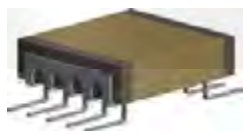

L style



J style



RIBBON LEADS

Micro-strip (type 1)
Short Micro-strip (type 1S)

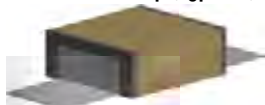

Axial (Type 2)

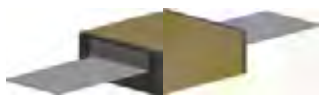

Radial (Type 3)



R style



RX style



RJ style



Please contact Exxelia sales for any lead configuration not shown.

TROUGH-HOLE MOUNTING

AXIAL AND RADIAL

Radial leads (Type 6)



Radial leads (4 leads)



Axial leads (Type 7)



DIL leads: N style

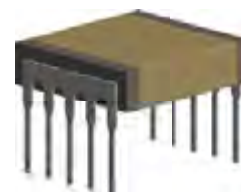

ENCAPSULATION STYLES

Ceramic encapsulation
(selfprotected)



Varnish



Conformal coating



Molding



User Guide

SOLDERING ADVICES FOR REFLOW SOLDERING

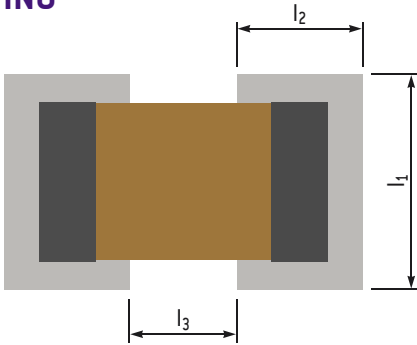

Large chips above size 2225 are not recommended to be mounted on epoxy board due to thermal expansion coefficient mismatch between ceramic capacitor and epoxy. Where larger sizes are required, it is recommended to use components with ribbon or other adapted leads so as to absorb thermo-mechanical strains.

Dimensions in inches (in mm)	Reflow soldering						Wave soldering					
	l ₁		l ₂		l ₃		l ₁		l ₂		l ₃	
0402	0.043	(1.1)	0.035	(0.9)	0.012	(0.3)	0.043	(1.1)	0.047	(1.2)	0.012	(0.3)
0403	0.055	(1.4)	0.035	(0.9)	0.012	(0.3)	0.055	(1.4)	0.047	(1.2)	0.012	(0.3)
0504	0.063	(1.6)	0.051	(1.3)	0.016	(0.4)	0.063	(1.6)	0.063	(1.6)	0.016	(0.4)
0603	0.055	(1.4)	0.059	(1.5)	0.02	(0.5)	0.055	(1.4)	0.071	(1.8)	0.02	(0.5)
0805	0.073	(1.85)	0.065	(1.65)	0.024	(0.6)	0.073	(1.85)	0.077	(1.95)	0.024	(0.6)
0907	0.094	(2.4)	0.065	(1.65)	0.035	(0.9)	0.094	(2.4)	0.077	(1.95)	0.035	(0.9)
1005	0.073	(1.85)	0.067	(1.7)	0.039	(1)	0.073	(1.85)	0.079	(2)	0.039	(1)
1206	0.083	(2.1)	0.067	(1.7)	0.059	(1.5)	0.083	(2.1)	0.079	(2)	0.059	(1.5)
1210	0.118	(3)	0.069	(1.75)	0.059	(1.5)	0.118	(3)	0.081	(2.05)	0.059	(1.5)
1605	0.073	(1.85)	0.071	(1.8)	0.087	(2.2)	0.073	(1.85)	0.083	(2.1)	0.087	(2.2)
1806	0.087	(2.2)	0.073	(1.85)	0.102	(2.6)	0.087	(2.2)	0.085	(2.15)	0.102	(2.6)
1812	0.152	(3.85)	0.073	(1.85)	0.102	(2.6)	0.152	(3.85)	0.085	(2.15)	0.102	(2.6)
1825	0.281	(7.15)	0.073	(1.85)	0.102	(2.6)	0.281	(7.15)	0.085	(2.15)	0.102	(2.6)
2210	0.13	(3.3)	0.079	(2)	0.146	(3.7)	0.13	(3.3)	0.091	(2.3)	0.146	(3.7)
2220	0.228	(5.8)	0.079	(2)	0.146	(3.7)	0.228	(5.8)	0.091	(2.3)	0.146	(3.7)
2225	0.281	(7.15)	0.079	(2)	0.146	(3.7)	0.281	(7.15)	0.091	(2.3)	0.146	(3.7)

RECOMMENDED FOOTPRINT FOR SMD CAPACITORS

Ceramic is by nature a material which is sensitive both thermally and mechanically. Stresses caused by the physical and thermal properties of the capacitors, substrates and solders are attenuated by the leads.

Wave soldering is unsuitable for sizes larger than 2220 and for the higher ends of capacitance ranges due to possible thermal shock (capacitance values given upon request).

Infrared and vapor phase reflow, are preferred for high reliability applications as inherent thermo-mechanical strains are lower than those inherent to wave soldering.

Whatever the soldering process is, it is highly recommended to apply a thermal cycle, see hereafter our recommended soldering profile:

RECOMMENDED VAPOR PHASE REFLOW PROFILE

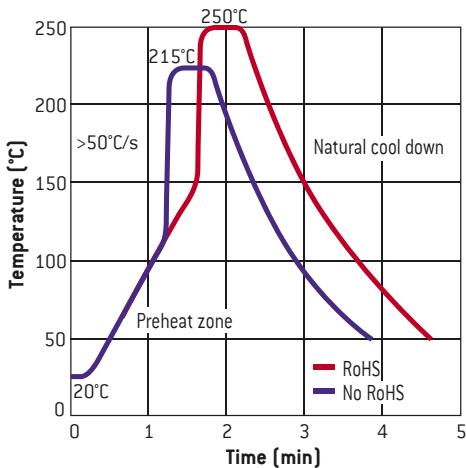

RECOMMENDED IR REFLOW PROFILE

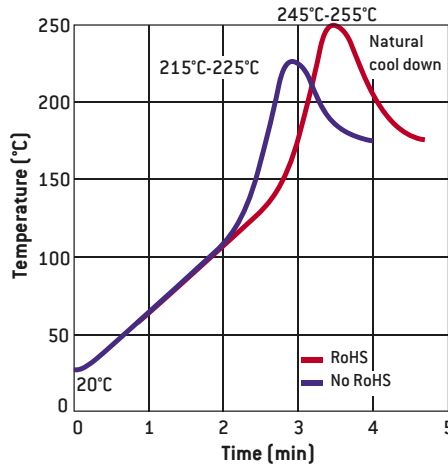

RECOMMENDED WAVE SOLDERING PROFILE

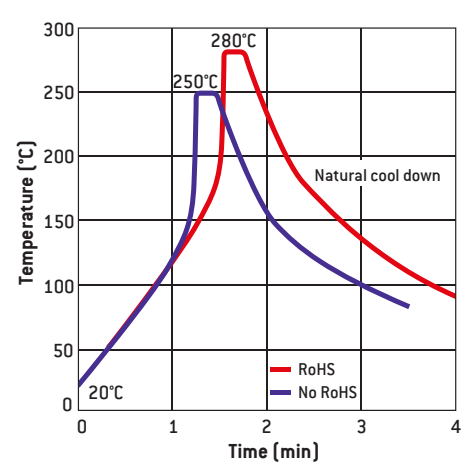

SOLDERING ADVICES FOR IRON SOLDERING

Attachment with a soldering iron is discouraged due to ceramic brittleness and the process control limitations. In the event that a soldering iron must be used, the following precautions should be observed:

- Use a substrate with chip footprints big enough to allow putting side by side one end of the capacitor and the iron tip without any contact between this tip and the component,
- place the capacitor on this footprint,

- heat the substrate until the capacitor's temperature reaches 150°C minimum (preheating step, maximum 1°C per second),
- place the hot iron tip (a flat tip is preferred) on the footprint **without touching the capacitor**. Use a regulated iron with a 30 watts maximum power. The recommended temperature of the iron is 270 ±10°C. The temperature gap between the capacitor and the iron tip must not exceed 120°C,

User Guide

- leave the tip on the footprint for a few seconds in order to increase locally the footprint's temperature,
- use a cored wire solder and put it down on the iron tip. In a preferred way use Sn/Pb/Ag 62/36/2 alloy,
- wait until the solder fillet is formed on the capacitor's termination,
- take away iron and wire solder,
- wait a few minutes so that the substrate and capacitor come back down to

the preheating temperature,

- solder the second termination using the same procedure as the first,
- let the soldered component cool down slowly to avoid any thermal shock.

PACKAGING

TAPE AND REEL

The films used on the reels correspond to standard IEC 60286-3. Films are delivered on reels in compliance with document IEC 286-3 dated 1991.

Minimum quantity is 250 chips.

Maximum quantities per reel are as follows:

- Super 8 reel - Ø 180: 2,500 chips.
- Super 8 reel - Ø 330: 10,000 chips.
- Super 12 reel - Ø 180: 1,000 chips.

Reel marking complies with CECC 32100 standard:

- Model.
- Rated capacitance.
- Capacitance tolerance.
- Rated voltage.
- Batch number.

TRAY PACKAGES

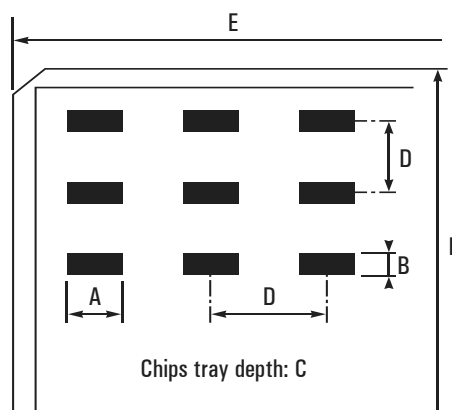

DIMENSIONAL CHARACTERISTICS OF CHIPS TRAY PACKAGES

Sizes	Nr. of chips/ package	Oriented chips	Dimensions in inches (in mm)				
			A	B	C	D	E
0402	100	No	0.0112 (0.302)		0.065 (1.65)	0.167 (4.24)	2 (50.8)
0403	100	No	0.0112 (0.302)		0.065 (1.65)	0.167 (4.24)	2 (50.8)
0504	100	Yes	0.059 (1.5)	0.045 (1.14)	0.035 (0.89)	0.167 (4.24)	2 (50.8)
0603	340	Yes	0.1 (2.54)	0.06 (1.52)	0.045 (1.14)	0.167 (4.24)	2 (50.8)
0805	100	Yes	0.1 (2.54)	0.06 (1.52)	0.045 (1.14)	0.167 (4.24)	2 (50.8)
1206	100	No	0.14 (3.56)	0.14 (3.56)	0.06 (1.52)	0.167 (4.24)	2 (50.8)
1210	100	Yes	0.14 (3.56)	0.14 (3.56)	0.06 (1.52)	0.167 (4.24)	2 (50.8)
1812	100	No	0.25 (6.35)	0.25 (6.35)	0.13 (3.3)	0.345 (8.76)	4 (101.6)
	25	Yes	0.24 (6.1)	0.265 (6.73)	0.07 (1.78)	0.345 (8.76)	2 (50.8)
2220	100	Yes	0.25 (6.35)	0.25 (6.35)	0.13 (3.3)	0.345 (8.76)	4 (101.6)
	25	Yes	0.24 (6.1)	0.265 (6.73)	0.07 (1.78)	0.345 (8.76)	2 (50.8)

HIGH Q CAPACITORS TAPE AND REEL PACKAGING SPECIFICATIONS

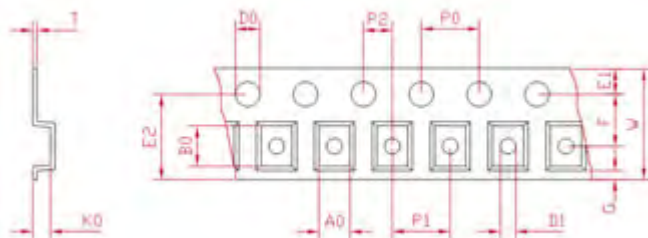

Sizes	Type (1)	W±0.3 inches (mm)	F±0.05 inches (mm)	P1±0.1 inches (mm)	T max. inches (mm)	Reel Size inches (mm)	Quantity per Reel
A (0505)	H	0,315 (8)	0,138 (3.5)	0,157 (4)	0,010 (0,25)	7,087 (180)	3'000
A (0505)	V	0,315 (8)	0,138 (3.5)	0,157 (4)	0,010 (0,25)	7,087 (180)	3'000
S (0603)	H	0,315 (8)	0,138 (3.5)	0,157 (4)	0,016 (0,4)	7,087 (180)	4'000
F (0805)	H	0,315 (8)	0,138 (3.5)	0,157 (4)	0,016 (0,4)	7,087 (180)	4'000
B (1111)	H	0,315 (8)	0,138 (3.5)	0,157 (4)	0,012 (0,3)	7,087 (180)	1'000
B (1111)	V	0,315 (8)	0,138 (3.5)	0,157 (4)	0,010 (0,25)	7,087 (180)	1'000
X (2225)	H	0,472 (12)	0,138 (5.5)	0,472 (12)	0,018 (0,45)	12,992 (330)	500
E (4040)	H	0,945 (24)	0,453±0,004 (11.5±0.1)	0,630 (16)	0,018 (0,45)	12,992 (330)	700
E (4040)	V	1,260 (32)	0,559±0,004 (14.2±0.1)	0,945 (24)	0,022 (0,55)	15 (381)	350

(1): Horizontal (H) or Vertical (V) orientation in cavities.

User Guide

EIA STANDARD CAPACITANCE VALUES

Following EIA standard, the values and multiples that are indicated in the chart below can be ordered. E48, E96 series and intermediary values are available upon request.

E6 (± 20%)	E12 (± 10%)	E24 (± 5%)
10	10	10
	12	11
		12
15	15	13
		15
	18	16
		18
		20
22	22	22
	27	24
		27
33	33	30
		33
	39	36
		39
		43
47	47	47
	56	51
		56
		62
68	68	68
	82	75
		82
		91

Voltage (V)	Code	Letter code
25	250	A
40	400	B
50	500	C
63	630	D
100	101	E
200	201	G
250	251	H
400	401	K
500	501	L
1,000	102	M
2,000	202	P
3,000	302	R
4,000	402	S
5,000	502	T
7,500	752	U
10,000	103	W

EIA CAPACITANCE CODE

The capacitance is expressed in three digit codes and in units of pico Farads (pF). The first and second digits are significant figures of the capacitance value and the third digit identifies the multiplier.

For capacitance value < 10pF, R designates a decimal point.
See examples below:

EIA code	Capacitance value		
	in pF	in nF	in μ F
2R2	2.2	0.0022	0.0000022
6R8	6.8	0.0068	0.0000068
220	22	0.022	0.000022
470	47	0.047	0.000047
181	180	0.18	0.00018
221	220	0.22	0.00022
102	1,000	1	0.001
272	2,700	2.7	0.0027
123	12,000	12	0.012
683	68,000	68	0.068
124	120,000	120	0.12
564	560,000	560	0.56
335	3,300,000	3,300	3.3
825	8,200,000	8,200	8.2
156	15,000,000	15,000	15
686	68,000,000	68,000	68
107	100,000,000	100,000	100
227	220,000,000	220,000	220

PART MARKING TOLERANCE CODES

Use the following tolerance code chart for part markings:

Tolerance	Letter code
±0.25pF	CU
±0.5pF	DU
±1pF	FU
±1%	F
±2%	G
±5%	J
±10%	K
±20%	M

PART MARKING VOLTAGE CODES

Use the following voltage code chart for part markings:

User Guide

RELIABILITY LEVELS

Exxelia proposes different reliability levels for the ceramic capacitors for both NPO and X7R ceramics.

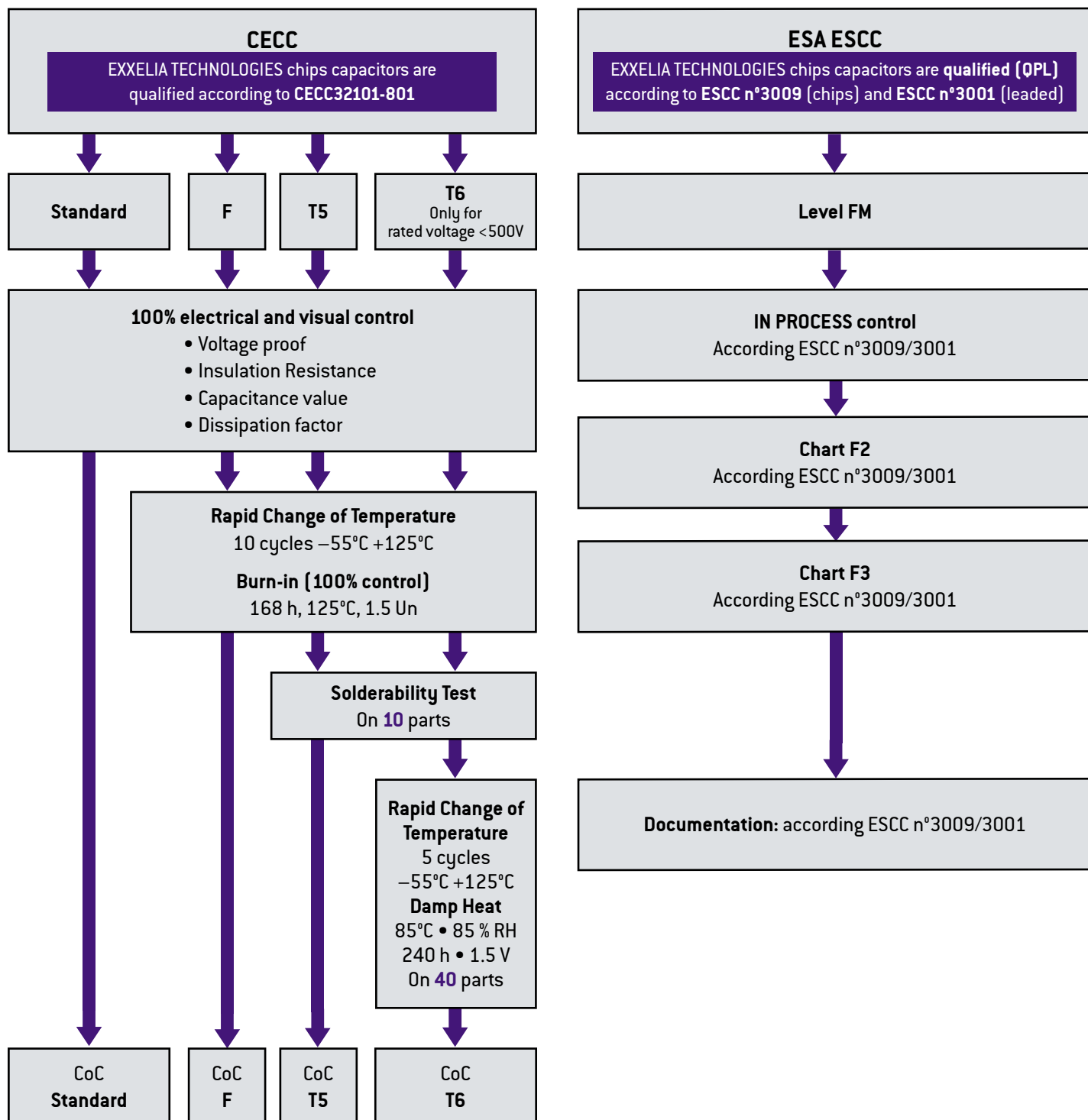

As the world's leading manufacturer of specific passive components, we stand apart through our ability to quickly evaluate the application specific engineering challenges and provide a cost-effective and efficient solutions.

For requirements that cannot be met by catalog products, we offer leading edge solutions in custom configuration: custom geometries, packaging, characteristics, all is possible thanks to our extensive experience and robust development process, while maintaining the highest level of reliability.

Where necessary, special testing is done to verify requirements, such as low dielectric absorption, ultra-high insulation resistance, low dissipation factor, stability under temperature cycling or under specified environmental conditions, etc.

HIGH CAPACITANCE

- High energy density
- Specific case sizes
- Specific shape of connections (high resistance to vibrations)

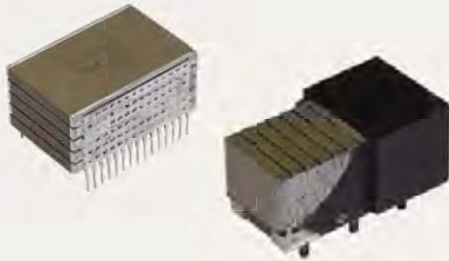

HIGH VOLTAGE

- Up to 50 kV
- Specific circular shape

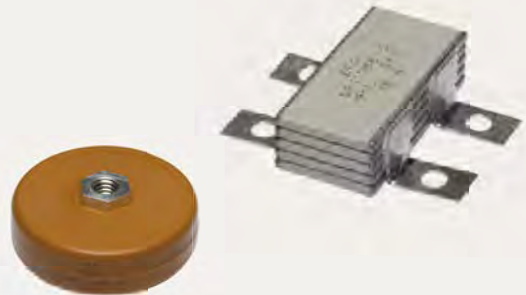

HIGH TEMPERATURE

- Up to 250°C
- Specific shape of connections
- 2,000 hours life time
- HMP soldering



OTHERS

- Screen printed resistors
- Complex components
- Full functions available

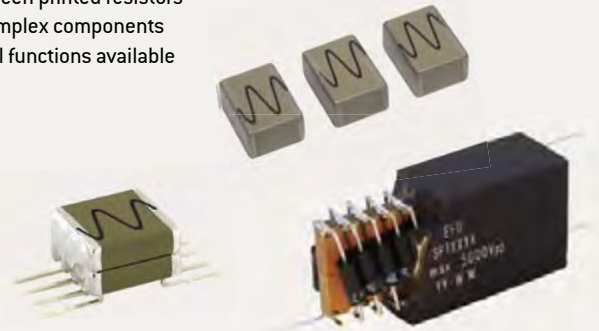

STANDARD

GENERAL INFORMATION NPO/COG..... 18

GENERAL INFORMATION X7R..... 20

CEC / CNC SERIES

Low and Medium Voltage Chips Capacitors 22

NON MAGNETIC CHIPS SERIES

Low and Medium Voltage Chips Capacitors 26

OP SERIES

Open Mode Chips Capacitors 28

CER / CNR SERIES

Low inductance Chips Capacitors 30

C3N / C4N / C3E / C4E SERIES

Capacitors Arrays 32

30 S4 SERIES

Safety Capacitors 33

TCE / TCX / TCN / TXR MOLDED SERIES

Radial Molded Capacitors..... 34

LA SERIES

Radial Molded Capacitors..... 36

TCE / TCX / TCN / TXR AXIAL SERIES

Axial Molded Capacitors 38

TCE / TCX / TCN / TXR CONFORMAL COATED SERIES

Radial Dipped Capacitors 40

NON MAGNETIC CONFORMAL COATED SERIES

Radial Dipped Capacitors 42

CK SERIES

Radial Molded Capacitors..... 44



General Information NPO/COG (Class 1)

COMPOSITION

NPO capacitors are produced by using a dielectric made of titanium dioxide (TiO_2) modified by magnesium oxide MgO (white ceramics) or a rare earth oxide, e.g. Nd_2O_3 (other NPO ceramics).

As a consequence, these ceramics are non ferro-electric materials with a low dielectric constant ($\epsilon_r \leq 110$).

Other additives are used to dope the dielectric constant up to 300. Though derogating from CG class, doped dielectric constant features a linear temperature drift and a matchless stability compared with class 2 ceramics.

The wide range of possible NPO dielectric compositions enables to use the material best suited to the application :

- standard applications,
- high voltage,
- high temperature,
- microwave,
- power capacitors.

«Temperature coefficient» compositions are particularly suitable for impedance matching. These ceramics usually enable to achieve temperature coefficients from 0 to $-1\,000\text{ ppm}/^\circ\text{C}$. For specific requirements, other coefficients can be achieved (e.g. $-3\,300\text{ ppm}/^\circ\text{C}$).

STABILITY

As ϵ_r is low, these dielectrics are extremely stable with only minor changes under such stresses as :

- temperature,
- voltage,
- frequency.

In addition, they are not affected by piezo-electric phenomena and their dielectric absorption coefficients are low and even non measurable for dielectrics with the lowest constants.

MECHANICAL PROPERTIES

Class 1 ceramics are the perfect match for metallic electrodes made of Pd or Ag-Pd alloy and have a high hardness and mechanical toughness making them resistant to thermal shocks (wave soldering for instance) and to thermal cycling after mounting on substrates having an expansion coefficient close to the capacitor one.

Ceramic chips meet CECC 32100 and NF C 93133 standards.

CLIMATIC CATEGORIES

Climatic categories are identified by three-digit codes as per NF C 20700 standard. Coding method is described in table 6.

e.g. : $-55^\circ\text{C} + 125^\circ\text{C} / 56$ days category is identified by code 434.

TEMPERATURE COEFFICIENT

Temperature coefficient $k\theta$ (ppm/ $^\circ\text{C}$)		
$k\theta$	Tolerances	Code letter
+ 100	± 30	AG
0	± 30	CG
- 33	± 30	HG
- 75	± 30	LG
- 150	± 30	PG
- 220	± 30	RG
- 330	± 60	SH
- 470	± 60	TH
- 750	± 120	UJ
- 1 000	± 250	QK

General Information NPO/COG (Class 1)

IMPEDANCE VERSUS FREQUENCY

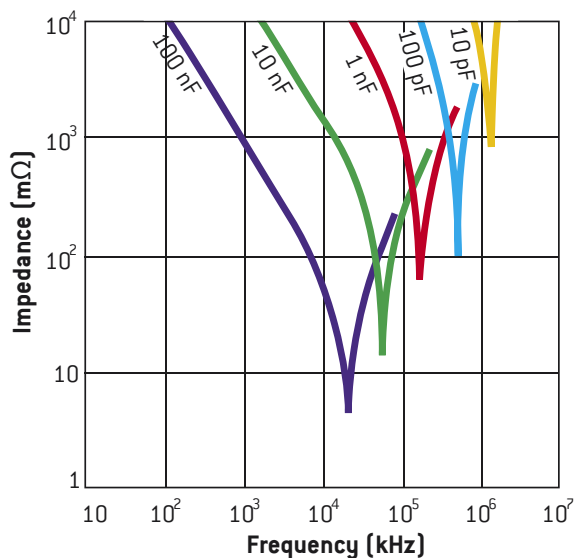

DISSIPATION FACTOR VERSUS FREQUENCY

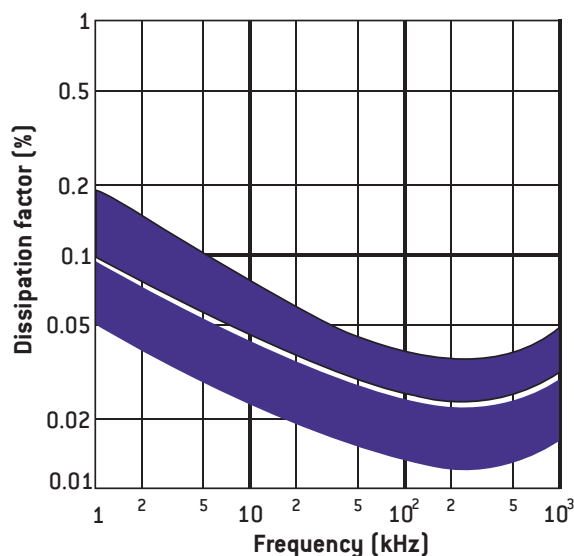

CAPACITANCE CHANGE VERSUS TEMPERATURE

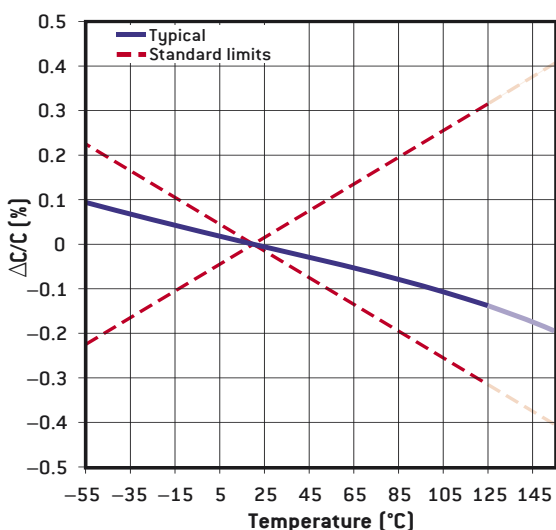

IR VERSUS TEMPERATURE

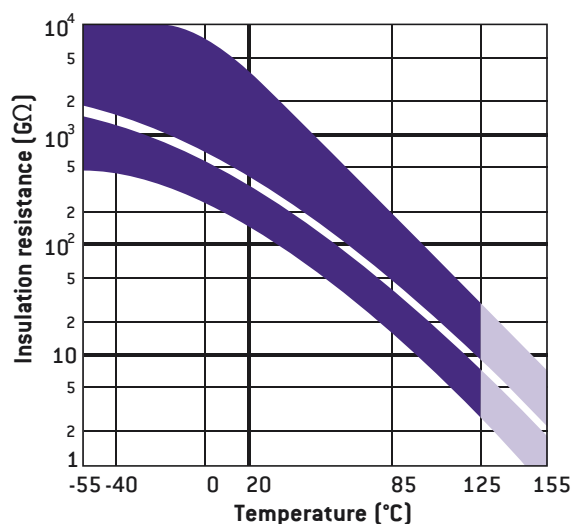

DISSIPATION FACTOR VERSUS TEMPERATURE

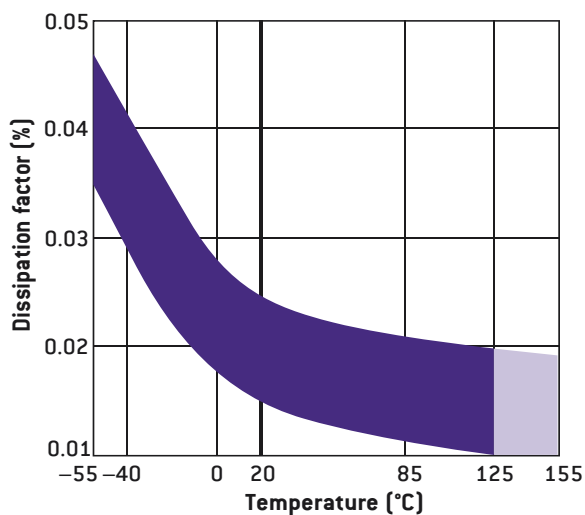

TYPICAL FAILURE RATE VERSUS TEMPERATURE

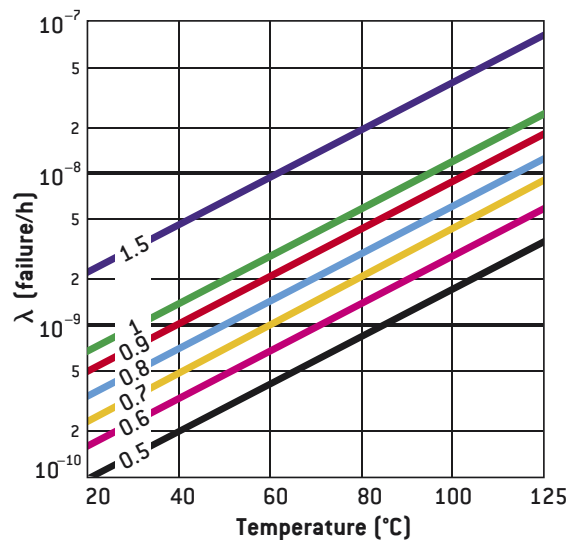

STANDARD

General Information X7R (Class 2)

COMPOSITION

Class 2 capacitors are produced by using a dielectric made of barium titanate (Ba Ti O_3). By nature, the dielectric is a ferroelectric compound with a high dielectric constant usually varying :

- from 1 000 to 5 000 - typical of capacitors meeting 2C1 type specifications (BX, X7R),
- from 5 000 to 15 000 - typical of capacitors meeting Z5U or Y5V type specifications.

Depending on whether the dielectric contains a flux additive, mainly bismuth or boron, electrodes are made of Ag-Pd alloys with high silver content or high palladium content, even pure palladium in some cases.

STABILITY

As the dielectric is a ferro-electric material, class 2 capacitors present significant variations under such stresses as :

- temperature,
- voltage,
- frequency.

In addition, the dielectric absorption coefficient can reach a few % and piezo-electric phenomena can affect the dielectric at critical frequencies (full information and specific documents available on request).

MECHANICAL PROPERTIES

Class 2 dielectrics are hard materials and are sensitive to thermo-mechanical stress. Stress should be limited when mounting and adequate substrates with an adapted expansion coefficient used.

BISMUTH OR BISMUTH FREE DIELECTRICS

Class 2 capacitors are made of ceramics capable to embed a flux element (e.g. bismuth or boron salt). Their eventual use will affect the choice of electrode alloys firing temperature used. Capacitor behavior under such constraints as temperature, voltage, frequency and even reliability, in some applications (further information available on request), is also different.

That is why French and European standard authorities have decided to differentiate bismuth from bismuth free ceramics by measuring tangent δ at -55°C . Tangent $\text{Tg } \delta (-55^\circ\text{C})$ 350.10^{-4} in flux free dielectrics.

Flux free dielectrics are identified by suffix «A» after capacitor type (e.g. CNC2A).

CAPACITANCE/TEMPERATURE RELATIONSHIP

Capacitance variations are defined within a specified temperature range, $+20^\circ\text{C}$ being the reference temperature. This characteristic is expressed by associating the temperature range and capacitance stability.

Stability category Code letter	Max. capacitance variation (%) with reference to capacitance at 20°C	
	Without voltage	At rated DC voltage (U_{DC})
B	± 10	+ 10 – 15
C	± 20	+ 20 – 30
D	+ 20 – 30	+ 20 – 40
E	+ 20 – 55	+ 20 – 65
R	+ 15 – 15	Not applicable
X	+ 15 – 15	+ 15 – 25

Temperature category	
Code	Temperature range
1	$-55^\circ\text{C} + 125^\circ\text{C}$
2	$-55^\circ\text{C} + 85^\circ\text{C}$
4	$-25^\circ\text{C} + 85^\circ\text{C}$

CAPACITANCE CHANGE VERSUS FREQUENCY

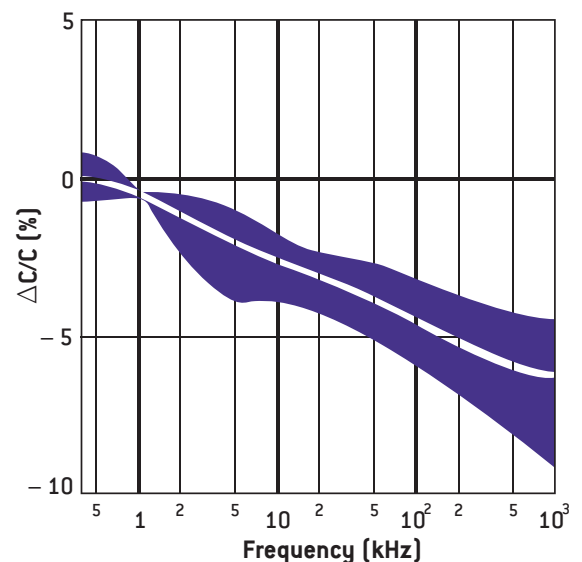

General Information X7R (Class 2)

STANDARD

IMPEDANCE VERSUS FREQUENCY

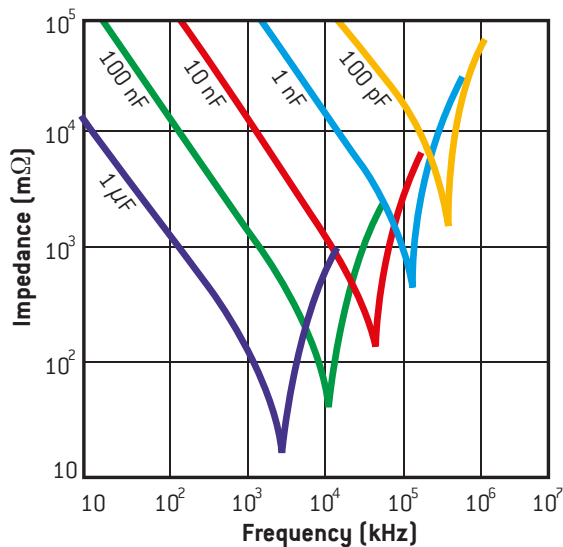

DISSIPATION FACTOR VERSUS FREQUENCY

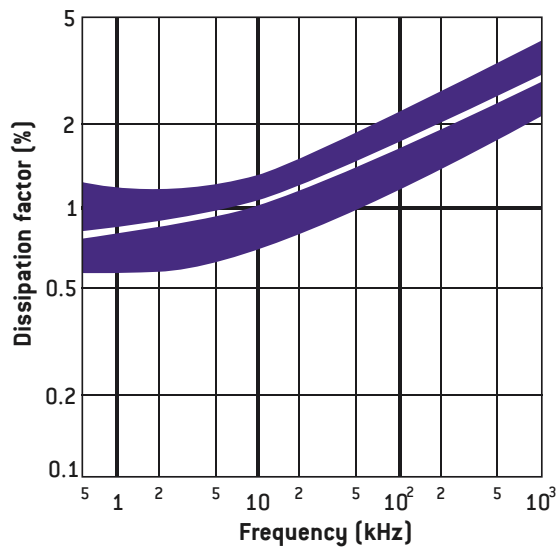

DISSIPATION FACTOR VERSUS TEMPERATURE

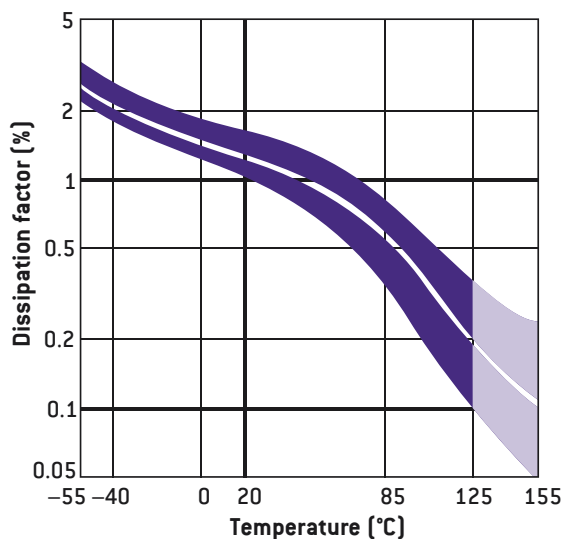

CAPACITANCE CHANGE VERSUS TEMPERATURE

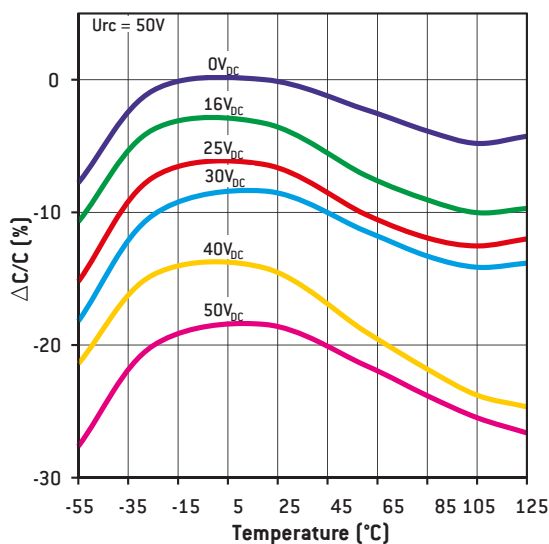

IR VERSUS TEMPERATURE

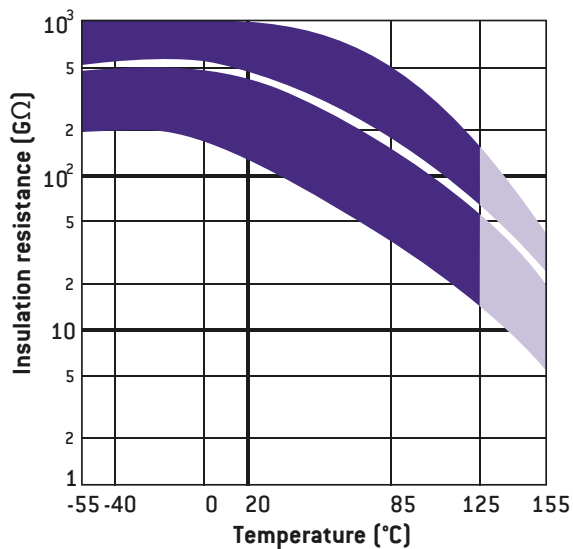

TYPICAL FAILURE RATE VERSUS TEMPERATURE

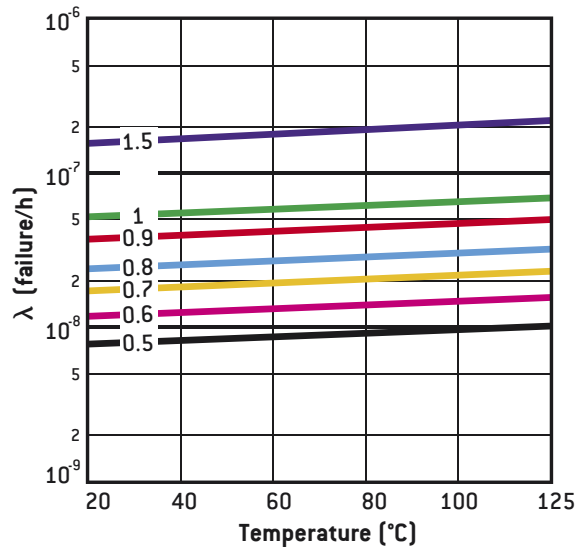

CEC / CNC Series

Low and Medium Voltage Chips Capacitors

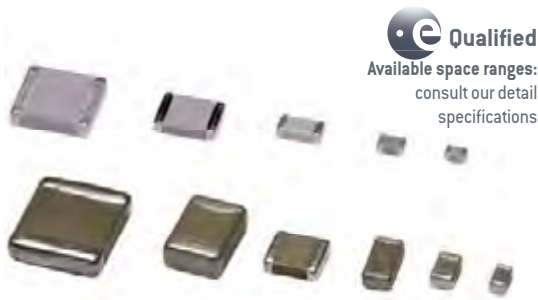

Qualified
Available space ranges:
consult our detail
specifications

In accordance with the specifications of CECC 32101 and NF C 93133 standards

FEATURES

- Case sizes: 0402 - 3040
- NPO, BX, 2C1, X7R dielectrics
- Capacitance range: 1pF to 12µF
- Ag/Pd/Pt, Ni barrier, epoxy terminations available
- RoHS and Non RoHS compliant capacitors available
- Screening in accordance with ESA specifications available

PHYSICAL CHARACTERISTICS

CONSTRUCTION

MLCC capacitors for surface mounting with optional Nickel barrier

MARKING (on request)

Capacitance value coded (from 0805 to 3040 sizes).

PACKAGING (see page 13)

S8* = available for 0402 to 1210 sizes.

S12* = available for 1812 to 2220 sizes.

BA* = available for 0402 to 2220 (except 0907) sizes.

* not available with H, HW and E, terminations

HOW TO ORDER

CNC4	-	C	M	F	56nF	10%	50V	S8	T5
Series	Bismuth	Termination	Marking	Quality level	Capacitance	Tolerance	Rated voltage	Packaging	Reliability level
CEC •• NPO Ceramic CNC •• BX, 2C1, 2R1/X7R Ceramics See Ratings and Case code table	Option A [= bismuth free dielectric] available on request. Please consult us.	W = RoHS compliant - Ag/Pd/Pt W Ag/Pd/Pt Q Ag* QW Ag H Ag/Pd/Pt + dipped Sn/Pb 60/40 HW Ag/Pd/Pt + dipped Sn C Ag + Ni** + electrolytic Sn/Pb 95/5 CW Ag + Ni + electrolytic Sn D Ag + Ni*** + electrolytic Sn/Pb 60/40 - E Ag + Ni**** + dipped Sn/Pb 60/40 G Ag + Ni + Au GW Ag + Ni + Au YC Ag + Polymer + Ni + Sn/Pb 95/5 YCW Ag + Polymer + Ni + Sn YD Ag + Polymer + Ni + Sn/Pb 60/40 - YG Ag + Polymer + Ni + Au YGW Ag + Polymer + Ni + Au		- = no marking M = Marking: capacitance value coded (from 0805 to 3040 sizes).	- = standard quality level F = Hi-Rel quality: screening in accordance with Exxelia specification	Capacitance value in clear NPO: cap. value ≤ 12pF ±0.25pF cap. value ≤ 8.2pF ±0.5pF ±1pF cap. value > 22pF ±1% cap. value > 12pF ±2% cap. value > 8.2pF ±5% ±10% cap. value > 3.9pF ±20% BX, 2C1 and X7R: ±5% ±10% ±20%	10V 16V 25V 50V 100V 200V 500V 1000V Intermediary and higher voltages available on request.	- = Exxelia packaging S8* = available for 0402 to 1210 sizes. S12* = available for 1812 to 2220 sizes. BA* = available for 0402 to 2220 (except 0907) sizes. * not available with H, HW and E, terminations see page 13	For F parts only. Acc. to Exxelia spec. - T5 T6 See page 15
		* Only 1812 to 3040 sizes							
		** Only 0402 to 2220 sizes (other sizes on demand)							
		*** Only 0402 to 1806 sizes (other sizes on demand)							
		**** Only 2225 to 3040 sizes							

ELECTRICAL SPECIFICATIONS

Description	NPO
Operating temperature	-55°C to +125°C
Climatic category	55 / 125 / 56
Rated voltage (U _{RC})	10V _{DC} to 1,000V _{DC}
Maximum ΔC/°C over temperature range without DC voltage applied	NA
Maximum ΔC/°C over temperature range with rated voltage applied	NA
Temperature coefficient with or without DC voltage applied	[0±30]ppm/°C
Dielectric withstanding voltage	2.5 U _{RC} for U _{RC} ≤ 500V _{DC}
	1.6 U _{RC} for U _{RC} = 1,000V _{DC}
	1.5 U _{RC} for U _{RC} = 1,000V _{DC}
Capacitance	at 1MHz for C ≤ 1,000pF
	at 1kHz for C > 1,000pF
Dissipation factor at 25°C	≤ 0.015 (150/C + 7)% at 1MHz for C ≤ 50pF
	≤ 0.15% at 1MHz for 50pF < C ≤ 1,000pF
	≤ 0.15% at 1kHz for C > 1,000pF
Insulation resistance at 25°C	≥ 100,000 MΩ for C ≤ 10nF
	under U _{RC} for U _{RC} ≤ 500V _{DC}
	≥ 1,000 MΩ.µF for C > 10nF under 500V _{DC} for U _{RC} > 500V _{DC}
Aging	None

Description	BX	2C1	X7R
Operating temperature	-55°C to +125°C	-55°C to +125°C	-55°C to +125°C
Climatic category	55 / 125 / 56	55 / 125 / 56	55 / 125 / 56
Rated voltage (U _{RC})	10V _{DC} to 500V _{DC}	10V _{DC} to 500V _{DC}	10V _{DC} to 1,000V _{DC}
Maximum ΔC/°C over temperature range without DC voltage applied	±15%	±20%	±15%
Maximum ΔC/°C over temperature range with rated voltage applied	+15% -25%	+20% -30%	NA
Temperature coefficient with or without DC voltage applied	NA	NA	NA
Dielectric withstanding voltage	2.5 U _{RC}	2.5 U _{RC}	2.5 U _{RC} for U _{RC} ≤ 500V _{DC}
Capacitance	at 1MHz for C ≤ 100pF		
	at 1kHz for C > 100pF		
Dissipation factor at 25°C	≤ 2.5% at 1MHz for C ≤ 100pF		
	≤ 2.5% at 1kHz for C > 100pF		
Insulation resistance at 25°C	≥ 100,000 MΩ for C ≤ 10nF		
	under U _{RC} for U _{RC} ≤ 500V _{DC}		
	≥ 1,000 MΩ.µF for C > 10nF under 500V _{DC} for U _{RC} > 500V _{DC}		
Aging	≤ 2.5% per decade hour		

Low and Medium Voltage Chips Capacitors

CEC / CNC Series

DIMENSIONS in inches (mm)

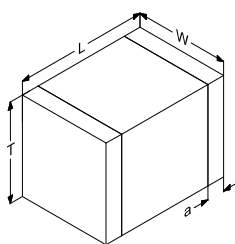

STANDARD RATINGS

Series	CEC/CNC 19				CEC/CNC 17				CEC/CNC 14				
Size	0402				0403				0603				
Dimensions inches (mm)	L	0.039 ± 0.004 (1 ± 0.1)				0.039 ± 0.004 (1 ± 0.1)				0.063 ± 0.006 (1.6 ± 0.15)			
	W	0.02 ± 0.004 (0.5 ± 0.1)				0.03 ± 0.004 (0.76 ± 0.1)				0.032 ± 0.006 (0.8 ± 0.15)			
	a	0.004 min (0.1) min				0.004 min (0.1) min				0.012 ± 0.008 (0.3 ± 0.2)			
	T max.	0.024 (0.6)				0.032 (0.8)				0.04 (1)			
Dielectric	NPO	BX	2C1	X7R	NPO	BX	2C1	X7R	NPO	BX	2C1	X7R	
Min. Cap. value	1pF	68pF			1pF	270pF			1pF	270pF			
Rated voltage (U _{ric})	10V	390pF	15nF	15nF	15nF	1.2nF	47nF	47nF	47nF	3.3nF	120nF	120nF	120nF
	16V	270pF	12nF	12nF	15nF	820pF	39nF	39nF	47nF	2.7nF	120nF	120nF	120nF
	25V	180pF	4.7nF	5.6nF	5.6nF	470pF	15nF	18nF	18nF	1.8nF	56nF	56nF	56nF
	50V	82pF	1.2nF	2.2nF	3.9nF	330pF	3.9nF	5.6nF	12nF	820pF	12nF	18nF	33nF
	63V	68pF	820pF	1.2nF	3.9nF	220pF	2.2nF	3.9nF	12nF	680pF	8.2nF	12nF	33nF
	100V	39pF	330pF	560pF	1.2nF	120pF	1nF	1.8nF	3.3nF	330pF	3.3nF	5.6nF	12nF

Series	CEC/CNC 1				CEC/CNC 2				CEC/CNC 18				CEC/CNC 8						
Size	0504				0805				0907				1005						
Dimensions inches (mm)	L	0.049 ± 0.008 (1.25 ± 0.2)				0.079 ± 0.012 (2 ± 0.3)				0.091 ± 0.012 (2.3 ± 0.3)				0.098 ± 0.012 (2.5 ± 0.3)					
	W	0.039 ± 0.008 (1 ± 0.2)				0.049 ± 0.008 (1.25 ± 0.2)				0.071 ± 0.01 (1.8 ± 0.25)				0.049 ± 0.008 (1.25 ± 0.2)					
	a	0.004 min (0.1) min				0.02 ± 0.012 (0.5 ± 0.3)				0.02 ± 0.012 (0.5 ± 0.3)				0.024 ± 0.016 (0.6 ± 0.4)					
	T max.	0.04 (1)				0.052 (1.3)				0.06 (1.5)				0.052 (1.3)					
Dielectric	NPO	BX	2C1	X7R	NPO	NPO Ext.	BX	2C1	X7R	X7R Ext.	NPO	BX	2C1	X7R	NPO	BX	2C1	X7R	
Min. Cap. value	1pF	270pF			1pF	1nF			1pF	47pF			1pF	33pF					
Rated voltage (U _{ric})	10V	3.3nF	120nF	120nF	120nF	12nF	-	470nF	470nF	470nF	-	18nF	820nF	820nF	820nF	3.3nF	100nF	100nF	100nF
	16V	3.3nF	120nF	120nF	120nF	12nF	-	470nF	470nF	470nF	-	18nF	680nF	680nF	680nF	3.3nF	100nF	100nF	100nF
	25V	1.8nF	56nF	56nF	56nF	6.8nF	-	220nF	220nF	220nF	-	12nF	330nF	390nF	390nF	2.2nF	68nF	68nF	68nF
	50V	1.2nF	15nF	22nF	33nF	3.3nF	-	56nF	82nF	120nF	-	5.6nF	82nF	120nF	150nF	1.8nF	56nF	56nF	56nF
	63V	820pF	8.2nF	15nF	33nF	2.7nF	-	33nF	47nF	120nF	-	4.7nF	56nF	82nF	120nF	1.8nF	39nF	56nF	56nF
	100V	390pF	3.3nF	6.8nF	12nF	1.5nF	-	12nF	27nF	39nF	-	2.7nF	22nF	39nF	68nF	1nF	12nF	18nF	18nF
	Min. Cap. value	-	-	-	-	1pF	-	390pF	-	-	-	1pF	-	330pF	-	1pF	-	330pF	-
	200V	-	-	-	-	390pF	820pF	3.3nF	5.6nF	10nF	22nF	680pF	4.7nF	8.2nF	12nF	390pF	3.9nF	5.6nF	6.8nF
	500V	-	-	-	-	100pF	470pF	-	560pF	1.2nF	5.6nF	180pF	-	1nF	1.5nF	120pF	-	560pF	820pF
	1,000V	-	-	-	-	-	-	-	-	-	-	-	-	-	-	-	-	-	-

STANDARD

CEC / CNC Series

Low and Medium Voltage Chips Capacitors

DIMENSIONS in inches (mm)

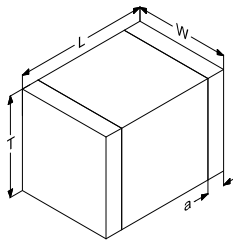

STANDARD RATINGS

Series	CEC/CNC 12								CEC/CNC 4								CEC/CNC 9				CEC/CNC 3				
Size	1206								1210								1605				1806				
Dimensions inches (mm)	L	0.126 ± 0.016 (3.2 ± 0.4)								0.126 ± 0.016 (3.2 ± 0.4)								0.158 ± 0.02 (4 ± 0.5)				0.177 ± 0.02 (4.5 ± 0.5)			
	w	0.063 ± 0.006 (1.6 ± 0.15)								0.098 ± 0.012 (2.5 ± 0.3)								0.05 ± 0.008 (1.25 ± 0.2)				0.063 ± 0.008 (1.6 ± 0.2)			
	a	0.02 ± 0.012 (0.5 ± 0.3)								0.024 ± 0.016 (0.6 ± 0.4)								0.024 ± 0.016 (0.6 ± 0.4)				0.024 ± 0.016 (0.6 ± 0.4)			
	T _{max.}	0.063 (1.6)								0.071 (1.8)								0.05 (1.25)				0.063 (1.6)			
Dielectric	NPO	NPO Ext.	BX	2C1	X7R	X7R Ext.	NPO	NPO Ext.	BX	2C1	X7R	X7R Ext.	NPO	BX	2C1	X7R	NPO	BX	2C1	X7R					
Min. Cap. value	1pF		1.8nF				10pF		2.2nF				10pF		220pF		47pF		390pF						
Rated voltage (U _{ric})	10V	22nF	-	1.2μF	1.2μF	1.2μF	-	56nF	-	2.2μF	2.2μF	2.2μF	-	6.8nF	150nF	150nF	150nF	12nF	330nF	330nF	330nF				
	16V	22nF	-	820nF	1.2μF	1.2μF	-	56nF	-	2.2μF	2.2μF	2.2μF	-	6.8nF	150nF	150nF	150nF	12nF	330nF	330nF	330nF				
	25V	15nF	-	330nF	680nF	680nF	-	39nF	-	1μF	1μF	1μF	-	4.7nF	100nF	100nF	100nF	8.2nF	220nF	220nF	220nF				
	50V	6.8nF	-	150nF	220nF	270nF	-	18nF	-	330nF	470nF	560nF	-	3.9nF	68nF	82nF	82nF	6.8nF	150nF	180nF	180nF				
	63V	6.8nF	-	100nF	150nF	180nF	-	15nF	-	180nF	270nF	560nF	-	3.3nF	56nF	68nF	82nF	5.6nF	100nF	150nF	180nF				
	100V	3.9nF	-	39nF	68nF	120nF	-	8.2nF	-	82nF	150nF	220nF	-	2.2nF	27nF	27nF	33nF	3.9nF	39nF	56nF	56nF				
	Min. Cap. value	1pF		390pF				10pF		470pF				10pF		470pF		47pF		390pF					
	200V	1.2nF	3.3nF	8.2nF	15nF	27nF	68nF	2.2nF	5.6nF	18nF	33nF	56nF	150nF	820pF	6.8nF	10nF	12nF	1.2nF	8.2nF	12nF	18nF				
	500V	330pF	1.5nF	820pF	2.2nF	3.9nF	12nF	680pF	2.7nF	1.8nF	3.9nF	8.2nF	27nF	220pF	-	1.2nF	1.5nF	330pF	820pF	1.8nF	2.7nF				
1,000V	120pF	680pF	-	-	560pF	2.7nF	220pF	1nF	-	-	1.2nF	4.7nF	82pF	-	-	-	120pF	-	-	560pF					

Series	CEC/CNC 6								CEC/CNC 70								CEC/CNC 5				CEC/CNC 7				
Size	1812								1825								2210				2220				
Dimensions inches (mm)	L	0.177 ± 0.02 (4.5 ± 0.5)								0.177 ± 0.020 (4.5 ± 0.5)								0.224 ± 0.02 (5.7 ± 0.5)				0.224 ± 0.02 (5.7 ± 0.5)			
	w	0.126 ± 0.016 (3.2 ± 0.4)								0.250 ± 0.020 (6.35 ± 0.5)								0.098 ± 0.012 (2.5 ± 0.3)				0.197 ± 0.02 (5 ± 0.5)			
	a	0.024 ± 0.016 (0.6 ± 0.4)								0.024 ± 0.020 (0.6 ± 0.4)								0.024 ± 0.016 (0.6 ± 0.4)				0.024 ± 0.016 (0.6 ± 0.4)			
	T _{max.}	0.071 (1.8)								0.071 (1.8)								0.067 (1.7)				0.071 (1.8)			
Dielectric	NPO	NPO Ext.	BX	2C1	X7R	X7R Ext.	NPO	BX	2C1	X7R	NPO	BX	2C1	X7R	NPO	NPO Ext.	BX	2C1	X7R	X7R Ext.					
Min. Cap. value	47pF		3.9nF				100pF		1nF				220pF		1nF		100pF		22nF						
Rated voltage (U _{ric})	10V	82nF	-	4.7μF	4.7μF	4.7μF	-	150nF	4.7μF	4.7μF	4.7μF	39nF	680nF	680nF	680nF	180nF	-	10μF	10μF	10μF	-				
	16V	82nF	-	3.3μF	3.3μF	4.7μF	-	150nF	2.7μF	2.7μF	2.7μF	39nF	680nF	680nF	680nF	180nF	-	8.2μF	8.2μF	10μF	-				
	25V	39nF	-	2.2μF	2.2μF	2.2μF	-	82nF	2.2μF	2.2μF	2.2μF	22nF	470nF	470nF	470nF	82nF	-	4.7μF	4.7μF	4.7μF	-				
	50V	27nF	-	560nF	820nF	1.2μF	-	56nF	1.2μF	1.5μF	1.5μF	18nF	390nF	390nF	390nF	56nF	-	1.2μF	2.2μF	2.7μF	-				
	63V	22nF	-	330nF	470nF	1μF	-	47nF	680nF	1μF	1μF	15nF	330nF	390nF	390nF	47nF	-	820nF	1.5μF	2.7μF	-				
	100V	15nF	-	150nF	270nF	470nF	-	22nF	270nF	560nF	820nF	10nF	100nF	180nF	180nF	33nF	-	270nF	680nF	1μF	-				
	Min. Cap. value	47pF		470pF				82pF		1nF				220pF		1nF		100pF		1.2nF					
	200V	4.7nF	12nF	27nF	47nF	68nF	330nF	8.2nF	56nF	100nF	180nF	3.9nF	27nF	47nF	68nF	10nF	27nF	56nF	120nF	220nF	820nF				
	500V	1.2nF	5.6nF	2.7nF	6.8nF	10nF	82nF	2.2nF	5.6nF	12nF	27nF	1nF	2.7nF	5.6nF	8.2nF	2.7nF	15nF	5.6nF	15nF	27nF	180nF				
1,000V	470pF	2.7nF	-	-	2.2nF	22nF	820pF	-	-	3.9nF	470pF	-	-	1.8nF	1nF	6.8nF	-	-	3.9nF	39nF					

Low and Medium Voltage Chips Capacitors

CEC / CNC Series

DIMENSIONS in inches (mm)

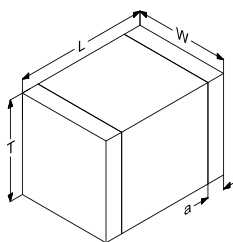

STANDARD RATINGS

Series	CEC/CNC 71				CEC/CNC W				CEC/CNC X				CEC/CNC 72				
Size	2225				2528				3030				3040				
Dimensions inches (mm)	L	0.224 ± 0.02 (5.7 ± 0.5)				0.250 ± 0.020 (6.35 ± 0.5)				0.299 ± 0.02 (7.6 ± 0.5)				0.299 ± 0.02 (7.6 ± 0.5)			
	W	0.250 ± 0.020 (6.35 ± 0.5)				0.276 ± 0.020 (7 ± 0.5)				0.299 ± 0.02 (7.6 ± 0.5)				0.4 ± 0.02 (10.16 ± 0.5)			
	a	0.024 ± 0.020 (0.6 ± 0.4)				0.024 ± 0.020 (0.6 ± 0.4)				0.024 ± 0.016 (0.6 ± 0.4)				0.024 ± 0.016 (0.6 ± 0.4)			
	T max.	0.079 (2)				0.079 (2)				0.079 (2)				0.079 (2)			
Dielectric	NPO	BX	2C1	X7R	NPO	BX	2C1	X7R	NPO	BX	2C1	X7R	NPO	BX	2C1	X7R	
Min. Cap. value	150pF	1.5nF			270pF	2.7nF			390pF	4.7nF			680pF	8.2nF			
Rated voltage (U _{rated})	10V	180nF	5.6µF	5.6µF	5.6µF	220nF	6.8µF	6.8µF	6.8µF	330nF	10µF	10µF	10µF	470nF	12µF	12µF	12µF
	16V	180nF	3.3µF	3.3µF	4.7µF	220nF	3.9µF	3.9µF	3.9µF	330nF	6.8µF	6.8µF	6.8µF	470nF	8.2µF	8.2µF	8.2µF
	25V	100nF	2.2µF	2.2µF	3.9µF	120nF	2.7µF	2.7µF	2.7µF	180nF	3.9µF	3.9µF	3.9µF	270nF	5.6µF	5.6µF	5.6µF
	50V	68nF	1.2µF	1.5µF	2.2µF	82nF	1.5µF	1.8µF	1.8µF	120nF	2.7µF	2.7µF	2.7µF	150nF	3.3µF	3.9µF	3.9µF
	63V	56nF	820nF	1.2µF	1.5µF	68nF	1µF	1.5µF	1.8µF	100nF	1.5µF	2.2µF	2.2µF	120nF	2.2µF	2.7µF	3.3µF
	100V	33nF	390nF	680nF	1.2µF	33nF	390nF	820nF	1.2µF	56nF	680nF	1.2µF	1.5µF	82nF	1µF	1.8µF	2.2µF
	200V	12nF	68nF	120nF	270nF	15nF	82nF	150nF	270nF	22nF	150nF	270nF	470nF	33nF	180nF	390nF	560nF
	500V	3.3nF	5.6nF	15nF	33nF	3.9nF	8.2nF	18nF	33nF	6.8nF	12nF	33nF	68nF	8.2nF	22nF	56nF	100nF
	1,000V	1.2nF	-	-	4.7nF	1.5nF	-	-	5.6nF	2.7nF	-	-	10nF	3.3nF	-	-	15nF

Available capacitance values:

NPO: E6, E12, E24, E48, E96 (see page 14). Specific values upon request.

X7R: E6, E12, E24 (see page 14). Specific values upon request.

The above table defines the standard products, other components may be built upon request.

Other temperature coefficients, temperature characteristic 2B1 and Bismuth free dielectrics are available: contact your sales representative.

STANDARD

Non Magnetic Chips Series

Low and Medium Voltage Chips Capacitors



FEATURES

- Case sizes: 0505 to 2220
- NPO and X7R dielectrics
- Capacitance range: 10pF to 1μF
- Low ESR/ESL (R12N Series)
- RoHS compliant capacitors

PHYSICAL CHARACTERISTICS

MLCC capacitors with:

- Copper barrier + pur Tin or Silver Palladium terminations for surface mounting.

PACKAGING

Sizes	Ag/Pd/Pt termination (A code)	Cu termination (C code)
	Parts / reel *	Parts / reel *
R12N (0505)	-	3,000
R14 (0603)	(C code)	3,000 / 4,000
R15 (0805)	Parts / reel *	Parts / reel *
R18 (1206)	3,000 - 4,000	3,000
S41 (1210)	2,000 - 4,000	1,000 - 2,000 - 3,000
S43 (1812)	500 - 1,000	-
S47 (2220)	500 - 1,000	-

* Note: the quantity of parts in a reel depends upon their thicknesses.
Please, consult us for more accurate data.

ELECTRICAL SPECIFICATIONS

Description	NPO dielectric	X7R dielectric
Dielectric code	N	X
CECC class	1B / CG	2R1
EIA class	Class I	Class II
Temperature range	-55°C to +125°C	-55°C to +125°C
Temperature coefficient	(0±30) ppm/°C	NA
Maximum ΔC/°C over temperature range without DC voltage applied	NA	±15%
Rated voltage (U _R)	50V _{DC} to 500V _{DC}	63V _{DC} to 500V _{DC}
Dielectric withstanding voltage	250% rated voltage	250% rated voltage
Insulation resistance (I _R) at 25°C under U _R	100GΩ or 1,000Ω.F whichever is less	100GΩ or 1,000Ω.F whichever is less
Aging	None	≤ 2.5% per decade hour

HOW TO ORDER

630	S41	N	472	J	C	E
Rated voltage	Exxelia Size Code	Dielectric code	Capacitance	Tolerance	Termination	Packaging
500 = 50V 630 = 63V 101 = 100V 151 = 150V 201 = 200V 501 = 500V	R12 = 0505 R14 = 0603 R15 = 0805 R18 = 1206 S41 = 1210 S43 = 1812 S47 = 2220	N = NPO X = X7R	Capacitance value in code. 1 st two digits represent significant figures; last digit specifies the number of zeros to follow. Examples: 101 = 100pF 472 = 4.7nF 683 = 68nF 564 = 0.56μF 105 = 1μF	NPO: F = ±1% G = ±2% J = ±5% K = ±10% M = ±20% X7R: K = ±10% M = ±20%	C = Pure Tin plated Copper barrier on Pure Silver termination A = Silver Palladium Platinum termination	- = Bulk E = tape & reel (see packaging paragraph for details) See page 13

DIMENSIONS in inches (mm)

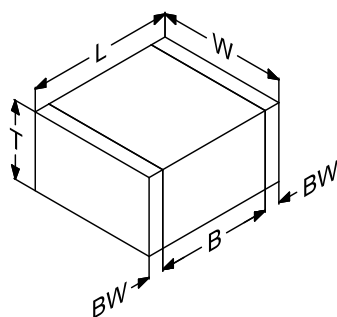

STANDARD RATINGS

Size		0505		0603		0805				1206					
Exxelia size code		R12N <small>NEW</small>		R14		R15				R18					
Termination code		C		C		A		C		A		C		A	
Dimensions inches (mm)	L	0.055 ± 0.010 (1.4 ± 0.25)		0.063 ± 0.012 (1.6 ± 0.3)		0.063 ± 0.012 (1.6 ± 0.3)		0.079 ± 0.012 (2 ± 0.3)		0.079 ± 0.012 (2 ± 0.3)		0.126 ± 0.012 (3.2 ± 0.3)		0.126 ± 0.012 (3.2 ± 0.3)	
	W	0.055 ± 0.010 (1.4 ± 0.25)		0.032 ± 0.008 (0.8 ± 0.2)		0.032 ± 0.008 (0.8 ± 0.2)		0.049 ± 0.012 (1.25 ± 0.3)		0.049 ± 0.012 (1.25 ± 0.3)		0.063 ± 0.012 (1.6 ± 0.3)		0.063 ± 0.012 (1.6 ± 0.3)	
	B min.	0.019 (0.5)		0.015 (0.4)		0.015 (0.4)		0.027 (0.7)		0.019 (0.5)		0.059 (1.5)		0.055 (1.4)	
	BW min.	0.004 (0.1)		0.005 (0.15)		0.005 (0.15)		0.007 (0.2)		0.005 (0.13)		0.011 (0.3)		0.009 (0.25)	
	T max.	0.055 (1.4)		0.038 (0.95)		0.038 (0.95)		0.058 (1.45)		0.058 (1.45)		0.071 (1.80)		0.071 (1.80)	
Dielectric		NPO		NPO	X7R	NPO	X7R	NPO	X7R	NPO	X7R	NPO	X7R	NPO	X7R
		N		N	X	N	X	N	X	N	X	N	X	N	X
Rated voltage (U _{RC})	50V	680pF to 1nF		-	-	-	-	-	-	-	-	-	-	-	-
	63V	-	-	470pF to 15pF		-	4.7nF to 22nF	-	680pF to 22nF	-	10nF to 47nF	-	1nF to 100nF	-	15nF to 100nF
	100V	-	-	47pF to 180pF	-	-	-	47pF to 1nF	-	220pF to 1nF	-	100pF to 2.2nF	-	220pF to 2.2nF	-
	150V	120pF to 620pF		-	-	-	-	-	-	-	-	-	-	-	-
	200V	-	-	-	-	-	-	-	10pF to 220pF	330pF to 4.7nF	-	-	10pF to 1nF	1nF to 10nF	-
	500V	-	-	-	-	-	-	-	10pF to 180pF	270pF to 2.2nF	-	-	10pF to 470pF	680pF to 4.7nF	-

Size		1210				1812				2220			
Exxelia size code		S41				S43				S47			
Termination code		C		A		C		A		C		A	
Dimensions inches (mm)	L	0.126 ± 0.016 (3.2 ± 0.4)		0.126 ± 0.016 (3.2 ± 0.4)		-		0.177 ± 0.02 (4.5 ± 0.5)		-		0.224 ± 0.02 (5.7 ± 0.5)	
	W	0.098 ± 0.012 (2.5 ± 0.3)		0.098 ± 0.012 (2.5 ± 0.3)		-		0.126 ± 0.016 (3.2 ± 0.4)		-		0.197 ± 0.02 (5 ± 0.5)	
	B min.	0.062 (1.6)		0.055 (1.4)		-		0.086 (2.2)		-		0.114 (2.9)	
	BW min.	0.011 (0.3)		0.009 (0.25)		-		0.009 (0.25)		-		0.009 (0.25)	
	T max.	0.103 (2.6)		0.099 (2.5)		-		0.119 (3)		-		0.119 (3)	
Dielectric		NPO	X7R	NPO	X7R	NPO	X7R	NPO	X7R	NPO	X7R	NPO	X7R
		N	X	N	X	N	X	N	X	N	X	N	X
Rated voltage (U _{RC})	63V	-	3.3nF to 100nF	-	33nF to 330nF	-	150nF to 1µF	-	150nF to 1µF	-	330nF to 1µF	-	330nF to 1µF
	100V	100pF to 4.7nF	-	470pF to 5.6nF	-	1.8nF to 5.6nF	-	1.8nF to 5.6nF	-	6.8nF to 10nF	-	6.8nF to 10nF	-
	200V	-	-	100pF to 2.7nF	1.5nF to 47nF	180pF to 5.6nF	2.7nF to 100nF	180pF to 5.6nF	2.7nF to 100nF	680pF to 10nF	6.8nF to 220nF	680pF to 10nF	6.8nF to 220nF
	500V	-	-	100pF to 1nF	1.5nF to 22nF	180pF to 2.2nF	2.7nF to 47nF	180pF to 2.2nF	2.7nF to 47nF	680pF to 4.7nF	6.8nF to 100nF	680pF to 4.7nF	6.8nF to 100nF

Available capacitance values:

E6, E12 (see page 14). Specific values upon request.

Note: some capacitance values in these tables may not be proposed for small quantities. Please, contact us for confirmation.

OP Series

Open Mode Chips Capacitors

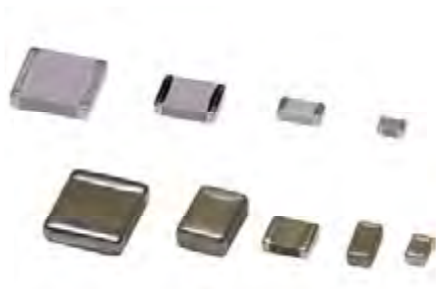

FEATURES

- Case sizes: 0805 to 2220
- NPO and X7R dielectrics
- Capacitance range: 1pF to 4.7μF
- Designed to significantly minimize the probability of short circuit or low IR failure due to board flexion
- Ag/Pd/Pt, Ni barrier, epoxy terminations available
- RoHS and Non RoHS compliant capacitors available
- Screening in accordance with ESA specifications available

PHYSICAL CHARACTERISTICS

CONSTRUCTION

MLCC capacitors for surface mounting with optional Nickel barrier

MARKING (on request)

Capacitance value code

ELECTRICAL SPECIFICATIONS

Description	NPO	X7R
Operating temperature	-55°C to +125°C*	-55°C to +125°C*
Climatic category	55 / 125 / 56	55 / 125 / 56
Rated voltage (U _{RC})	10V _{DC} to 100V _{DC}	10V _{DC} to 100V _{DC}
Maximum ΔC/°C over temperature range without DC voltage applied	NA	±15%
Temperature coefficient with or without DC voltage applied	(0±30)ppm/°C	NA
Dielectric withstanding voltage	2.5 U _{RC}	2.5 U _{RC}
Capacitance	at 1MHz for C ≤ 1,000pF at 1kHz for C > 1,000pF	at 1MHz for C ≤ 100pF at 1kHz for C > 100pF
Dissipation factor at 25°C	≤ 0.015 (150/C + 7)% at 1MHz for C ≤ 50pF	≤ 2.5% at 1MHz for C ≤ 100pF ≤ 2.5% at 1kHz for C > 100pF
	≤ 0.15% at 1MHz for 50pF < C ≤ 1,000pF ≤ 0.15% at 1kHz for C > 1,000pF	
Insulation resistance at 25°C under U _{RC}	≥ 100,000 MΩ for C ≤ 10nF ≥ 1,000 MΩ.μF for C > 10nF	≥ 100,000 MΩ for C ≤ 10nF ≥ 1,000 MΩ.μF for C > 10nF
Aging	None	≤ 2.5% per decade hour

Other temperature coefficients, temperature characteristics 2B1, BX, BR and Bismuth free dielectrics are available.

* Operating temperature up to 250°C available upon request. Contact your sales representative.

HOW TO ORDER

OP	1210	X7R	C	M	F	270nF	10%	50V	S8	T5
Series	Size	Dielectric	Termination	Marking	Quality level	Capacitance	Tolerance	Rated voltage	Packaging	Reliability level
OP: Open-mode	0805 1206 1210 1812 2220	NPO X7R	W = RoHS compliant - Ag/Pd/Pt Q Ag* H Ag/Pd/Pt + dipped Sn/Pb 60/40 C Ag + Ni** + electrolytic Sn/Pb 95/5 D Ag + Ni*** + electrolytic Sn/Pb 60/40 G Ag + Ni + Au YC Ag + Polymer + Ni + Sn/Pb 95/5 YD Ag + Polymer + Ni + Sn/Pb 60/40 YG Ag + Polymer + Ni + Au	- = no marking M = Marking: capacitance value coded (from 0805 to 3040 sizes).	- = standard quality level F = Hi-Rel quality: screening in accordance with Exxelia specification	Capacitance value in clear	NPO: cap. value ≤ 12pF ±0.25pF cap. value ≤ 8.2pF ±0.5pF ±1pF cap. value > 22pF ±1% cap. value > 12pF ±2% cap. value > 8.2pF ±5% ±10% cap. value > 3.9pF ±20% X7R: ±5% ±10% ±20%	10V 16V 25V 50V 100V Intermediary and higher voltages available on request.	- = Exxelia packaging S8* = available for 0402 to 1210 sizes. S12* = available for 1812 to 2220 sizes. BA* = available for 0402 to 2220 (except 0907) sizes. * not available with H, HW and E, terminations See page 13	For F parts only. Acc. to Exxelia spec. - T5 T6 See page 15

Open Mode Chips Capacitors

OP Series

DIMENSIONS in inches (mm)

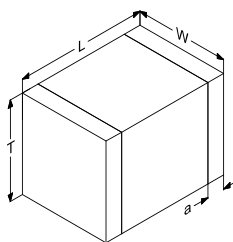

L, W, T for tinned chips (H, HW): +0.02" (+0.5mm)

STANDARD RATINGS

Size	0805		1206		1210		1812		2220		
Dimensions inches (mm)	L	0.079 ± 0.012 (2 ± 0.3)	0.126 ± 0.01 (3.2 ± 0.25)	0.126 ± 0.016 (3.2 ± 0.4)	0.177 ± 0.02 (4.5 ± 0.5)	0.224 ± 0.02 (5.7 ± 0.5)					
	W	0.049 ± 0.008 (1.25 ± 0.2)	0.063 ± 0.006 (1.6 ± 0.15)	0.098 ± 0.012 (2.5 ± 0.3)	0.126 ± 0.016 (3.2 ± 0.4)	0.197 ± 0.02 (5 ± 0.5)					
	a	0.02 ± 0.012 (0.5 ± 0.3)	0.02 ± 0.012 (0.5 ± 0.3)	0.024 ± 0.016 (0.6 ± 0.4)	0.024 ± 0.016 (0.6 ± 0.4)	0.024 ± 0.016 (0.6 ± 0.4)					
	T max.	0.052 (1.3)	0.063 (1.6)	0.071 (1.8)	0.071 (1.8)	0.079 (2)					
Dielectric	NPO	X7R	NPO	X7R	NPO	X7R	NPO	X7R	NPO	X7R	
Min. Cap. value	1pF	390pF	1pF	1nF	10pF	1nF	47pF	1.8nF	100pF	8.2nF	
Rated voltage (U _{RC})	10V	5.6nF	270nF	18nF	820nF	27nF	1.5µF	47nF	2.7µF	120nF	4.7µF
	16V	5.6nF	220nF	18nF	680nF	27nF	1.2µF	47nF	2.2µF	120nF	3.9µF
	25V	3.3nF	120nF	10nF	330nF	15nF	560nF	27nF	1µF	56nF	2.2µF
	50V	1.8nF	68nF	4.7nF	150nF	6.8nF	330nF	12nF	680nF	27nF	1.5µF
	63V	1.5nF	39nF	3.9nF	82nF	5.6nF	180nF	10nF	390nF	22nF	820nF
	100V	820pF	18nF	1.8nF	47nF	2.7nF	100nF	5.6nF	180nF	12nF	470nF

Available capacitance values:

NPO: E6, E12, E24, E48, E96 (See page 14). Specific values upon request.

X7R: E6, E12, E24 (See page 14). Specific values upon request.

The above table defines the standard products, other components may be built upon request.

Other temperature coefficients, temperature characteristic 2B1 and Bismuth free dielectrics are available: contact your sales representative.



FEATURES

- Low inductance due to their electrodes geometry which allow an increase of the working frequency
- Case sizes: 0306 to 0612
- NPO and X7R dielectrics
- Capacitance range: 1pF to 270nF
- Ag/Pd/Pt, Ni barrier, epoxy terminations available
- RoHS and Non RoHS compliant capacitors available
- Screening in accordance with ESA specifications available

PHYSICAL CHARACTERISTICS

CONSTRUCTION

MLCC capacitors for surface mounting with optional Nickel barrier

MARKING (on request)

Capacitance value coded

ELECTRICAL SPECIFICATIONS

Description	NPO	X7R
Operating temperature	-55°C to +125°C	-55°C to +125°C
Climatic category	55 / 125 / 56	55 / 125 / 56
Rated voltage (U_{RC})	16V _{DC} to 100V _{DC}	16V _{DC} to 100V _{DC}
Maximum $\Delta C/^\circ C$ over temperature range without DC voltage applied	NA	±15%
Temperature coefficient with or without DC voltage applied	(0±30)ppm/°C	NA
Dielectric withstanding voltage	2.5 U_{RC}	2.5 U_{RC}
Capacitance	at 1MHz for C ≤ 1,000pF at 1kHz for C > 1,000pF	at 1kHz
Dissipation factor at 25°C	≤ 0.015 (150/C + 7)% at 1MHz for C ≤ 50pF ≤ 0.15% at 1MHz for 50pF < C ≤ 1,000pF ≤ 0.15% at 1kHz for C > 1,000pF	≤ 2.5% at 1kHz
Insulation resistance at 25°C under U_{RC}	≥ 100,000 MΩ	≥ 100,000 MΩ for C ≤ 10nF ≥ 1,000 MΩ.μF for C > 10nF
Aging	None	≤ 2.5% per decade hour

HOW TO ORDER

CER	2	C	560pF	10%	50V
Series/Dielectric	Exxelia size code	Termination	Capacitance	Tolerance	Rated voltage
CER = NPO CNR = X7R	14 = 0306 2 = 0508 12 = 0612	- Ag/Pd/Pt W Ag/Pd/Pt (RoHS) C Ag + Ni + electrolytic Sn/Pb 95/5 CW Ag + Ni + electrolytic Sn (RoHS) D Ag + Ni + electrolytic Sn/Pb 60/40 G Ag + Ni + Au GW Ag + Ni + Au (RoHS) YC Ag + Polymer + Ni + Sn/Pb 95/5 YCW Ag + Polymer + Ni + Sn (RoHS) YD Ag + Polymer + Ni + Sn/Pb 60/40 YG Ag + Polymer + Ni + Au YGW Ag + Polymer + Ni + Au (RoHS)	Capacitance value in clear	NPO: cap. value ≤ 12pF ±0.25pF cap. value ≤ 8.2pF ±0.5pF ±1pF cap. value > 22pF ±1% cap. value > 12pF ±2% cap. value > 8.2pF ±5% ±10% cap. value > 3.9pF ±20% X7R: ±5% ±10% ±20%	16V 25V 50V 100V Intermediary and higher voltages available on request.

DIMENSIONS in inches (mm)

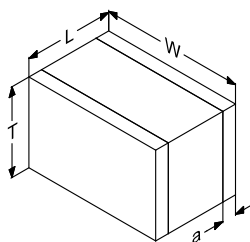

STANDARD

STANDARD RATINGS

Size	0306		0508		0612		
Excellia size code	14		2		12		
Dimensions inches (mm)	L	0.032 ± 0.01 (0.8 ± 0.25)		0.049 ± 0.012 (1.25 ± 0.3)		0.063 ± 0.01 (1.6 ± 0.25)	
	W	0.063 ± 0.008 (1.6 ± 0.2)		0.079 ± 0.012 (2 ± 0.3)		0.126 ± 0.01 (3.2 ± 0.25)	
	a	0.004 min (0.1 min)		0.004 min (0.1 min)		0.012 ± 0.008 (0.3 ± 0.2)	
	T max.	0.04 (1)		0.05 (1.25)		0.063 (1.6)	
Dielectric	NPO	X7R	NPO	X7R	NPO	X7R	
	CER	CNR	CER	CNR	CER	CNR	
Min. Cap. value	1pF	270pF	1pF	1nF	1pF	1.8nF	
Rated voltage (U _{RC})	16V	820pF	22nF	2.7nF	100nF	10nF	270nF
	25V	680pF	15nF	2.2nF	68nF	8.2nF	180nF
	50V / 63V	470pF	15nF	1.2nF	68nF	4.7nF	120nF
	100V	270pF	4.7nF	820pF	22nF	2.7nF	39nF

Available capacitance values:

NPO: E6, E12, E24, E48, E96 (See page 14). Specific values upon request.

X7R: E6, E12, E24 (See page 14). Specific values upon request.

The above table defines the standard products, other components may be built upon request.

C3N / C4N / C3E / C4E Series

Capacitors Arrays



FEATURES

- Space saving with multiple capacitors in the same package
- NPO and X7R dielectrics
- Capacitance range: 4.7pF to 3.3nF
- Ag/Pd/Pt, Ni barrier, epoxy terminations available
- RoHS and Non RoHS compliant capacitors available

PHYSICAL CHARACTERISTICS

MLCC capacitors for surface mounting with optional Nickel barrier

ELECTRICAL SPECIFICATIONS

Description	NPO	X7R
Operating temperature	-55°C to +125°C	-55°C to +125°C
Climatic category	55 / 125 / 56	55 / 125 / 56
Rated voltage (U _{RC})	25V _{DC} to 200V _{DC}	25V _{DC} to 200V _{DC}
Dielectric withstanding voltage at 25°C	2.5 U _{RC}	2.5 U _{RC}
Capacitance	at 1MHz for C ≤ 1,000pF at 1kHz for C > 1,000pF	at 1MHz for C ≤ 100pF at 1kHz for C > 100pF
Dissipation factor at 25°C	≤ 0.015 (150/C + 7)% at 1MHz for C ≤ 50pF ≤ 0.15% at 1MHz for 50pF < C ≤ 1,000pF	≤ 2.5% at 1kHz for C > 100pF
Insulation resistance at 25°C under U _{RC}	≥ 50,000MΩ	≥ 20,000MΩ
Aging	None	≤ 2.5% per decade hour

DIMENSIONS in inches [mm]

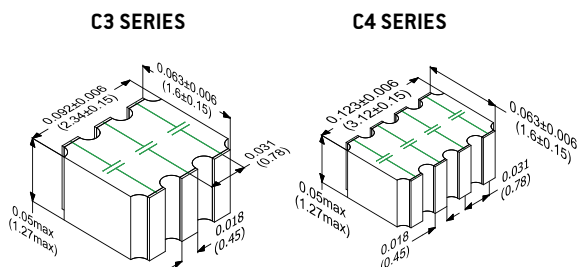

Black lines: mechanical - Green lines: electrical

STANDARD RATINGS

Dielectric	NPO	X7R
Dielectric code	E	N
Min Capacitance value	4.7pF	100pF
Rated voltage (U _{RC})	25V	680pF
	50V	390pF
	100V	270pF
	200V	120pF
		3.3nF

Capacitance values of each capacitor of the array are the same. They can be different upon request.

Available capacitance values:

NPO: E6, E12, E24, E48, E96 (See page 14). Specific values upon request.

X7R: E6, E12, E24 (See page 14). Specific values upon request.

The above table defines the standard products, other components may be built upon request.

HOW TO ORDER

C4	N	C	1.5nF	10%	100V
Series	Dielectric	Termination	Capacitance	Tolerance	Rated voltage
C3 = 3 capacitors per array C4 = 4 capacitors per array	E = NPO N = X7R	- Ag/Pd/Pt W Ag/Pd/Pt (RoHS) C Ag + Ni + electrolytic Sn/Pb 95/5 CW Ag + Ni + electrolytic Sn (RoHS) D Ag + Ni + electrolytic Sn/Pb 60/40 G Ag + Ni + Au GW Ag + Ni + Au (RoHS)	Capacitance value in clear	NPO: ±0.25pF (cap. value < 15pF) ±0.5pF (cap. value < 10pF) ±1pF (cap. value < 10pF) ±1% (cap. value ≥ 27pF) ±2% (cap. value ≥ 15pF) ±5% (cap. value ≥ 10pF) ±10% (cap. value ≥ 10pF) ±20% (cap. value ≥ 10pF) X7R: ±5% ±10% ±20%	25V 50V 100V 200V Intermediary and higher voltages available on request.



FEATURES

- 4 terminals security capacitors
- Detection of the open circuits
- NPO and X7R dielectrics
- Capacitance range: 470pF to 820nF
- Ag/Pd/Pt, tinned terminations, ribbon connections available
- RoHS and Non RoHS compliant capacitors available

PHYSICAL CHARACTERISTICS

MLCC capacitors for surface mounting with optional Nickel barrier or ribbon connections

DIMENSIONS in inches (mm)

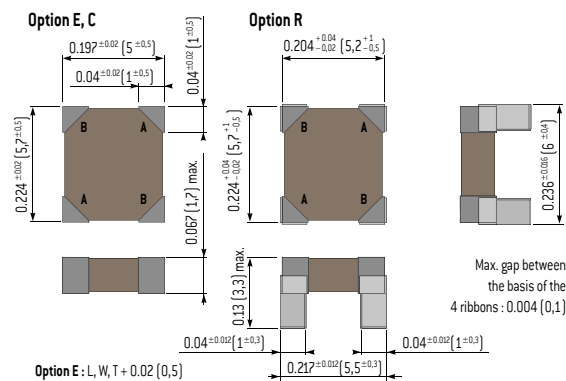

ELECTRICAL SPECIFICATIONS

Description	NPO	X7R
Operating temperature	-55°C to +125°C	-55°C to +125°C
Climatic category	55 / 125 / 56	55 / 125 / 56
Rated voltage (U _{RC})	40V _{DC} to 100V _{DC}	40V _{DC} to 100V _{DC}
Dielectric withstanding voltage at 25°C	2.5 U _{RC}	2.5 U _{RC}
Capacitance	at 1MHz for C ≤ 1,000pF at 1kHz for C > 1,000pF	at 1MHz for C ≤ 100pF at 1kHz for C > 100pF
Dissipation factor at 25°C	≤0.15% at 1MHz for C ≤ 1,000pF ≤0.15% at 1kHz for C > 1,000pF	≤2.5% at 1kHz
Insulation resistance at 25°C under U _{RC}	≥ 100,000MΩ	≥ 20,000MΩ for C ≤ 25nF ≥ 500MΩ.μF for C > 25nF
Aging	None	≤ 2.5% per decade hour

STANDARD RATINGS

Dielectric	NPO	X7R
Series	1 30 S4	2 30 S4
Min Capacitance value	470pF	3.3nF
Rated voltage (U _{RC})	40V	39nF
	63V	22nF
	100V	10nF

Available capacitance values:
 NPO: E6, E12, E24, E48, E96 (See page 14). Specific values upon request.
 X7R: E6, E12, E24 (See page 14). Specific values upon request.
 The above table defines the standard products, other components may be built upon request.

HOW TO ORDER

130S4	C	M	1.5nF	10%	63V
Series/Dielectric	Termination	Marking	Capacitance	Tolerance	Rated voltage
1 30 S4 = NPO 2 30 S4 = X7R	- Ag/Pd/Pt W Ag/Pd/Pt (RoHS) C Ag + Ni + electrolytic Sn/Pb 95/5 CW Ag + Ni + electrolytic Sn (RoHS) R Solderable ribbons RW Solderable ribbons (RoHS)	For Ag/Pd/Pt, E, C terminations: - = No marking M = Marking Systematic marking for ribbon terminations	Capacitance value in clear	NPO: ±1% ±2% ±5% ±10% ±20% X7R: ±10% ±20%	40V 63V 100V Intermediary and higher voltages available on request.

TCE / TCX / TCN / TXR Molded Series

Radial Molded Capacitors

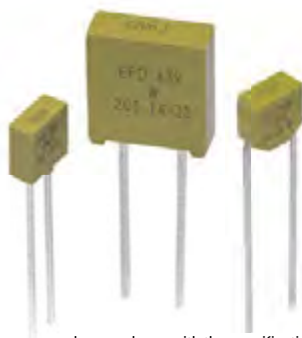

In accordance with the specifications of CECC 30700 and NF C 83132 standards

FEATURES

- Radial molded capacitors
- NPO, BX, 2C1, X7R dielectrics
- Capacitance range: 0.5pF to 4.7μF
- RoHS and Non RoHS compliant capacitors available

PHYSICAL CHARACTERISTICS

CONSTRUCTION

Leaded MLCC capacitors for through-hole mounting:
Epoxy molded capacitors

MARKING

Capacitance, tolerance, voltage, dielectric, date code.

TCN 50/60 R : Enhanced reliability types of TCN 50 A and TCN 60 A.

ELECTRICAL SPECIFICATIONS

Description	NPO	BX	2C1	X7R
Dielectric code	CE	CX	CN	XR
Operating temperature	-55°C to +125°C			
Climatic category	55 / 125 / 56			
Rated voltage (U _{RC})	25V _{DC} to 500V _{DC}			
Max. ΔC/°C over temperature range without DC voltage applied	NA	±15%	±20%	±15%
Maximum ΔC/°C over temperature range with rated voltage applied	NA	+15% -25%	+20% -30%	NA
Temperature coefficient with or without DC voltage applied	(0±30)ppm/°C	NA	NA	NA
Dielectric withstanding voltage	2.5 U _{RC}			
Capacitance	at 1MHz for C ≤ 1,000pF at 1kHz for C > 1,000pF		at 1MHz for C ≤ 100pF at 1kHz for C > 100pF	
Dissipation factor at 25°C	≤ 0.015 (150/C + 7)% at 1MHz for C ≤ 50pF ≤ 0.15% at 1MHz for 50pF < C ≤ 1,000pF ≤ 0.15% at 1kHz for C > 1,000pF		≤ 2.5% at 1MHz for C ≤ 100pF ≤ 2.5% at 1kHz for C > 100pF	
Insulation resistance at 25°C	≥ 100,000 MΩ for C ≤ 10nF ≥ 1,000 MΩ.μF for C > 10nF			
Aging	None		≤ 2.5% per decade hour	

HOW TO ORDER

T	CE	61	A	W	F	6.8nF	10%	25V	B	-
Series	Dielectric	Size	Bismuth	RoHS compliant	Quality level	Capacitance	Tolerance	Rated voltage	Packaging	Reliability level
T = Radial leaded, molded capacitor	CE = NPO CX = BX CN = 2C1 XR = X7R	50 60 61 61N 62 62N 63 64	-- For all models A = Bismuth free for 50/60 sizes only (tg δ at -55°C ≤ 350.10 ⁻⁴)	-- No RoHS W = RoHS compliant	-- standard quality level F = Hi-Rel quality: screening in accordance with Exxelia specification	Capacitance value in clear	NPO: cap. value ≤ 12pF ±0.25pF cap. value ≤ 8.2pF ±0.5pF ±1pF cap. value > 22pF ±1% cap. value > 12pF ±2% cap. value > 8.2pF ±5% ±10% cap. value > 3.9pF ±20% Available for BX, 2C1 and X7R: ±5% ±10% ±20%	25V 50V 100V 200V 500V Intermediary and higher voltages available on request.	-- Exxelia packaging Available for quantity ≥ 500: B = reel	For F parts only. Acc. to Exxelia spec. - T5 T6 See page 15

Radial Molded Capacitors

TCE / TCX / TCN / TXR Molded Series

DIMENSIONS in inches (mm)

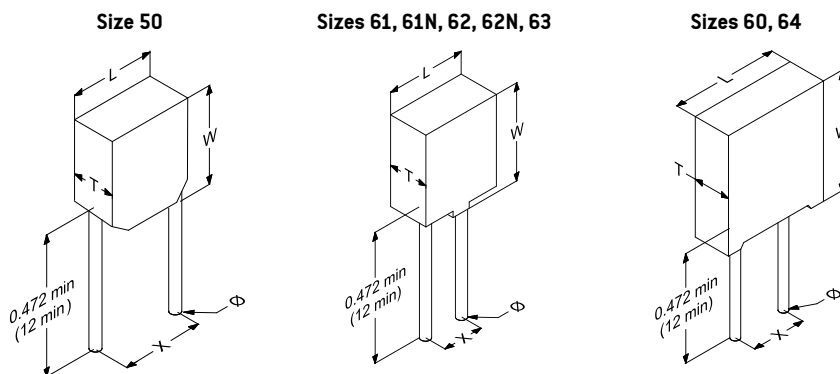

STANDARD RATINGS

Size	61				61N				62				62N				63				64												
Dimensions inches (mm)	L	0.138 ± 0.02 (3.5 ± 0.5)								0.197 ± 0.02 (5 ± 0.5)								0.295 ± 0.02 (7.5 ± 0.5)								0.394 ± 0.02 (10 ± 0.5)							
	W	0.178 max (4.5 max)								0.237 max (6 max)								0.335 max (8.5 max)								0.434 max (11 max)							
	T	0.098 ± 0.008 (2.5 ± 0.2)								0.098 (2.5 ± 0.2)								0.098 (2.5 ± 0.2)								0.138 (3.5)							
	X	0.1 ± 0.008 (2.54 ± 0.2)				0.2 ± 0.008 (5.08 ± 0.2)				0.1 ± 0.008 (2.54 ± 0.2)				0.2 ± 0.008 (5.08 ± 0.2)				0.2 ± 0.008 (5.08 ± 0.2)				0.2 ± 0.008 (5.08 ± 0.2)											
	Ø ± 10%	0.024 (0.6)								0.024 (0.6)								0.024 (0.6)								0.031 (0.8)							
Dielectric	NPO	BX	2C1	X7R	NPO	BX	2C1	X7R	NPO	BX	2C1	X7R	NPO	BX	2C1	X7R	NPO	BX	2C1	X7R													
Dielectric code	CE	CX	CN	XR	CE	CX	CN	XR	CE	CX	CN	XR	CE	CX	CN	XR	CE	CX	CN	XR													
Min. Cap. value	1pF				27pF				1pF				33pF				4.7pF				220pF				4.7nF								
Rated voltage (U _{RC})	25V	6.8nF	220nF	220nF	220nF	33nF	820nF	1µF	1µF	68nF	1.8µF	1.8µF	1.8µF	180nF	4.7µF	4.7µF	4.7µF																
	50V	3.3nF	56nF	82nF	100nF	15nF	220nF	390nF	470nF	47nF	1µF	1.2µF	1.2µF	120nF	2.7µF	3.9µF	3.9µF																
	63V	2.7nF	33nF	47nF	68nF	12nF	150nF	220nF	330nF	39nF	560nF	1µF	1µF	100nF	1.8µF	2.7µF	2.7µF																
	100V	1.5nF	12nF	22nF	39nF	6.8nF	56nF	120nF	180nF	18nF	220nF	470nF	680nF	56nF	680nF	1.2µF	1.8µF																
	200V	390pF	3.3nF	5.6nF	10nF	1.8nF	15nF	27nF	47nF	6.8nF	56nF	100nF	180nF	22nF	180nF	330nF	560nF																
	250V	270pF	1.8nF	3.9nF	6.8nF	1.2nF	8.2nF	18nF	27nF	4.7nF	33nF	68nF	120nF	15nF	100nF	220nF	330nF																
	500V	100pF	-	560pF	1.2nF	470pF	-	3.3nF	4.7nF	2.2nF	-	10nF	22nF	6.8nF	-	47nF	82nF																

Size	50				60												
Dimensions inches (mm)	L	0.197 ± 0.02 (5 ± 0.5)								0.295 ± 0.02 (7.5 ± 0.5)							
	W	0.197 ± 0.008 (5 ± 0.2)								0.295 ± 0.008 (7.5 ± 0.2)							
	T	0.098 max. (2.5 max.)								0.098 max. (2.5 max.)							
	X	0.2 ± 0.008 (5.08 ± 0.2)				0.2 ± 0.008 (5.08 ± 0.2)				0.2 ± 0.008 (5.08 ± 0.2)				0.2 ± 0.008 (5.08 ± 0.2)			
	Ø ± 10%	0.024 (0.6)								0.024 (0.6)							
Dielectric	NPO		BX		2C1		X7R		NPO		BX		2C1		X7R		
Dielectric code	CE		CX		CN		XR		CE		CX		CN		XR		
Min. Cap. value	1pF		10pF		10pF		10pF		4.7pF		330pF		330pF		330pF		
Rated voltage (U _{RC})	25V	27nF	820nF	820nF	820nF	56nF	1.5µF	1.5µF	1.5µF								
	50V	12nF	220nF	270nF	390nF	39nF	1µF	1µF	1µF								
	63V	10nF	120nF	180nF	270nF	27nF	470nF	1µF	820nF								
	100V	5.6nF	47nF	100nF	150nF	15nF	180nF	390nF	560nF								
	200V	1.5nF	12nF	22nF	39nF	5.6nF	39nF	82nF	150nF								
	250V	1.2nF	6.8nF	15nF	27nF	3.9nF	27nF	56nF	100nF								
	500V	390pF	-	1.8nF	4.7nF	1.5nF	-	8.2nF	15nF								

Available capacitance values:

NPO: E6, E12, E24, E48, E96 (see page 14). Specific values upon request.

X7R: E6, E12, E24 (see page 14). Specific values upon request.

The above table defines the standard products, other components may be built upon request.

STANDARD

LA Series

Radial Molded Capacitors



FEATURES

- Radial molded capacitors
- Temperature coefficients : 0 ± 30.10^{-6}
 -750.10^{-6}
 -1500.10^{-6}
- Capacitance range: 1pF to 680nF
- RoHS and Non RoHS compliant capacitors available

PHYSICAL CHARACTERISTICS

CONSTRUCTION

Leaded MLCC capacitors for through-hole mounting:
 Epoxy molded capacitors

MARKING

Capacitance, tolerance, voltage, dielectric, date code.

ELECTRICAL SPECIFICATIONS

Temperature coefficient	0 ± 30.10^{-6}	-750.10^{-6}
Operating temperature	-55°C to +125°C	
Climatic category	55 / 125 / 56	
Rated voltage (U_{RC})	25V _{DC} to 63V _{DC}	
Dielectric withstanding voltage	2.5 U_{RC}	
Dissipation factor at 1kHz at 25°C	$\leq 10.10^{-4}$	$\leq 100.10^{-4}$
Insulation resistance at 25°C	$\geq 50,000 \text{ M}\Omega$ for $C \leq 1\text{nF}$ $\geq 50 \text{ M}\Omega.\mu\text{F}$ for $C > 1\text{nF}$	

HOW TO ORDER

LA	1	W	F	10pF	10%	50V	B	-
Series	Size	RoHS compliant	Quality level	Capacitance	Tolerance	Rated voltage	Packaging	Reliability level
LA = Radial leaded, molded capacitor	1 2 3 4 5A 5B 5C	- = No RoHS W = RoHS compliant	- = standard quality level F = Hi-Rel quality: screening in accordance with Exxelia specification	Capacitance value in clear	0 ± 30.10^{-6} : cap. value $\leq 10\text{pF}$ $\pm 0.25\text{pF}$ cap. value $\leq 6.8\text{pF}$ $\pm 0.5\text{pF}$ $\pm 1\text{pF}$ cap. value $> 22\text{pF}$ $\pm 1\%$ cap. value $> 10\text{pF}$ $\pm 2\%$ cap. value $> 6.8\text{pF}$ $\pm 5\%$ $\pm 10\%$ cap. value $> 3.3\text{pF}$ $\pm 20\%$ Available for -750.10^{-6} and -1500.10^{-6} : $\pm 10\%$ $\pm 20\%$	25V 50V 63V Intermediary and higher voltages available on request.	- = Exxelia packaging Available for quantity ≥ 500 : B = reel	For F parts only. Acc. to Exxelia spec. - T5 T6 See page 15

Radial Molded Capacitors

LA Series

DIMENSIONS in inches (mm)

Sizes 1, 2, 3, 4, 5A, 5B, 5C

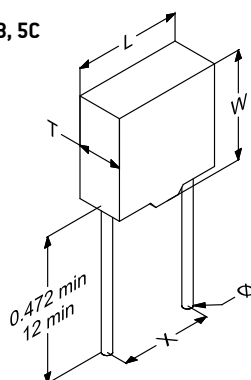

STANDARD RATINGS

Size	1		2		3		4	
Dimensions Inches (mm)	L max	0.178 (4.5)	0.197 (5)	0.237 (6)	0.319 (8.1)			
	W max	0.158 (4)	0.178 (4.5)	0.237 (6)	0.319 (8.1)			
	T max	0.107 (2.7)	0.119 (3)	0.119 (3)	0.119 (3)			
	X ± 0.016 (± 0.4)	0.1 (2.54)	0.1 (2.54)	0.2 (5.08)	0.2 (5.08)			
	Ø ± 10%	0.02 (0.5)	0.02 (0.5)	0.02 (0.5)	0.024 (0.6)			
Temperature coefficient	0±30.10 ⁻⁶	-750.10 ⁻⁶	0±30.10 ⁻⁶	-750.10 ⁻⁶	0±30.10 ⁻⁶	-750.10 ⁻⁶	0±30.10 ⁻⁶	-750.10 ⁻⁶
Rated voltage (U _{RC})	25V	-	-	-	-	-	-	-
	50V	1pF to 680pF	1nF to 2.2nF	1nF to 1.5nF	2.2nF to 6.8nF	2.2nF to 3.3nF	3.3nF to 15nF	3.3nF to 6.8nF

Size	5A		5B		5C	
Dimensions Inches (mm)	L max	0.3 (7.6)	0.3 (7.6)	0.315 (8)		
	W max	0.217 (5.5)	0.217 (5.5)	0.276 (7)		
	T max	0.099 (2.5)	0.197 (5)	0.296 (7.5)		
	X ± 0.016 (± 0.4)	0.2 (5.08)	0.2 (5.08)	0.2 (5.08)		
	Ø ± 10%	0.024 (0.6)	0.024 (0.6)	0.024 (0.6)		
Temperature coefficient	0±30.10 ⁻⁶		0±30.10 ⁻⁶		0±30.10 ⁻⁶	
Rated voltage (U _{RC})	25V	-	-	-	47nF to 120nF	
	63V	4.7pF to 10nF		6.8nF to 47nF		-

Available capacitance values:

NP0: E6, E12, E24, E48, E96 (see page 14). Specific values upon request.

X7R: E6, E12, E24 (see page 14). Specific values upon request.

The above table defines the standard products, other components may be built upon request.

STANDARD

TCE / TCX / TCN / TXR Axial Series

Axial Molded Capacitors

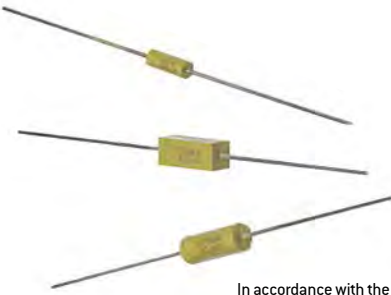

In accordance with the specifications of CECC 30600 and NF C 83131 standards

FEATURES

- Axial molded capacitors
- NPO, BX, 2C1, X7R dielectrics
- Capacitance range: 1pF to 6.8μF
- RoHS and Non RoHS compliant capacitors available

PHYSICAL CHARACTERISTICS

CONSTRUCTION

Leaded MLCC capacitors for through-hole mounting:
Epoxy molded capacitors

MARKING

Capacitance, tolerance, voltage, dielectric, date code.

ELECTRICAL SPECIFICATIONS

Description	NPO	BX	2C1	X7R
Dielectric code	CE	CX	CN	XR
Operating temperature	-55°C to +125°C			
Climatic category	55 / 125 / 56			
Rated voltage (U _{RC})	25V _{DC} to 500V _{DC}			
Max. ΔC/°C over temperature range without DC voltage applied	NA	±15%	±20%	±15%
Maximum ΔC/°C over temperature range with rated voltage applied	NA	+15% -25%	+20% -30%	NA
Temperature coefficient with or without DC voltage applied	(0±30)ppm/°C	NA	NA	NA
Dielectric withstanding voltage	2.5 U _{RC}			
Capacitance	at 1MHz for C ≤ 1,000pF at 1kHz for C > 1,000pF		at 1MHz for C ≤ 100pF at 1kHz for C > 100pF	
Dissipation factor at 25°C	≤ 0.015 (150/C + 7)% at 1MHz for C ≤ 50pF ≤ 0.15% at 1MHz for 50pF < C ≤ 1,000pF ≤ 0.15% at 1kHz for C > 1,000pF		≤ 2.5% at 1MHz for C ≤ 100pF ≤ 2.5% at 1kHz for C > 100pF	
Insulation resistance at 25°C	≥ 100,000 MΩ for C ≤ 10nF ≥ 1,000 MΩ.μF for C > 10nF			
Aging	None		≤ 2.5% per decade hour	

HOW TO ORDER

T	CE	52	W	F	3.3nF	10%	25V	B
Series	Dielectric	Size	RoHS compliant	Quality level	Capacitance	Tolerance	Rated voltage	Packaging
T = Axial leaded, molded capacitor	CE = NPO CX = BX CN = 2C1 XR = X7R	52 52R 53 53R 54 54R 55	- = No RoHS W = RoHS compliant	- = standard quality level F = Hi-Rel quality: screening in accordance with Exxelia specification	Capacitance value in clear	NPO: cap. value ≤ 12pF ±0.25pF cap. value ≤ 8.2pF ±0.5pF ±1pF cap. value > 22pF ±1% cap. value > 12pF ±2% cap. value > 8.2pF ±5% ±10% cap. value > 3.9pF ±20% <u>Available for BX, 2C1 and X7R:</u> ±5% ±10% ±20%	25V 50V 63V 100V 200V 250V 500V Intermediary and higher voltages available on request.	- = Exxelia packaging <u>Available for quantity</u> ≥ 500: B = reel

Axial Molded Capacitors

TCE / TCX / TCN / TXR Axial Series

DIMENSIONS in inches (mm)

Sizes 52R, 53R, 54R

Sizes 52, 53, 54

Size 55

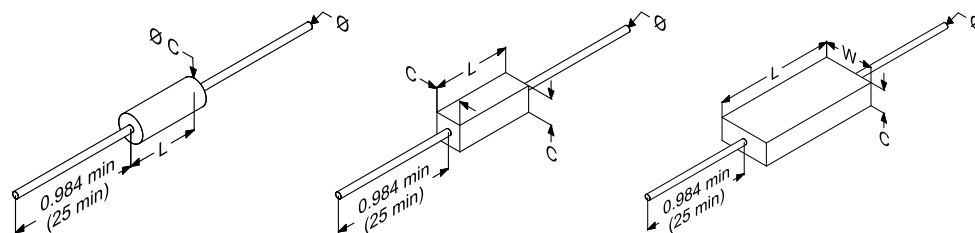

STANDARD RATINGS

Size	52				52R				53				53R				
Dimensions inches (mm)	L	0.217 max (5.5 max)				0.167 max (4.3 max)				0.296 max (7.5 max)				0.26 max (6.6 max)			
	C	0.099 max (2.5 max)				0.099 max (2.5 max)				0.099 max (2.5 max)				0.099 max (2.5 max)			
	W	-				-				-				-			
	Ø ± 10%	0.024 (0.6)				0.024 (0.6)				0.024 (0.6)				0.024 (0.6)			
Dielectric	NPO	BX	2C1	X7R	NPO	BX	2C1	X7R	NPO	BX	2C1	X7R	NPO	BX	2C1	X7R	
Dielectric code	CE	CX	CN	XR	CE	CX	CN	XR	CE	CX	CN	XR	CE	CX	CN	XR	
Min. Cap. value	1pF	10pF				10pF				1pF	10pF						
Rated voltage (U _{ric})	25V	3.3nF	82nF	100nF	120nF	10nF	220nF	220nF	220nF	10nF	220nF	220nF	220nF	10nF	220nF	220nF	
	50V	1.5nF	27nF	39nF	47nF	6.8nF	56nF	82nF	100nF	6.8nF	56nF	82nF	100nF	6.8nF	56nF	82nF	
	63V	1.2nF	15nF	22nF	33nF	6.8nF	33nF	47nF	68nF	6.8nF	33nF	47nF	68nF	6.8nF	33nF	47nF	
	100V	680pF	6.8nF	12nF	18nF	2.2nF	15nF	27nF	39nF	2.2nF	15nF	27nF	39nF	2.2nF	15nF	27nF	
	200V	180pF	1.5nF	2.7nF	4.7nF	560pF	2.7nF	4.7nF	8.2nF	560pF	2.7nF	4.7nF	8.2nF	560pF	2.7nF	4.7nF	
	250V	120pF	-	1.5nF	2.7nF	390pF	-	3.3nF	5.6nF	390pF	-	3.3nF	5.6nF	390pF	-	3.3nF	
	500V	39pF	-	-	-	120pF	-	-	-	120pF	-	-	-	120pF	-	-	

Size	54				54R				55			
Dimensions inches (mm)	L	0.394 max (10 max)				0.433 ± 0.02 (11 ± 0.5)						
	C	0.154 max (3.9 max)				0.217 ± 0.02 (5.5 ± 0.5)						
	W	-				0.315 ± 0.02 (8 ± 0.5)						
	Ø ± 10%	0.024 (0.6)				0.024 (0.6)						
Dielectric	NPO	BX	2C1	X7R	NPO	BX	2C1	X7R	NPO	BX	2C1	X7R
Dielectric code	CE	CX	CN	XR	CE	CX	CN	XR	CE	CX	CN	XR
Min. Cap. value	4.7pF	27pF				10pF	68pF					
Rated voltage (U _{ric})	25V	27nF	820nF	1µF	1µF	150nF	3.9µF	3.9µF	3.9µF	150nF	3.9µF	3.9µF
	50V	15nF	270nF	330nF	390nF	100nF	2.2µF	2.7µF	2.7µF	100nF	2.2µF	2.7µF
	63V	12nF	180nF	270nF	330nF	82nF	1.2µF	1.8µF	2.2µF	82nF	1.2µF	1.8µF
	100V	5.6nF	68nF	100nF	180nF	47nF	560nF	1µF	1.5µF	47nF	560nF	1µF
	200V	1.8nF	15nF	22nF	39nF	18nF	120nF	220nF	390nF	18nF	120nF	220nF
	250V	1.2nF	8.2nF	12nF	22nF	12nF	68nF	150nF	220nF	12nF	68nF	150nF
	500V	470pF	-	2.7nF	4.7nF	4.7nF	-	27nF	47nF	4.7nF	-	27nF

Available capacitance values:

NPO: E6, E12, E24, E48, E96 (see page 14). Specific values upon request.

X7R: E6, E12, E24 (see page 14). Specific values upon request.

The above table defines the standard products, other components may be built upon request.

STANDARD

TCE / TCX / TCN / TXR Conformal Coated Series

Radial Dipped Capacitors



In accordance with the specifications of CECC 30700 and NF C 83132 standards

FEATURES

- Radial conformal coated capacitors
- NPO, BX, 2C1, X7R dielectrics
- Capacitance range: 1pF to 6.8μF
- RoHS and Non RoHS compliant capacitors available

PHYSICAL CHARACTERISTICS

CONSTRUCTION

Leaded MLCC capacitors for through-hole mounting:
Epoxy molded capacitors

MARKING

Capacitance, tolerance, voltage, dielectric, date code.

ELECTRICAL SPECIFICATIONS

Description	NPO	BX	2C1	X7R
Dielectric code	CE	CX	CN	XR
Operating temperature	-55°C to +125°C			
Climatic category	55 / 125 / 56			
Rated voltage (U_{RC})	25V _{DC} to 500V _{DC}			
Max. ΔC/°C over temperature range without DC voltage applied	NA	±15%	±20%	±15%
Maximum ΔC/°C over temperature range with rated voltage applied	NA	+15% -25%	+20% -30%	NA
Temperature coefficient with or without DC voltage applied	(0±30)ppm/°C	NA	NA	NA
Dielectric withstanding voltage	2.5 U _{RC}			
Capacitance	at 1MHz for C ≤ 1,000pF at 1kHz for C > 1,000pF		at 1MHz for C ≤ 100pF at 1kHz for C > 100pF	
Dissipation factor at 25°C	≤ 0.015 (150/C + 7)% at 1MHz for C ≤ 50pF ≤ 0.15% at 1MHz for 50pF < C ≤ 1,000pF ≤ 0.15% at 1kHz for C > 1,000pF		≤ 2.5% at 1MHz for C ≤ 100pF ≤ 2.5% at 1kHz for C > 100pF	
Insulation resistance at 25°C	≥ 100,000 MΩ for C ≤ 10nF ≥ 1,000 MΩ.μF for C > 10nF			
Aging	None	≤ 2.5% per decade hour		

HOW TO ORDER

T	CE	77-1	W	F	2.7nF	10%	50V	B
Series	Dielectric	Size	RoHS compliant	Quality level	Capacitance	Tolerance	Rated voltage	Packaging
T = Radial leaded, conformal coated capacitor	CE = NPO CX = BX CN = 2C1 XR = X7R	77-1 77-5 78-1 78-5 79-5 80-5 76-5	- = No RoHS W = RoHS compliant	- = standard quality level F = Hi-Rel quality: screening in accordance with Exxelia specification	Capacitance value in clear	NPO: cap. value ≤ 12pF ±0.25pF cap. value ≤ 8.2pF ±0.5pF ±1pF cap. value > 22pF ±1% cap. value > 12pF ±2% cap. value > 8.2pF ±5% ±10% cap. value > 3.9pF ±20% Available for BX, 2C1 and X7R: ±5% ±10% ±20%	25V 50V 63V 100V 200V 250V 500V Intermediary and higher voltages available on request.	- = Exxelia packaging Available for quantity ≥ 500: B = reel

Radial Dipped Capacitors TCE / TCX / TCN / TXR Conformal Coated Series

DIMENSIONS in inches (mm)

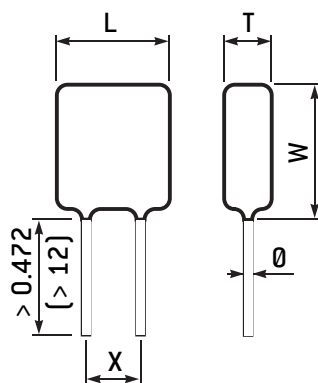

STANDARD RATINGS

Size	77-1				77-5				78-1		78-5					
Dimensions inches (mm)	L max.	0.150 (3.8)				0.150 (3.8)				0.197 (5)		0.197 (5)				
	W max.	0.229 (5.8)				0.209 (5.3)				0.276 (7)		0.256 (6.5)				
	T max.	0.099 (2.5)				0.099 (2.5)				0.123 (3.1)		0.123 (3.1)				
	X ± 0.008 (± 0.2)	0.2 (5.08)				0.1 (2.54)				0.2 (5.08)		0.1 (2.54)				
	0 ± 10%	0.024 (0.6)				0.024 (0.6)				0.024 (0.6)		0.024 (0.6)				
Dielectric	NPO		BX		2C1		X7R		NPO		BX		2C1		X7R	
Dielectric code	CE		CX		CN		XR		CE		CX		CN		XR	
Min. Cap. value	1pF		22pF				1pF		22pF							
Rated voltage (U _{rec})	25V	5.6nF	150nF	180nF	180nF	33nF	820nF	1µF	1µF							
	50V	2.7nF	39nF	56nF	82nF	15nF	220nF	390nF	470nF							
	63V	2.2nF	27nF	39nF	56nF	12nF	150nF	220nF	330nF							
	100V	1.2nF	10nF	18nF	33nF	6.8nF	56nF	120nF	180nF							
	200V	390pF	2.2nF	3.9nF	8.2nF	2.2nF	12nF	27nF	47nF							
	250V	220pF	1.2nF	2.8nF	4.7nF	1.2nF	8.2nF	18nF	33nF							
	500V	82pF	-	-	820pF	470pF	-	2.7nF	4.7nF							

Size	79-5				80-5				76-5									
Dimensions inches (mm)	L max.	0.299 (7.6)				0.398 (10.1)				0.5 (12.7)								
	W max.	0.378 (9.6)				0.477 (12.1)				0.56 (14.2)								
	T max.	0.15 (3.8)				0.15 (3.8)				0.197** (5)**								
	X ± 0.008 (± 0.2)	0.2 (5.08)				0.2 (5.08)				0.4* (10.16)*								
	0 ± 10%	0.024 (0.6)				0.024 (0.6)				0.024 (0.6)								
Dielectric	NPO		BX		2C1		X7R		NPO		BX		2C1		X7R			
Dielectric code	CE		CX		CN		XR		CE		CX		CN		XR			
Min. Cap. value	1nF		4.7nF				3.9nF		12nF				8.2nF		33nF			
Rated voltage (U _{rec})	25V	82nF	2.2µF	2.2µF	2.2µF	150nF	3.9µF	3.9µF	3.9µF	270nF	6.8µF	6.8µF	6.8µF					
	50V	56nF	1.2µF	1.5µF	1.5µF	100nF	2.7µF	2.7µF	2.7µF	180nF	4.7µF	4.7µF	4.7µF					
	63V	47nF	820nF	1µF	1.2µF	100nF	1.5µF	2.2µF	2.2µF	150nF	2.7µF	4.7µF	3.9µF					
	100V	27nF	270nF	560nF	820nF	56nF	560nF	1.2µF	1.2µF	100nF	1.2µF	2.2µF	2.2µF					
	200V	10nF	82nF	150nF	220nF	27nF	180nF	330nF	390nF	56nF	390nF	680nF	820nF					
	250V	6.8nF	47nF	100nF	150nF	15nF	100nF	220nF	220nF	39nF	270nF	470nF	560nF					
	500V	3.3nF	6.8nF	18nF	33nF	6.8nF	15nF	39nF	56nF	15nF	47nF	100nF	120nF					

* X = 0.2" (5.08mm) for Cr ≤ 1µF - 50V and Cr ≤ 680nF - 100V
 ** T max = 0.273" (6mm) for Cr ≥ 3.3µF - 50V

Available capacitance values:
 NPO: E6, E12, E24, E48, E96 (see page 14). Specific values upon request.
 X7R: E6, E12, E24 (see page 14). Specific values upon request.
 The above table defines the standard products, other components may be built upon request.

Non Magnetic Conformal Coated Series

Radial Dipped Capacitors



FEATURES

- Case sizes: 1812 to 2220
- NPO and X7R dielectrics
- Capacitance range: 180pF to 1µF
- RoHS compliant capacitors

PHYSICAL CHARACTERISTICS

MLCC capacitors with:

- Radial leads for through-hole mounting.

ELECTRICAL SPECIFICATIONS

Description	NPO dielectric	X7R dielectric
Dielectric code	N	X
CECC class	1B / CG	2R1
EIA class	Class I	Class II
Temperature range	-55°C to +125°C	-55°C to +125°C
Temperature coefficient	(0±30) ppm/°C	NA
Maximum ΔC/°C over temperature range without DC voltage applied	NA	±15%
Rated voltage (U _R)	100V _{DC} to 500V _{DC}	63V _{DC} to 500V _{DC}
Dielectric withstanding voltage	250% rated voltage	250% rated voltage
Insulation resistance (I _R) at 25°C under U _R	100GΩ or 1,000Ω.F whichever is less	100GΩ or 1,000Ω.F whichever is less
Aging	None	≤ 2.5% per decade hour

HOW TO ORDER

630	S43	X	394	K	R	E
Rated voltage	Exxelia size code	Dielectric code	Capacitance	Tolerance	Termination	Packaging
630 = 63V 101 = 100V 201 = 200V 501 = 500V	S43 = 1812 S47 = 2220	N = NPO X = X7R	Capacitance value in code. 1 st two digits represent significant figures; last digit specifies the number of zeros to follow. Examples: 101 = 100pF 472 = 4.7nF 683 = 68nF 564 = 0.56µF 105 = 1µF	NPO : F = ±1% G = ±2% J = ±5% K = ±10% M = ±20% X7R : K = ±10% M = ±20%	R = Radial two wires	- = Bulk E = tape & reel

Radial Dipped Capacitors

Non Magnetic Conformal Coated Series

DIMENSIONS in inches (mm)

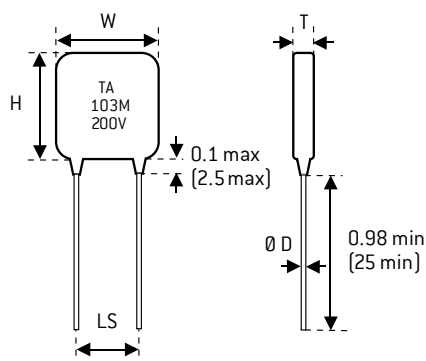

STANDARD RATINGS

Size		1812		2220	
Exxelia size code		S43		S47	
Dimensions inches (mm)	W	0.28 max. [7.1 max.]		0.327 max. [8.3 max.]	
	H	0.26 max. [6.6 max.]		0.335 max. [8.5 max.]	
	LS	0.2 ±0.02 [5.08 ±0.5]		0.2 ±0.02 [5.08 ±0.5]	
	Ø ±10%	0.024 [0.6]		0.024 [0.6]	
	T max.	0.146 [3.7]		0.146 [3.7]	
Dielectric		NPO	X7R	NPO	X7R
		N	X	N	X
Rated voltage (U _{rated})	63V	-	150nF to 1µF	-	330nF to 1µF
	100V	1.8nF to 5.6nF	-	6.8nF to 10nF	-
	200V	180pF to 5.6nF	2.7nF to 100nF	680pF to 10nF	6.8nF to 220nF
	500V	180pF to 2.2nF	2.7nF to 47nF	680pF to 4.7nF	6.8nF to 100nF

Available capacitance values:

E6, E12 (see page 14). Specific values upon request.

Note: some capacitance values in these tables may not be proposed for small quantities. Please, contact us for confirmation.

For exact values regarding the thickness, please consult us.

STANDARD

CK Series

Radial Molded Capacitors



In accordance with MIL C 11015 D standards

CKR 05/06 : on request, High reliability types.

FEATURES

- Radial molded capacitors
- BX dielectric
- Capacitance range: 10pF to 1μF
- RoHS and Non RoHS compliant capacitors available

PHYSICAL CHARACTERISTICS

CONSTRUCTION

Leaded MLCC capacitors for through-hole mounting:
Epoxy molded capacitors

MARKING

Capacitance, tolerance, voltage, dielectric, date code.

ELECTRICAL SPECIFICATIONS

Description	BX
Operating temperature	-55°C to +125°C
Climatic category	55 / 125 / 56
Rated voltage (U _{RC})	25V _{DC} to 250V _{DC}
Max. ΔC/°C over temperature range without DC voltage applied	±15%
Maximum ΔC/°C over temperature range with rated voltage applied	+15% -25%
Dielectric withstanding voltage	2.5 U _{RC}
Capacitance	at 1MHz for C ≤ 100pF at 1kHz for C > 100pF
Dissipation factor at 25°C	≤2.5% at 1MHz for C ≤ 100pF ≤2.5% at 1kHz for C > 100pF
Insulation resistance at 25°C	≥ 100,000 MΩ for C ≤ 10nF ≥ 1,000 MΩ.μF for C > 10nF
Aging	≤ 2.5% per decade hour

DIMENSIONS in inches [mm]

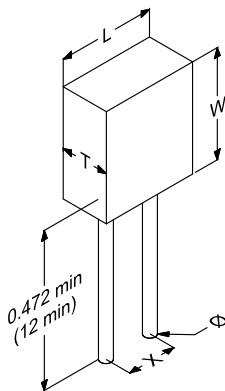

Available capacitance values:

BX: E6, E12, E24 (see page 14). Specific values upon request.

The above table defines the standard products, other components may be built upon request.

STANDARD RATINGS

Size	05	06	
Dimensions inches [mm]	L	0.189 ± 0.008 (4.8 ± 0.2)	0.291 ± 0.008 (7.4 ± 0.2)
	W	0.189 ± 0.008 (4.8 ± 0.2)	0.291 ± 0.008 (7.4 ± 0.2)
	T	0.091 ± 0.008 (2.3 ± 0.2)	0.091 ± 0.008 (2.3 ± 0.2)
	X	0.2 ± 0.008 (5.08 ± 0.2)	0.2 ± 0.008 (5.08 ± 0.2)
	0 ± 10%	0.024 (0.6)	0.024 (0.6)
Min. Cap. value	10pF	1.2 nF	
Rated voltage [U _{RC}]	50V	100nF	1μF
	100V	10nF	100nF
	200V	1nF	10nF

HOW TO ORDER

CK	05	W	F	820nF	10%	25V	B	-
Series	Size	RoHS compliant	Quality level	Capacitance	Tolerance	Rated voltage	Packaging	Reliability level
CK = Radial leaded, molded capacitor	05 06	- = No RoHS W = RoHS compliant	- = standard quality level F = Hi-Rel quality: screening in accordance with Exxelia specification	Capacitance value in clear	±10% ±20%	25V 100V 50V 200V 63V 250V Intermediary and higher voltages available on request	- = Exxelia packaging Available for quantity ≥ 500: B = reel	For F parts only, Acc. to Exxelia spec. - T5 T6 See page 15

HIGH VOLTAGE

GENERAL INFORMATION 46

C SERIES
High Voltage Chips Capacitors 51

TCF SERIES
High Voltage Conformal Coated Leaded Caps 54

TKD SERIES
High Voltage Conformal Coated Leaded Caps 57

TCL SERIES
High Voltage Molded & Varnished Leaded Caps 59

TCK SERIES
High Voltage Conformal Coated Leaded Caps 62

CF/CFS SERIES
High Voltage Conformal Coated Leaded Caps 65

CS SERIES
High Voltage Stacked Capacitors 70



General Information

High voltage multilayer ceramic capacitors designed by EXXELIA are adapted to applications in electronics such as high voltage power supplies and high circuits. Their multilayer construction offers significant size and space saving advantages. They are available in class 1 (NPO), class 2 (X7R) and C4xx (-2,200 ppm/°C) dielectrics versions complying with the main requirements of applicable standards. They are suited for use in commercial, industrial and High-Rel military and space circuits.

As standard products can't meet all the specificities of all applications, special applications may require specific features (higher voltage, burn-in, dimensions, coating, leading, marking...) not described in this catalogue. Based on our state-of-the-art technologies and our expertise, our Engineers may study at your request all special components to meet your application.

Please, consult us for more information.

NPO, X7R, C4xx: SELF-RESONANCE FREQUENCY VS CAPACITANCE

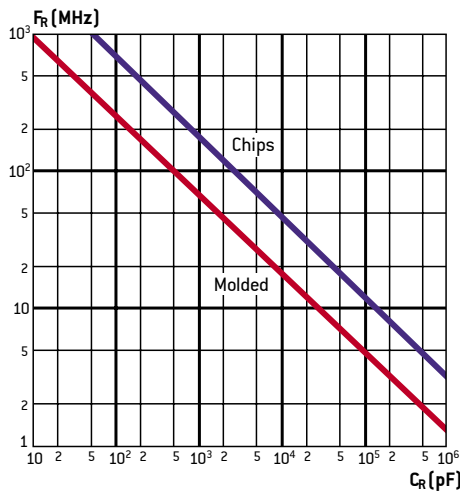

NPO/COG DIELECTRICS (CLASS 1)

Made of titanium oxide and other various selected oxides, they feature unique stability of all parameters under such constraints as operating time, temperature, voltage applied. For example, the quality factor remains very high over an extremely wide frequency range. As example, loss angle tangent value at 1MHz is typically in the order of 3.10⁻⁴. These characteristics make them compatible with steep-edge impulse mode without noticeable temperature rise. The different parameters and related variations are illustrated in figures below:

NPO: RELATIVE CAPACITANCE CHANGE VS TEMPERATURE

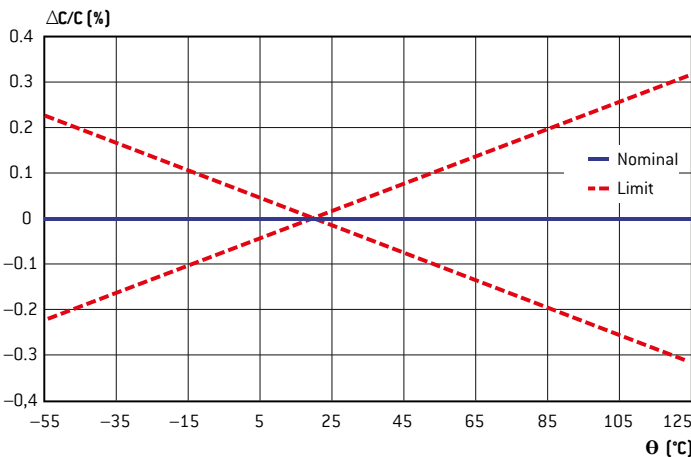

NPO: IMPEDANCE VS FREQUENCY

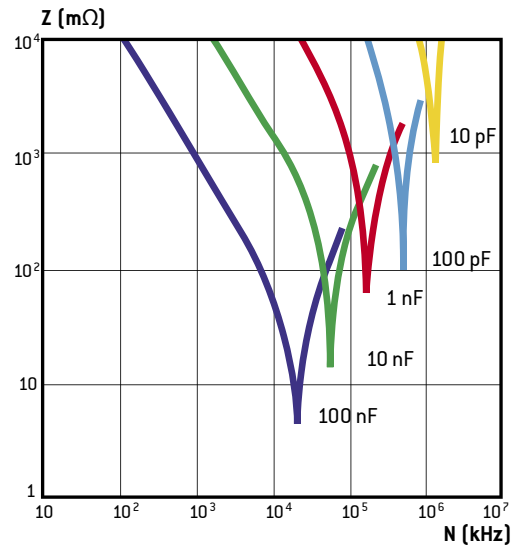

NPO: LOSS TANGENT VS TEMPERATURE

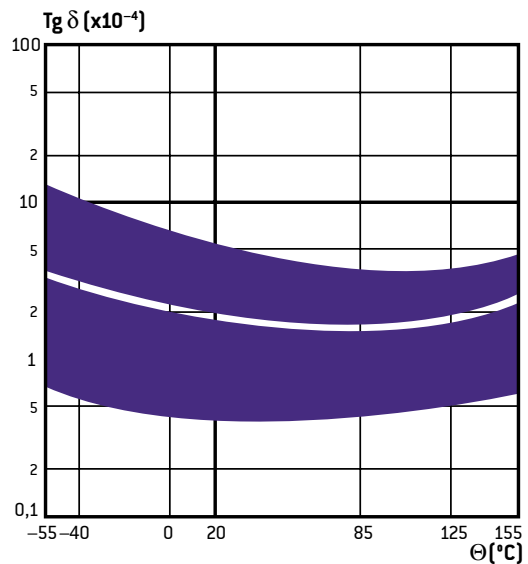

NPO: INSULATION RESISTANCE VS TEMPERATURE

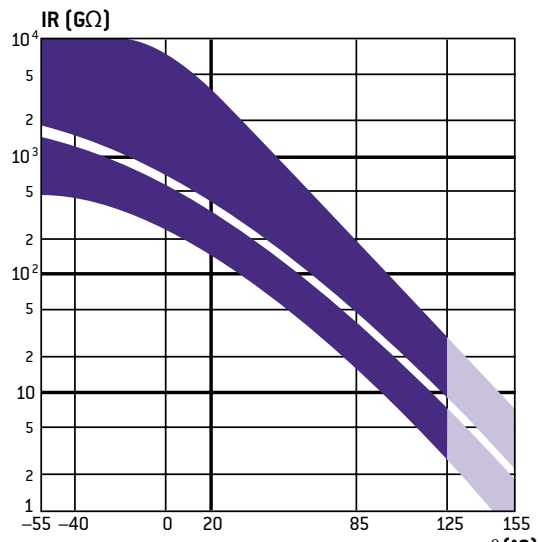

General Information

X7R DIELECTRICS (CLASS 2)

They are mainly made of barium titanate modified by various oxides to achieve the electrical properties required. A specific ceramic dielectric is used to achieve an excellent dielectric strength. High dielectric constant enables to achieve high capacitance values.

For optimum use, the specific properties of barium titanate in function of the different parameters must be taken into account.

See the variations illustrated in figures below:

CHANGE VS PERCENTAGE OF RATED VOLTAGE APPLIED

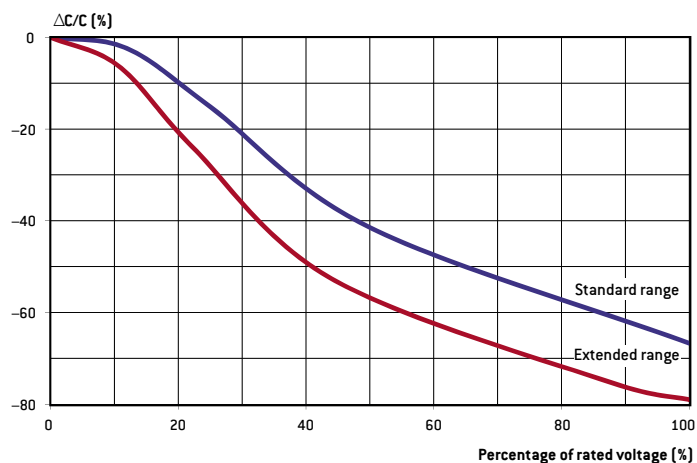

X7R: CAPACITANCE CHANGE VS TEMPERATURE

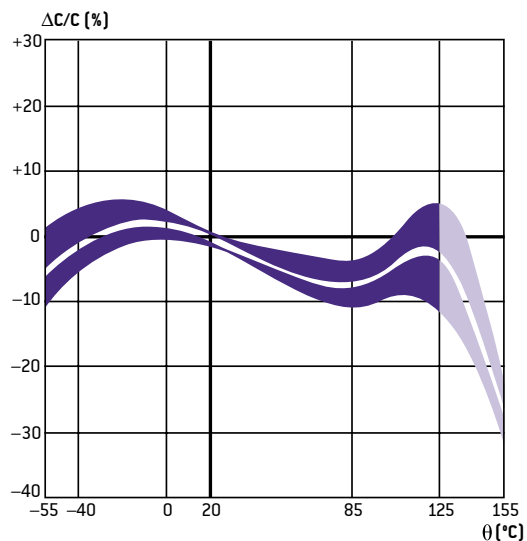

X7R: CAPACITANCE CHANGE VS FREQUENCY

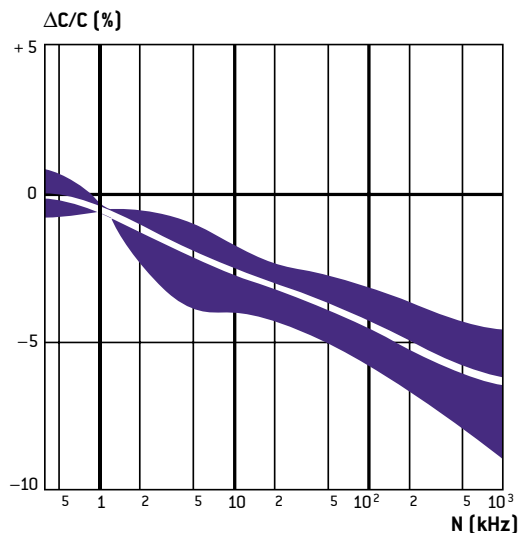

X7R: INSULATION RESISTANCE VS TEMPERATURE

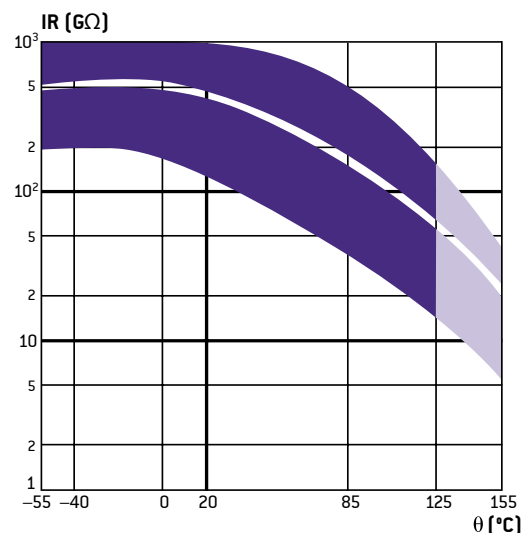

HIGH VOLTAGE

General Information

X7R: LOSS TANGENT CHANGE VS TEMPERATURE

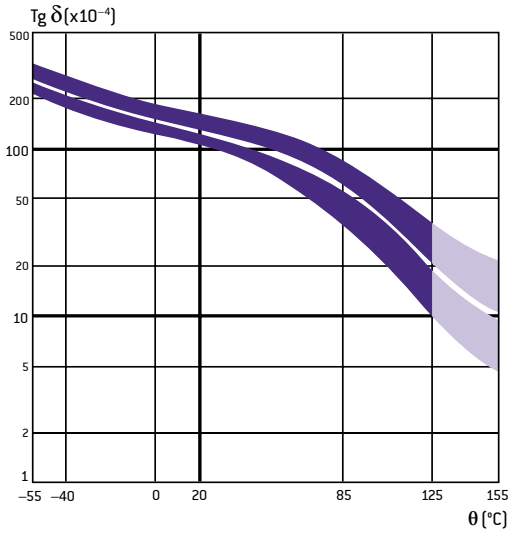

X7R: MAXIMUM ADMISSIBLE CURRENT VS FREQUENCY

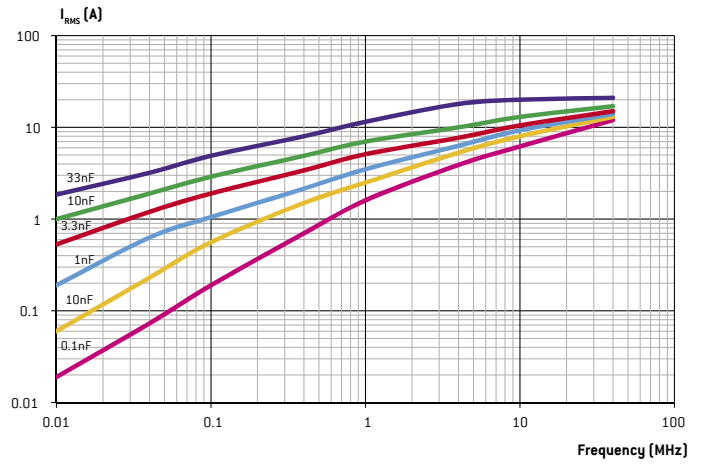

These typical curves are examples of admissible currents for one family of chip capacitors (size 3333). For other curves and products or for further information, please contact us.

Note: for the calculations, we have considered that the terminations are directly connected to an infinite heat sink. In other words, the thermal resistance of the circuit itself which depends on its type and design has not been taken into account. Moreover, the ambient temperature taken is 25°C.

X7R: LOSS TANGENT CHANGE VS FREQUENCY

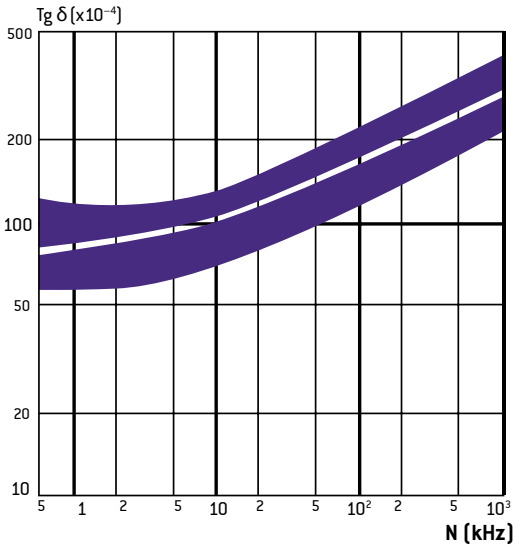

X7R: ESR VS FREQUENCY

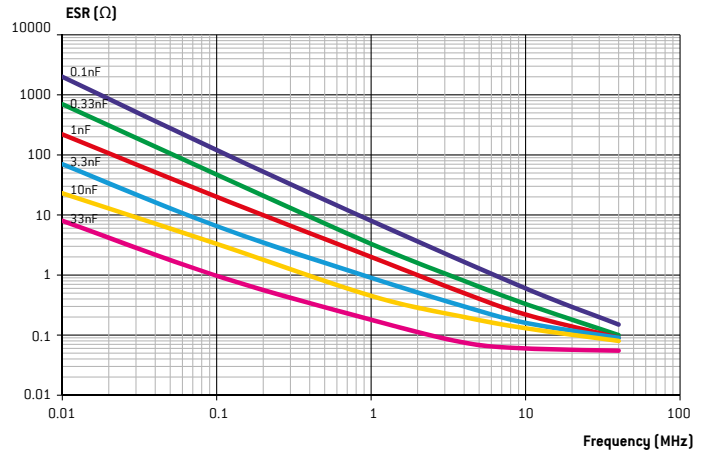

The ESR (Equivalent Serial Resistance) typical curves are given, here for SMD (chip) capacitors. Regarding the curves for the leaded capacitors, they are rather the same. Indeed, due to the resistivity of the raw material used and the wire diameters, the resistance of the wires is much lower than the ESR of the chips. So, in a first approach, their influence can be considered as negligible.

General Information

C4xx DIELECTRIC

This ceramic is a negative temperature coefficient dielectric [-2,200 ppm/°C]. Its advantage is that it combines the high dielectric constant of an X7R dielectric with the stability of an NPO dielectric. As the C4xx ceramic features low dissipation factor it is recommended for AC line filtering from 110 Vrms to 230 Vrms, 20 to 400 Hz, for high power RF at high voltage up to 5,000 V and for pulse applications.

C4xx: TEMPERATURE COEFFICIENT

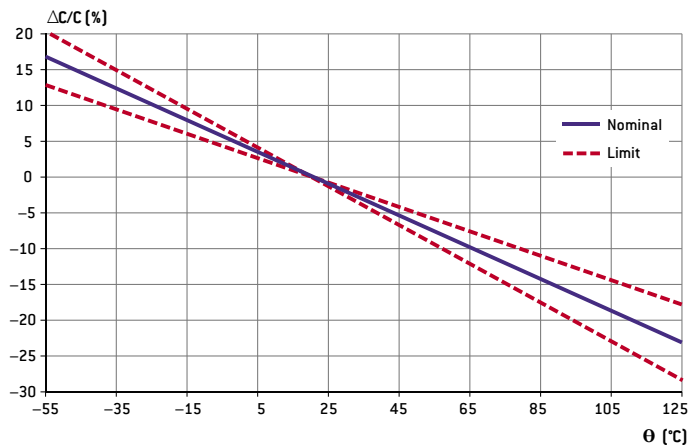

C4xx: VOLTAGE COEFFICIENT

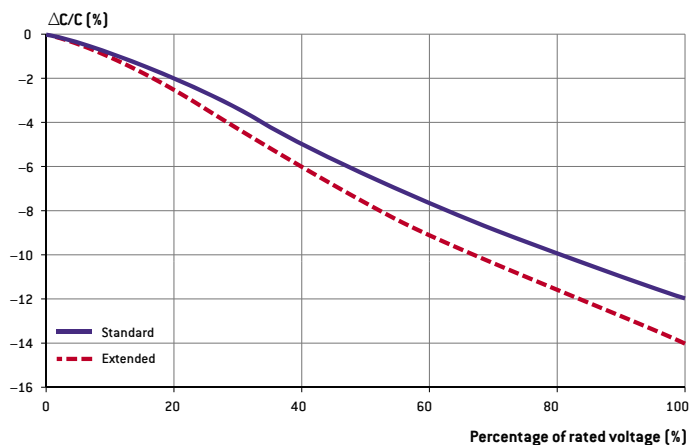

COMPARISON OF CAPACITANCE VALUE UNDER RATED VOLTAGE AT 125°C

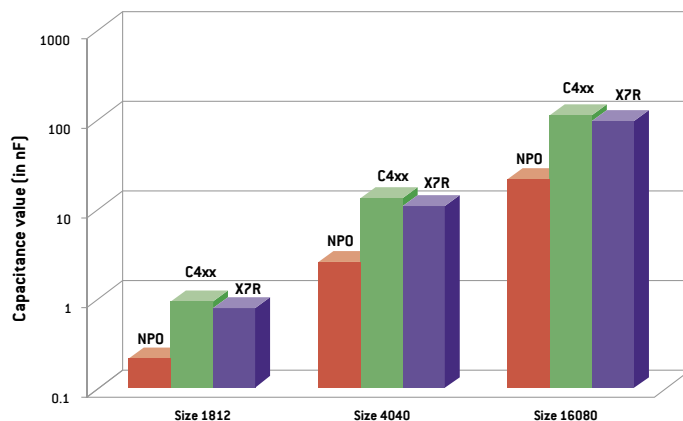

HIGH VOLTAGE

COMPARISON OF SELF-HEATING AT 400 Hz BETWEEN C4xx AND X7R DIELECTRICS

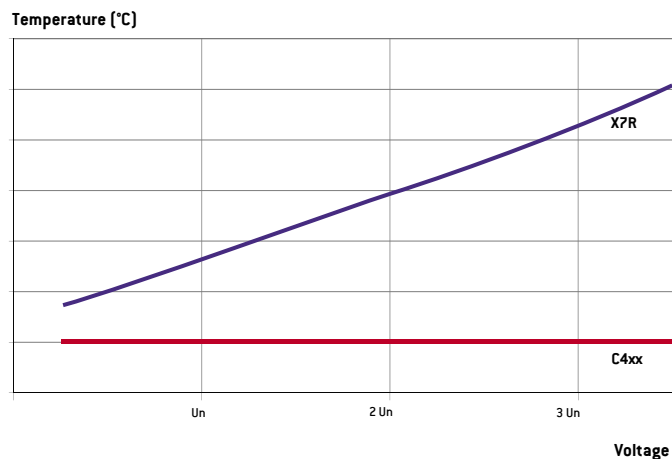

General Information

RECOMMENDED FOOTPRINTS

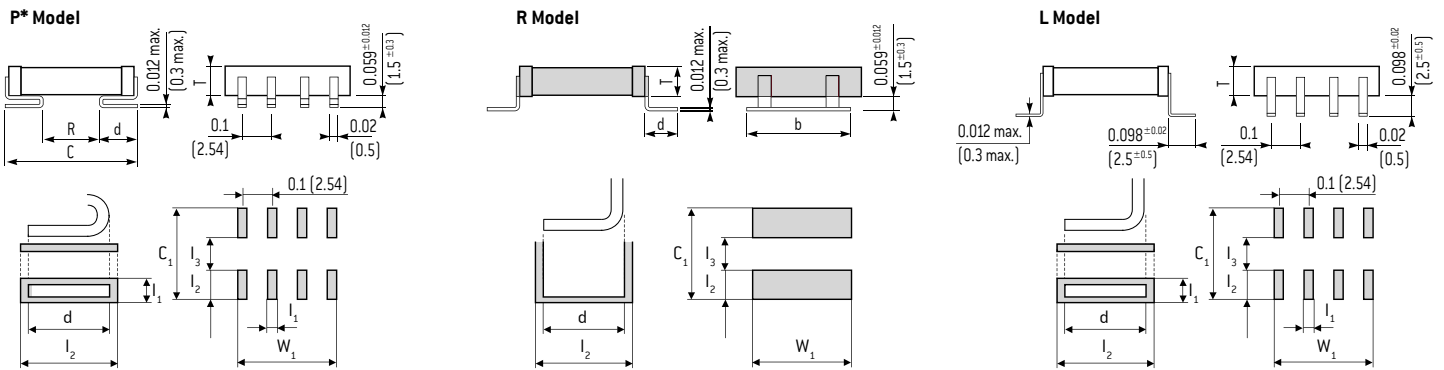

DIMENSIONS in inches (mm)

Exxelia size code	Lead shape	C max inches (mm)	Leads per side	d inches (mm)	b inches (mm)	C ₁ inches (mm)	W ₁ inches (mm)	I ₁ inches (mm)	I ₂ inches (mm)	I ₃ inches (mm)
90	P*	0.228 (5.8)	2	0.06 ± 0.012 (1.5 ± 0.3)	-	0.268 (6.8)	0.147 (3.74)	0.047 (1.2)	0.108 (2.75)	0.098 (2.5)
	L	0.394 (10)	2	0.098 ± 0.02 (2.5 ± 0.5)	-	0.433 (11)	0.147 (3.74)	0.047 (1.2)	0.152 (3.85)	0.130 (3.3)
	R	0.386 (9.8)	1	0.087 ± 0.008 (2.2 ± 0.2)	0.197 ± 0.02 (5 ± 0.5)	0.425 (10.8)	0.244 (6.2)	-	0.148 (3.75)	0.130 (3.3)
80	P*	0.276 (7)	2	0.06 ± 0.012 (1.5 ± 0.3)	-	0.315 (8)	0.147 (3.74)	0.047 (1.2)	0.108 (2.75)	0.098 (2.5)
	L	0.480 (12.2)	2	0.098 ± 0.02 (2.5 ± 0.5)	-	0.520 (13.2)	0.147 (3.74)	0.047 (1.2)	0.171 (4.35)	0.177 (4.5)
	R	0.433 (11)	1	0.087 ± 0.008 (2.2 ± 0.2)	0.197 ± 0.02 (5 ± 0.5)	0.472 (12)	0.244 (6.2)	-	0.148 (3.75)	0.177 (4.5)
91	P*	0.276 (7)	2	0.06 ± 0.012 (1.5 ± 0.3)	-	0.315 (8)	0.147 (3.74)	0.047 (1.2)	0.108 (2.75)	0.098 (2.5)
	L	0.480 (12.2)	2	0.098 ± 0.02 (2.5 ± 0.5)	-	0.520 (13.2)	0.147 (3.74)	0.047 (1.2)	0.171 (4.35)	0.177 (4.5)
	R	0.433 (11)	1	0.087 ± 0.008 (2.2 ± 0.2)	0.197 ± 0.02 (5 ± 0.5)	0.472 (12)	0.244 (6.2)	-	0.148 (3.75)	0.177 (4.5)
81	P*	0.315 (8)	2	0.087 ± 0.012 (2.2 ± 0.3)	-	0.354 (9)	0.147 (3.74)	0.047 (1.2)	0.108 (2.75)	0.138 (3.5)
	L	0.531 (13.5)	2	0.098 ± 0.02 (2.5 ± 0.5)	-	0.571 (14.5)	0.147 (3.74)	0.047 (1.2)	0.171 (4.35)	0.228 (5.8)
	R	0.484 (12.3)	1	0.087 ± 0.008 (2.2 ± 0.2)	0.197 ± 0.02 (5 ± 0.5)	0.524 (13.3)	0.244 (6.2)	-	0.148 (3.75)	0.228 (5.8)
82	P*	0.354 (9)	3	0.087 ± 0.012 (2.2 ± 0.3)	-	0.394 (10)	0.247 (6.28)	0.047 (1.2)	0.108 (2.75)	0.177 (4.5)
	L	0.587 (14.9)	3	0.098 ± 0.02 (2.5 ± 0.5)	-	0.626 (15.9)	0.247 (6.28)	0.047 (1.2)	0.171 (4.35)	0.283 (7.2)
	R	0.642 (16.3)	1	0.138 ± 0.008 (3.5 ± 0.2)	0.315 ± 0.02 (8 ± 0.5)	0.681 (17.3)	0.362 (9.2)	-	0.199 (5.05)	0.283 (7.2)
83	P*	0.472 (12)	4	0.087 ± 0.012 (2.2 ± 0.3)	-	0.512 (13)	0.347 (8.82)	0.047 (1.2)	0.118 (3)	0.276 (7)
	L	0.676 (17.16)	4	0.098 ± 0.02 (2.5 ± 0.5)	-	0.715 (18.16)	0.347 (8.82)	0.047 (1.2)	0.191 (4.85)	0.333 (8.46)
	R	0.731 (18.56)	1	0.138 ± 0.008 (3.5 ± 0.2)	0.315 ± 0.02 (8 ± 0.5)	0.770 (19.56)	0.362 (9.2)	-	0.219 (5.55)	0.333 (8.46)
84	P*	0.610 (15.5)	4	0.087 ± 0.012 (2.2 ± 0.3)	-	0.650 (16.5)	0.347 (8.82)	0.047 (1.2)	0.128 (3.25)	0.394 (10)
	L	0.815 (20.7)	4	0.098 ± 0.02 (2.5 ± 0.5)	-	0.854 (21.7)	0.347 (8.82)	0.047 (1.2)	0.191 (4.85)	0.472 (12)
	R	0.870 (22.1)	1	0.138 ± 0.008 (3.5 ± 0.2)	0.315 ± 0.02 (8 ± 0.5)	0.909 (23.1)	0.362 (9.2)	-	0.219 (5.55)	0.472 (12)
89	P*	0.630 (16)	5	0.087 ± 0.012 (2.2 ± 0.3)	-	0.669 (17)	0.347 (8.82)	0.047 (1.2)	0.128 (3.25)	0.413 (10.5)
	L	0.827 (21)	5	0.098 ± 0.02 (2.5 ± 0.5)	-	0.866 (22)	0.347 (8.82)	0.047 (1.2)	0.191 (4.85)	0.484 (12.3)
	R	0.882 (22.4)	1	0.138 ± 0.008 (3.5 ± 0.2)	0.315 ± 0.02 (8 ± 0.5)	0.921 (23.4)	0.362 (9.2)	-	0.219 (5.55)	0.484 (12.3)
85	P*	0.728 (18.5)	6	0.087 ± 0.012 (2.2 ± 0.3)	-	0.768 (19.5)	0.547 (13.9)	0.047 (1.2)	0.128 (3.25)	0.512 (13)
	L	0.925 (23.5)	6	0.098 ± 0.02 (2.5 ± 0.5)	-	0.965 (24.5)	0.547 (13.9)	0.047 (1.2)	0.191 (4.85)	0.583 (14.8)
	R	0.980 (24.9)	1	0.138 ± 0.008 (3.5 ± 0.2)	0.591 ± 0.02 (15 ± 0.5)	1.020 (25.9)	0.638 (16.2)	-	0.219 (5.55)	0.583 (14.8)
87	P*	1.260 (32)	6	0.087 ± 0.012 (2.2 ± 0.3)	-	1.299 (33)	0.547 (13.9)	0.047 (1.2)	0.128 (3.25)	0.945 (24)
	L	1.398 (35.5)	6	0.098 ± 0.02 (2.5 ± 0.5)	-	1.437 (36.5)	0.547 (13.9)	0.047 (1.2)	0.191 (4.85)	1.055 (26.8)
	R	1.453 (36.9)	1	0.138 ± 0.008 (3.5 ± 0.2)	0.591 ± 0.02 (15 ± 0.5)	1.492 (37.9)	0.638 (16.2)	-	0.219 (5.55)	1.055 (26.8)
88	P*	1.654 (42)	6	0.087 ± 0.012 (2.2 ± 0.3)	-	1.693 (43)	0.547 (13.9)	0.047 (1.2)	0.128 (3.25)	1.378 (35)
	L	1.831 (46.5)	6	0.098 ± 0.02 (2.5 ± 0.5)	-	1.870 (47.5)	0.547 (13.9)	0.047 (1.2)	0.191 (4.85)	1.488 (37.8)
	R	1.886 (47.9)	1	0.138 ± 0.008 (3.5 ± 0.2)	0.591 ± 0.02 (15 ± 0.5)	1.925 (48.9)	0.638 (16.2)	-	0.219 (5.55)	1.488 (37.8)

* For PL and PLS, add 0.098 in (2.5 mm) to d and I2 and 0.197 in (5 mm) to C1.

High Voltage Chips Capacitors

C Series

According to
Available space ranges:
consult our detail
specifications



FEATURES

- Multilayer chip ceramic capacitors
- Size 1515 to 16080
- NPO, C4xx and X7R dielectrics
- Capacitance range: 10pf to 39 μ F
- Voltage range: 200 V_{DC} to 10,000 V_{DC}

PHYSICAL CHARACTERISTICS

CONSTRUCTION

- C Series: Unleaded chip capacitors for surface mounting with optional tinning.
- P, PL, L models: DIL leaded uncoated chip capacitors for surface mounting recommended to eliminate thermomechanical stresses.
- N, NU models: DIL leaded chip capacitors for through-hole circuits (N: varnished chips, NU: uncoated chips).
- R, RU models: Ribbon leaded chip capacitors for surface mounting (R: varnished chips, RU: uncoated chips) recommended to eliminate thermomechanical stresses.

MARKING (On request on unleaded chips)

Series, capacitance value, tolerance, rated voltage clear or coded, date code.

ELECTRICAL SPECIFICATIONS

Dielectric	NPO	C4xx	X7R
Dielectric code	1	4	2
Maximum ΔC/°C over temperature range without voltage	NA	NA	$\pm 15\%$
Temperature coefficient	$[0 \pm 30]$ ppm/°C	$[-2,200 \pm 500]$ ppm/°C	NA
Aging	None	None	$\leq 2.5\%$ per decade hour
Operating temperature	-55°C to $+125^\circ\text{C}$		
Rated voltage (U_{RC})	200 V _{DC} to 10,000 V _{DC}	200 V _{DC} to 5,000 V _{DC}	200 V _{DC} to 10,000 V _{DC}
Dielectric withstanding voltage	2.5 U _{RC} for U _{RC} \leq 500 V _{DC} 1.6 U _{RC} for U _{RC} \geq 1,000 V _{DC} Extended range: 2 U _{RC} for U _{RC} \leq 500 V _{DC} 1.3 U _{RC} for U _{RC} \geq 1,000 V _{DC}	2.5 U _{RC} for = 200 V _{DC} 2 U _{RC} for U _{RC} = 500 V _{DC} 1.5 U _{RC} for U _{RC} = 1,000 V _{DC} 1.4 U _{RC} for U _{RC} > 1,000 V _{DC} Extended range: 1.5 U _{RC} for U _{RC} \leq 500 V _{DC} 1.2 U _{RC} for U _{RC} \geq 1,000 V _{DC}	2.5 U _{RC} for U _{RC} = 200 V _{DC} 2 U _{RC} for U _{RC} = 500 V _{DC} 1.5 U _{RC} for U _{RC} = 1,000 V _{DC} 1.2 U _{RC} for U _{RC} > 1,000 V _{DC} Extended range: 1.5 U _{RC} for U _{RC} \leq 500 V _{DC} 1.2 U _{RC} for U _{RC} \geq 1,000 V _{DC}
Capacitance	at 1MHz for C \leq 1,000pf at 1kHz for C > 1,000pf	at 1kHz	at 1kHz
	$\leq 0.015 (150/C + 7)\%$ at 1MHz for C \leq 50pf		
Dissipation factor	$\leq 0.15\%$ at 1MHz for 50pf < C \leq 1,000pf $\leq 0.15\%$ at 1kHz for C > 1,000pf	$\leq 0.10\%$ at 1kHz	$\leq 2.5\%$ at 1kHz
Insulation resistance at 25°C under U_{RC} for U_{RC} \leq 500V_{DC} under 500V_{DC} for U_{RC} > 500V_{DC}	$\geq 100,000 \text{ M}\Omega$ for C \leq 10nf $\geq 1,000 \text{ M}\Omega \cdot \mu\text{F}$ for C > 10nf	$\geq 20,000 \text{ M}\Omega$ for C \leq 25nf $\geq 500 \text{ M}\Omega \cdot \mu\text{F}$ for C > 25nf	

HIGH VOLTAGE

C	2	80	C	P	M	F	1 μ F	10%	200V	S12	T5
Series	Dielectric	Exxelia size code	Termination (Bare chips only)	Leads style + finishing (Leaded chips only)	Marking	Quality level	Capacitance	Tolerance	Rated voltage	Packaging	Reliability level
C = High voltage chip capacitor	1 = NPO 2 = X7R 4 = C4xx	78 = 1515	W = RoHS compliant For all sizes - Ag/Pd/Pt W Ag/Pd/Pt Q wAg QW Ag From 1812 to 3333 sizes - Ag/Pd/Pt W Ag/Pd/Pt H Ag/Pd/Pt + dipped Sn/Pb 60/40 HW Ag/Pd/Pt + dipped Sn E Ni* + dipped Sn/Pb 60/40 C Ni** + electrolytic Sn/Pb 95/5 CW Ni + electrolytic Sn D Ag + Ni*** + electrolytic Sn/Pb 60/40 G Ni + electrolytic Gold From 1812 to 4040 sizes YC Ag + Polymer + Ni + Sn/Pb 95/5 YCW Ag + Polymer + Ni + Sn YD Ag + Polymer + Ni + Sn/Pb 60/40 YG Ag + Polymer + Ni + Au YGW Ag + Polymer + Ni + Au * Only 2225 to 16080 sizes ** Only 1515 to 2220 sizes (other sizes on demand) *** Only 1515 (other sizes on demand)	P PW - RoHS PL PLW - RoHS L LW - RoHS R RW - RoHS RU RUW - RoHS N NW - RoHS NU NUW - RoHS not available for sizes 1515 and 1812	Only for unleaded chips [Leaded chips are always marked]. - = no marking M = Marking: For sizes 1515 - 1825: Cap. value. For other sizes: EFD, Series, cap. value, tolerance, rated voltage, date code.	- = standard quality level F = Hi-Rel quality: screening in accordance with Exxelia specification	Capacitance value in clear	For NPO dielectric: $\pm 1\%$ $\pm 2\%$ $\pm 5\%$ $\pm 10\%$ $\pm 20\%$ For C4xx dielectric: $\pm 2\%$ $\pm 5\%$ $\pm 10\%$ $\pm 20\%$ For X7R dielectric: $\pm 10\%$ $\pm 20\%$	200V 500V 1,000V 1,500V 2,000V 3,000V 4,000V 5,000V 7,500V 10,000V Intermediary and higher voltages available on request.	- = Exxelia packaging (leaded chips: thermoformed packaging) Only available for unleaded chips: S12 = Super 12 reel Sizes 1515 - 2220: BA = Tray package (non oriented chips) BA0 = Tray package (oriented chips) See page 13	For F parts only. Acc. to Exxelia spec. - T5 T6 See page 15

C Series

High Voltage Chips Capacitors

DIMENSIONS in inches (mm)

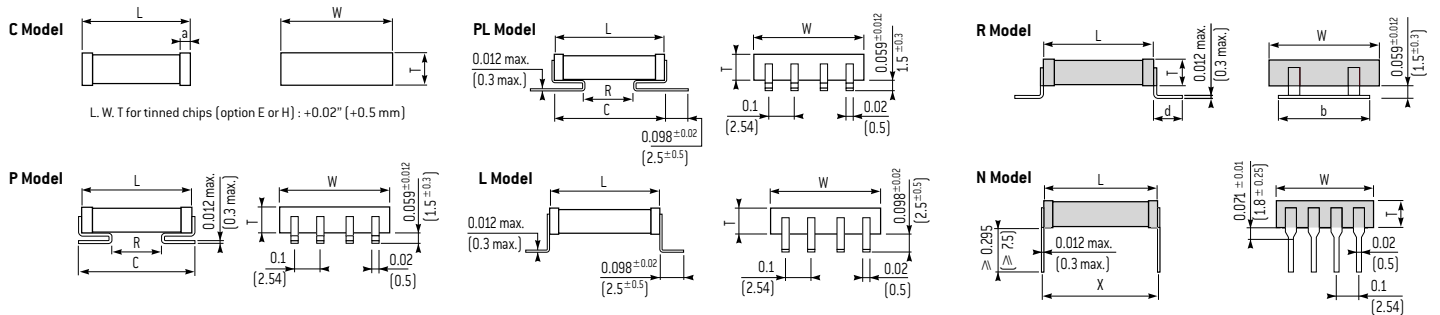

STANDARD RATINGS

	Size	1515	1812	1825	2220	2225	2825	3333														
	Exxelia size code	78	79	90	80	91	81	82														
Dimensions inches (mm)	L*	0.15 ± 0.015 (3.8 ± 0.38)	0.177 ± 0.020 (4.5 ± 0.5)	0.177 ± 0.020 (4.5 ± 0.5)	0.224 ± 0.020 (5.7 ± 0.5)	0.224 ± 0.020 (5.7 ± 0.5)	0.276 ± 0.020 (7 ± 0.5)	0.331 ± 0.020 (8.4 ± 0.5)														
	W*	0.15 ± 0.015 (3.8 ± 0.38)	0.126 ± 0.020 (3.2 ± 0.5)	0.250 ± 0.020 (6.35 ± 0.5)	0.197 ± 0.020 (5.0 ± 0.5)	0.250 ± 0.020 (6.35 ± 0.5)	0.250 ± 0.020 (6.35 ± 0.5)	0.331 ± 0.020 (8.4 ± 0.5)														
	a	0.012 min (0.3 min)	0.024 ± 0.020 (0.6 ± 0.5)	0.024 ± 0.020 (0.6 ± 0.5)	0.028 ± 0.020 (0.7 ± 0.5)	0.028 ± 0.020 (0.7 ± 0.5)	0.039 ± 0.020 (1 ± 0.5)	0.039 ± 0.020 (1 ± 0.5)														
	d	-	-	0.087 ± 0.008 (2.2 ± 0.2)	0.087 ± 0.008 (2.2 ± 0.2)	0.087 ± 0.008 (2.2 ± 0.2)	0.087 ± 0.008 (2.2 ± 0.2)	0.138 ± 0.008 (3.5 ± 0.2)														
	b	-	-	0.197 ± 0.020 (5 ± 0.5)	0.197 ± 0.020 (5 ± 0.5)	0.197 ± 0.020 (5 ± 0.5)	0.197 ± 0.020 (5 ± 0.5)	0.315 ± 0.020 (8 ± 0.5)														
	R min.	-	-	0.066 (1.7)	0.098 (2.5)	0.098 (2.5)	0.137 (3.5)	0.177 (4.5)														
	C max.	-	-	0.229 (5.8)	0.276 (7)	0.276 (7)	0.315 (8)	0.355 (9)														
	X	-	-	0.2 ± 0.020 (5.08 ± 0.5)	0.248 ± 0.020 (6.3 ± 0.5)	0.248 ± 0.020 (6.3 ± 0.5)	0.300 ± 0.020 (7.62 ± 0.5)	0.350 ± 0.020 (8.9 ± 0.5)														
	Leads per side	-	-	2	2	2	2	3														
	T max.*	0.154 (3.9)	0.138 (3.5)	0.138 (3.5)	0.2kV up to 3kV: 0.119 [3] 4kV-5kV: 0.150 [3.8]	0.2kV up to 3kV: 0.158 [4] 4kV-5kV: 0.197 [5]	0.2kV up to 3kV: 0.158 [4] 4kV: 0.197 [5] 5kV: 0.237 [6]	0.2kV up to 3kV: 0.158 [4] 4kV: 0.197 [5] 5kV: 0.237 [6]														
Dielectric	NPO	X7R	NPO	C4xx	X7R	NPO	C4xx	X7R	NPO	C4xx	X7R	NPO	C4xx	X7R	NPO	C4xx	X7R	NPO	C4xx	X7R		
Exxelia ceramic code	1	2	1	4	2	1	4	2	1	4	2	1	4	2	1	4	2	1	4	2		
Min. Capacitance value	12pF	120pF	10pF	27pF	100pF	10pF	33pF	150pF	10pF	33pF	150pF	15pF	47pF	150pF	18pF	56pF	150pF	33pF	82pF	330pF		
Rated voltage (U _{RC})	0.2kV	Standard	-	-	5.6nF	120nF	220nF	12nF	220nF	470nF	12nF	220nF	390nF	15nF	330nF	560nF	18nF	390nF	820nF	33nF	680nF	1.5µF
		Extended	-	-	18nF	-	470nF	27nF	-	-	22nF	-	1µF	39nF	-	-	56nF	-	1.8µF	100nF	-	2.7µF
	0.5kV	Standard	-	-	3.3nF	22nF	47nF	6.8nF	47nF	100nF	5.6nF	47nF	100nF	6.8nF	68nF	150nF	8.2nF	82nF	220nF	22nF	120nF	390nF
		Extended	-	-	10nF	39nF	150nF	18nF	68nF	-	18nF	68nF	270nF	22nF	100nF	-	27nF	120nF	560nF	68nF	220nF	1µF
	1kV	Standard	-	-	1.8nF	6.8nF	15nF	2.7nF	12nF	22nF	2.2nF	12nF	22nF	3.3nF	18nF	33nF	3.9nF	22nF	47nF	10nF	39nF	68nF
		Extended	820pF	12nF	5.6nF	10nF	27nF	8.2nF	15nF	-	6.8nF	15nF	56nF	10nF	22nF	-	12nF	27nF	120nF	33nF	56nF	220nF
	1.5kV	Standard	-	-	820pF	2.7nF	5.6nF	1.2nF	5.6nF	10nF	1.5nF	5.6nF	10nF	2.2nF	8.2nF	15nF	2.7nF	10nF	18nF	4.7nF	18nF	33nF
		Extended	-	-	1.5nF	3.9nF	12nF	2.2nF	8.2nF	-	2.2nF	6.8nF	22nF	3.3nF	12nF	-	4.7nF	15nF	47nF	8.2nF	27nF	82nF
	2kV	Standard	-	-	390pF	1.5nF	3.3nF	680pF	2.7nF	5.6nF	470pF	2.7nF	5.6nF	820pF	4.7nF	6.8nF	1.2nF	5.6nF	10nF	3.3nF	10nF	18nF
		Extended	470pF	2.7nF	820pF	2.2nF	5.6nF	1.2nF	3.9nF	-	1nF	3.9nF	12nF	1.8nF	6.8nF	-	2.7nF	8.2nF	27nF	6.8nF	15nF	47nF
	3kV	Standard	-	-	180pF	680pF	1.2nF	180pF	1.2nF	2.2nF	220pF	1.2nF	2.2nF	330pF	1.8nF	3.3nF	470pF	2.2nF	3.9nF	820pF	3.9nF	6.8nF
		Extended	220pF	1nF	390pF	1nF	2.7nF	680pF	1.8nF	-	470pF	1.8nF	4.7nF	820pF	2.7nF	-	1nF	3.3nF	12nF	1.8nF	5.6nF	22nF
4kV	Standard	-	-	100pF	330pF	680pF	120pF	680pF	1nF	150pF	820pF	1.2nF	220pF	1.2nF	1.8nF	390pF	1.5nF	2.7nF	680pF	3.3nF	4.7nF	
	Extended	150pF	470pF	220pF	560pF	-	330pF	1nF	-	330pF	1.2nF	2.2nF	680pF	1.8nF	-	820pF	2.2nF	4.7nF	1.5nF	4.7nF	10nF	
5kV	Standard	-	-	-	-	-	-	-	-	100pF	560pF	820pF	150pF	820pF	1nF	270pF	1nF	1.8nF	470pF	2.2nF	3.3nF	
	Extended	-	-	-	-	-	-	-	-	220pF	820pF	1.5nF	320pF	1.2nF	-	560pF	1.5nF	3.3nF	1nF	2.7nF	6.8nF	

High Voltage Chips Capacitors

C Series

STANDARD RATINGS

Size	4040			5440			5550			6560			11283			16080			
Exxelia size code	83			84			89			85			87			88			
Dimensions inches (mm)	L*	0.400 ± 0.039 (10.16 ± 1)			0.539 ± 0.039 (13.7 ± 1)			0.551 ± 0.039 (14 ± 1)			0.650 ± 0.039 (16.5 ± 1)			1.122 ± 0.039 (28.5 ± 1)			1.555 ± 0.039 (39.5 ± 1)		
	W*	0.400 ± 0.039 (10.16 ± 1)			0.400 ± 0.039 (10.16 ± 1)			0.500 ± 0.039 (12.7 ± 1)			0.598 ± 0.039 (15.2 ± 1)			0.827 ± 0.039 (21 ± 1)			0.756 ± 0.039 (19.2 ± 1)		
	a	0.059 ± 0.020 (1.5 ± 0.5)			0.059 ± 0.020 (1.5 ± 0.5)			0.059 ± 0.020 (1.5 ± 0.5)			0.059 ± 0.020 (1.5 ± 0.5)			0.059 ± 0.020 (1.5 ± 0.5)			0.059 ± 0.020 (1.5 ± 0.5)		
	d	0.138 ± 0.008 (3.5 ± 0.2)			0.138 ± 0.008 (3.5 ± 0.2)			0.138 ± 0.008 (3.5 ± 0.2)			0.138 ± 0.008 (3.5 ± 0.2)			0.138 ± 0.008 (3.5 ± 0.2)			0.138 ± 0.008 (3.5 ± 0.2)		
	b	0.315 ± 0.020 (8 ± 0.5)			0.315 ± 0.020 (8 ± 0.5)			0.315 ± 0.020 (8 ± 0.5)			0.591 ± 0.020 (15 ± 0.5)			0.591 ± 0.020 (15 ± 0.5)			0.591 ± 0.020 (15 ± 0.5)		
	R min.	0.275 (7)			0.393 (10)			0.393 (10)			0.511 (13)			0.984 (25)			1.377 (35)		
	C max.	0.473 (12)			0.611 (15.5)			0.63 (16)			0.729 (18.5)			1.26 (32)			1.654 (42)		
	X	0.45 ± 0.020 (11.43 ± 0.5)			0.551 ± 0.020 (14 ± 0.5)			0.563 ± 0.020 (14.3 ± 0.5)			0.7 ± 0.020 (17.78 ± 0.5)			1.15 ± 0.020 (29.21 ± 0.5)			1.6 ± 0.020 (40.64 ± 0.5)		
	Leads per side	4			4			5			6			6			6		
	T max.*	0.2kV up to 3kV: 0.158 (4) 4kV: 0.197 (5) 5kV up to 10kV: 0.237 (6)			0.2kV up to 3kV: 0.158 (4) 4kV: 0.197 (5) 5kV up to 10kV: 0.237 (6)			0.2kV up to 3kV: 0.158 (4) 4kV: 0.197 (5) 5kV up to 10kV: 0.237 (6)			0.2kV up to 3kV: 0.158 (4) 4kV: 0.197 (5) 5kV up to 10kV: 0.237 (6)			0.2kV up to 3kV: 0.158 (4) 4kV: 0.197 (5) 5kV: 0.237 (6) 7.5kV up to 10kV: 0.256 (6.5)			0.2kV up to 3kV: 0.158 (4) 4kV: 0.197 (5) 5kV: 0.236 (6) 7.5kV up to 10kV: 0.256 (6.5)		
Dielectric																			
Exxelia ceramic code																			
Min. Capacitance value																			
Rated voltage (U _{RC})	Standard																		
	Extended																		
	Standard																		
	Extended																		
	Standard																		
	Extended																		
	Standard																		
	Extended																		
	Standard																		
	Extended																		
	Standard																		
	Extended																		
	Standard																		
	Extended																		
	Standard																		
	Extended																		
	Standard																		
	Extended																		

* For E, H and HW: add +0.020 inch (+0.5 mm) to L, W and T dimensions.
 The high voltage parts may require varnish or encapsulation to prevent surface arcing.
 Available capacitance values:
 NPO, C4xx dielectrics: E6, E12, E24 (see page 14). Specific values upon request.
 X7R dielectric: E6, E12 in standard (see page 14). Specific values upon request.
 The above table defines the standard products, other components may be built upon request.

HIGH VOLTAGE

TCF Series

High Voltage Conformal Coated Led Capacitors



According to
Available space ranges:
consult our detail
specifications

FEATURES

- Multilayer chip ceramic capacitors
- NPO, C4xx and X7R dielectrics
- Capacitance range: 10pf to 39µF
- Voltage range: 200 V_{DC} to 10,000 V_{DC}

PHYSICAL CHARACTERISTICS

CONSTRUCTION

Epoxy conformal coated radial leaded capacitors suited to through-hole circuits.

MARKING

Series, capacitance value, tolerance, rated voltage, date code.

ELECTRICAL SPECIFICATIONS

DIELECTRIC	NPO	C4xx	X7R
Dielectric code	1	4	2
Maximum ΔC/°C over temperature range without voltage	NA	NA	±15%
Temperature coefficient	{0±30} ppm/°C	{-2,200±500} ppm/°C	NA
Aging	None	None	≤ 2.5% per decade hour
Operating temperature	-55°C to +125°C		
Rated voltage (U_{RC})	200 V _{DC} to 10,000 V _{DC}	200 V _{DC} to 5,000 V _{DC}	200 V _{DC} to 10,000 V _{DC}
Dielectric withstanding voltage	2.5 U _{RC} for U _{RC} ≤ 500 V _{DC} 1.6 U _{RC} for U _{RC} ≥ 1,000 V _{DC} Extended range: 2 U _{RC} for U _{RC} ≤ 500 V _{DC} 1.3 U _{RC} for U _{RC} ≥ 1,000 V _{DC}	2.5 U _{RC} for U _{RC} = 200 V _{DC} 2 U _{RC} for U _{RC} = 500 V _{DC} 1.5 U _{RC} for U _{RC} > 1,000 V _{DC} 1.4 U _{RC} for U _{RC} > 1,000 V _{DC} Extended range: 1.5 U _{RC} for U _{RC} ≤ 500 V _{DC} 1.2 U _{RC} for U _{RC} ≥ 1,000 V _{DC}	2.5 U _{RC} for U _{RC} = 200 V _{DC} 2 U _{RC} for U _{RC} = 500 V _{DC} 1.5 U _{RC} for U _{RC} = 1,000 V _{DC} 1.2 U _{RC} for U _{RC} > 1,000 V _{DC} Extended range: 1.5 U _{RC} for U _{RC} ≤ 500 V _{DC} 1.2 U _{RC} for U _{RC} ≥ 1,000 V _{DC}
Capacitance	at 1MHz for C ≤ 1,000pf at 1kHz for C > 1,000pf	at 1kHz	at 1kHz
Dissipation factor	≤ 0.015 (150/C + 7)% at 1MHz for C ≤ 50pf ≤ 0.15% at 1MHz for 50pf < C ≤ 1,000pf ≤ 0.15% at 1kHz for C > 1,000pf	≤ 0.10% at 1 kHz	≤ 2.5% at 1 kHz
Insulation resistance at 25°C under U_{RC} for U_{RC} ≤ 500 V under 500 V_{DC} for U_{RC} > 500 V	≥ 100,000 MΩ for C ≤ 10nf ≥ 1,000 MΩ.µF for C > 10nf	≥ 20,000 MΩ for C ≤ 25nf ≥ 500 MΩ.µF for C > 25nf	
Voltage proof body insulation	under U _{RC} for U _{RC} ≤ 1,250 V _{DC} under 1,300 V _{DC} for U _{RC} > 1,250 V _{DC}		

HOW TO ORDER

TCF	1	82	W	F	680pF	10%	4,000 V	B
Series	Dielectric code	Exxelia size code	RoHS compliant	Quality level	Capacitance	Tolerance	Rated voltage	Reliability level
TCF = Conformal coated radial leaded capacitor	1 = NPO 2 = X7R 4 = C4xx	79 90 80 91 81 82 83 84 89 85 87 88	- = No RoHS W = RoHS compliant	- = standard quality level F = Hi-Rel quality: screening in accordance with Exxelia specification	Capacitance value in clear	NPO dielectric: ±1% ±2% ±5% ±10% ±20% C4xx dielectric: ±2% ±5% ±10% ±20% X7R dielectric: ±10% ±20%	200 V 500 V 1,000 V 1,500 V 2,000 V 3,000 V 4,000 V 5,000 V 7,500 V 10,000 V Intermediary and higher voltages available: contact your sales representative.	For F parts only. Acc. to Exxelia spec. - T5 T6 See page 15

High Voltage Conformal Coated Leaded Capacitors

TCF Series

DIMENSIONS in inches (mm)

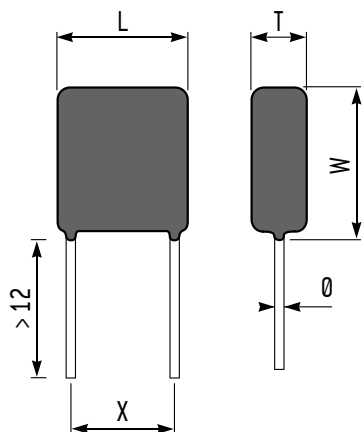

STANDARD RATINGS

		Exxelia size code	78	79	90	80	91	81	82													
Dimensions inches (mm)	L max.		0.249 (6.3)	0.256 (6.5)	0.256 (6.5)	0.315 (8)	0.319 (8.1)	0.394 (10)	0.414 (10.5)													
	W max.		0.229 (5.8)	0.237 (6)	0.355 (9)	0.355 (9)	0.355 (9)	0.355 (9)	0.453 (11.5)													
	T max.		0.205 (5.2)	0.197 (5)	0.197 (5)	0.197 (5)	0.2kV up to 3kV: 0.237 (6) 4kV-5kV: 0.276 (?)	0.2kV up to 3kV: 0.237 (6) 4kV: 0.276 (?) 5kV: 0.315 (8)	0.2kV up to 3kV: 0.237 (6) 4kV: 0.276 (?) 5kV: 0.315 (8)													
	Ø ± 10%		0.024 (0.6)	0.024 (0.6)	0.024 (0.6)	0.024 (0.6)	0.024 (0.6)	0.031 (0.8)	0.031 (0.8)													
	X		0.2 ± 0.02 (5.08 ± 0.5)	0.2 ± 0.012 (5.08 ± 0.3)	0.2 ± 0.012 (5.08 ± 0.3)	0.2 ± 0.012 (5.08 ± 0.3)	0.2 ± 0.012 (5.08 ± 0.3)	0.3 ± 0.012 (7.62 ± 0.3)	0.4 ± 0.012 (10.16 ± 0.3)													
Dielectric		NPO	X7R	NPO	C4xx	X7R	NPO	C4xx	X7R	NPO	C4xx	X7R	NPO	C4xx	X7R	NPO	C4xx	X7R				
Exxelia ceramic code		1	2	1	4	2	1	4	2	1	4	2	1	4	2	1	4	2				
Min. Capacitance value		12pF	120pF	10pF	27pF	100pF	10pF	33pF	150pF	10pF	33pF	150pF	15pF	47pF	150pF	18pF	56pF	150pF	33pF	82pF	330pF	
Rated voltage (U _{IRC})	0.2kV	Standard	-	-	5.6nF	120nF	220nF	12nF	220nF	470nF	12nF	220nF	390nF	15nF	330nF	560nF	18nF	390nF	820nF	33nF	680nF	1.5µF
		Extended	-	-	18nF	-	470nF	27nF	-	-	22nF	-	1µF	39nF	-	-	56nF	-	1.8µF	100nF	-	2.7µF
	0.5kV	Standard	-	-	3.3nF	22nF	47nF	6.8nF	47nF	100nF	5.6nF	47nF	100nF	6.8nF	68nF	150nF	8.2nF	82nF	220nF	22nF	120nF	390nF
		Extended	-	-	10nF	39nF	150nF	18nF	68nF	-	18nF	68nF	270nF	22nF	100nF	-	27nF	120nF	560nF	68nF	220nF	1µF
	1kV	Standard	-	-	1.8nF	6.8nF	15nF	2.7nF	12nF	24nF	2.2nF	12nF	22nF	3.3nF	18nF	33nF	3.9nF	22nF	47nF	10nF	39nF	68nF
		Extended	820pF	12nF	5.6nF	10nF	27nF	8.2nF	15nF	-	6.8nF	15nF	56nF	10nF	22nF	-	12nF	27nF	120nF	33nF	56nF	220nF
	1.5kV	Standard	-	-	820pF	2.7nF	5.6nF	1.2nF	5.6nF	10nF	1.5nF	5.6nF	10nF	2.2nF	8.2nF	15nF	2.7nF	10nF	18nF	4.7nF	18nF	33nF
		Extended	-	-	1.5nF	3.9nF	12nF	2.2nF	8.2nF	-	2.2nF	6.8nF	22nF	3.3nF	12nF	-	4.7nF	15nF	47nF	8.2nF	27nF	82nF
	2kV	Standard	-	-	390pF	1.5nF	3.3nF	680pF	2.7nF	5.6nF	470pF	2.7nF	5.6nF	820pF	4.7nF	6.8nF	1.2nF	5.6nF	10nF	3.3nF	10nF	18nF
		Extended	470pF	2.7nF	820pF	2.2nF	5.6nF	1.2nF	3.9nF	-	1nF	3.9nF	12nF	1.8nF	6.8nF	-	2.7nF	8.2nF	27nF	6.8nF	15nF	47nF
	3kV	Standard	-	-	180pF	680pF	1.2nF	180pF	1.2nF	2.2nF	220pF	1.2nF	2.2nF	330pF	1.8nF	3.3nF	470pF	2.2nF	3.9nF	820pF	3.9nF	6.8nF
		Extended	220pF	1nF	390pF	1nF	2.7nF	680pF	1.8nF	-	470pF	1.8nF	4.7nF	820pF	2.7nF	-	1nF	3.3nF	12nF	1.8nF	5.6nF	22nF
	4kV	Standard	-	-	100pF	330pF	680pF	120pF	680pF	1nF	150pF	820pF	1.2nF	220pF	1.2nF	1.8nF	390pF	1.5nF	2.7nF	680pF	3.3nF	4.7nF
		Extended	150pF	470pF	220pF	560pF	-	330pF	1nF	-	330pF	1.2nF	2.2nF	680pF	1.8nF	-	820pF	2.2nF	4.7nF	1.5nF	4.7nF	10nF
	5kV	Standard	-	-	-	-	-	-	-	-	100pF	560pF	820pF	150pF	820pF	1nF	270pF	1nF	1.8nF	470pF	2.2nF	3.3nF
		Extended	-	-	-	-	-	-	-	-	220pF	820pF	1.5nF	320pF	1.2nF	-	560pF	1.5nF	3.3nF	1nF	2.7nF	6.8nF

Available capacitance values:
 NPO, C4xx dielectrics: E6, E12, E24 (see page 14). Specific values upon request.
 X7R dielectric: E6, E12 in standard (see page 14). Specific values upon request.
 The above table defines the standard products, other components may be built upon request.

HIGH VOLTAGE

TCF Series

High Voltage Conformal Coated Leaded Capacitors

STANDARD RATINGS

		Exxelia size code	83			84			89			85			87			88																												
Dimensions Inches (mm)	L max.		0.552 [14]			0.689 [17.5]			0.701 [17.8]			0.788 [20]			1.221 [31]			1.772 [45]																												
	W max.		0.571 [14.5]			0.571 [14.5]			0.689 [17.5]			0.749 [19]			0.945 [24]			0.906 [23]																												
	T max.		0.2kV up to 3kV: 0.237 (6) 4kV: 0.276 (7) 5kV up to 10kV: 0.315 (8)			0.2kV up to 3kV: 0.237 (6) 4kV: 0.276 (7) 5kV up to 10kV: 0.315 (8)			0.2kV up to 3kV: 0.237 (6) 4kV: 0.276 (7) 5kV up to 10kV: 0.315 (8)			0.2kV up to 3kV: 0.237 (6) 4kV: 0.276 (7) 5kV up to 10kV: 0.315 (8)			0.2kV up to 3kV: 0.237 (6) 4kV: 0.276 (7) 5kV: 0.315 (8) 7.5kV up to 10kV: 0.335 (8.5)			0.2kV up to 3kV: 0.237 (6) 4kV: 0.276 (7) 5kV: 0.315 (8) 7.5kV up to 10kV: 0.335 (8.5)																												
	Ø ± 10%		0.031 [0.8]			0.031 [0.8]			0.031 [0.8]			0.031 [0.8]			0.039 [1]			0.039 [1]																												
	X		0.5 ± 0.012 [12.7 ± 0.3]			0.6 ± 0.012 [15.24 ± 0.3]			0.6 ± 0.012 [15.24 ± 0.3]			0.7 ± 0.012 [17.8 ± 0.3]			1.1 ± 0.012 [27.94 ± 0.3]			1.6 ± 0.012 [40.64 ± 0.3]																												
Dielectric		NPO			C4xx			X7R			NPO			C4xx			X7R																													
Exxelia ceramic code		1			4			2			1			4			2																													
Min. Capacitance value		10pF			180pF			270pF			22pF			390pF			560pF			47pF			470pF			1nF			120pF			1nF			2.2nF			150pF			1.8nF			2.7nF		
Rated voltage (U _{ric})	0.2kV	Standard	56nF	1.2µF	2.7µF	82nF	1.5µF	3.9µF	100nF	1.8µF	4.7µF	180nF	2.7µF	6.8µF	330nF	6.8µF	12µF	390nF	8.2µF	15µF																										
		Extended	180nF	-	5.6µF	270nF	-	6.8µF	220nF	-	8.2µF	560nF	-	12µF	1µF	-	33µF	1.2µF	-	39µF																										
	0.5kV	Standard	33nF	270nF	680nF	47nF	330nF	1µF	56nF	390nF	1.2µF	82nF	680nF	1.8µF	150nF	1.5µF	3.9µF	270nF	1.8µF	4.7µF																										
		Extended	100nF	390nF	1.5µF	150nF	560nF	2.2µF	150nF	680nF	2.7µF	270nF	1µF	3.9µF	470nF	2.2µF	10µF	820nF	2.7µF	12µF																										
	1kV	Standard	15nF	82nF	150nF	22nF	82nF	220nF	33nF	120nF	270nF	39nF	220nF	390nF	82nF	560nF	1µF	150nF	680nF	1.2µF																										
		Extended	47nF	120nF	390nF	68nF	120nF	560nF	82nF	220nF	560nF	120nF	330nF	1µF	270nF	680nF	2.7µF	470nF	1µF	3.3µF																										
	1.5kV	Standard	8.2nF	39nF	82nF	12nF	39nF	100nF	15nF	68nF	150nF	22nF	100nF	180nF	47nF	220nF	470nF	68nF	330nF	560nF																										
		Extended	18nF	56nF	180nF	22nF	56nF	220nF	33nF	100nF	330nF	47nF	150nF	470nF	100nF	330nF	1.2µF	150nF	470nF	1.5µF																										
	2kV	Standard	4.7nF	18nF	33nF	6.8nF	22nF	68nF	8.2nF	39nF	68nF	12nF	56nF	100nF	27nF	120nF	220nF	39nF	180nF	330nF																										
		Extended	10nF	27nF	100nF	15nF	33nF	150nF	18nF	56nF	150nF	27nF	82nF	220nF	56nF	180nF	560nF	82nF	270nF	820nF																										
	3kV	Standard	1.5nF	8.2nF	15nF	2.7nF	10nF	27nF	3.3nF	18nF	27nF	4.7nF	27nF	39nF	12nF	56nF	100nF	15nF	68nF	120nF																										
		Extended	3.3nF	12nF	39nF	5.6nF	15nF	56nF	10nF	22nF	68nF	10nF	39nF	100nF	27nF	82nF	270nF	33nF	100nF	330nF																										
	4kV	Standard	1.2nF	6.8nF	10nF	2.2nF	6.8nF	15nF	2.7nF	12nF	18nF	3.9nF	18nF	27nF	10nF	39nF	68nF	12nF	47nF	100nF																										
		Extended	2.7nF	10nF	18nF	4.7nF	10nF	27nF	6.8nF	18nF	39nF	8.2nF	27nF	47nF	22nF	56nF	120nF	27nF	82nF	150nF																										
	5kV	Standard	1nF	4.7nF	5.6nF	1.8nF	4.7nF	10nF	1.8nF	8.2nF	12nF	3.3nF	12nF	18nF	8.2nF	27nF	56nF	10nF	33nF	68nF																										
		Extended	2.2nF	6.8nF	15nF	3.9nF	6.8nF	22nF	4.7nF	12nF	27nF	6.8nF	18nF	39nF	15nF	39nF	82nF	18nF	47nF	100nF																										
	7.5kV	Standard	150pF	-	1.5nF	270pF	-	2.7nF	470pF	-	3.3nF	560pF	-	6.8nF	1.5nF	-	18nF	2.2nF	-	27nF																										
		Extended	330pF	-	3.3nF	560pF	-	5.6nF	1.2nF	-	6.8nF	1.2nF	-	12nF	3.3nF	-	33nF	4.7nF	-	47nF																										
	10kV	Standard	100pF	-	680pF	180pF	-	1.2nF	270pF	-	1.5nF	390pF	-	3.3nF	1nF	-	8.2nF	1.5nF	-	12nF																										
		Extended	220pF	-	1.8nF	390pF	-	3.3nF	680pF	-	3.9nF	820pF	-	6.8nF	2.2nF	-	15nF	3.3nF	-	27nF																										

Available capacitance values:

NPO, C4xx dielectrics: E6, E12, E24 (see page 14). Specific values upon request.

X7R dielectric: E6, E12 in standard (see page 14). Specific values upon request.

The above table defines the standard products, other components may be built upon request.

High Voltage Conformal Coated Leaded Capacitors

TKD Series



According to
Available space ranges:
consult our detail
specifications

ELECTRICAL SPECIFICATIONS

DIELECTRIC	NPO	C4xx	X7R
Dielectric code	1	4	2
Maximum $\Delta C/^\circ C$ over temperature range without voltage	NA	NA	$\pm 15\%$
Temperature coefficient	(0 ± 30) ppm/ $^\circ C$	$(-2,200 \pm 500)$ ppm/ $^\circ C$	NA
Aging	None	None	$\leq 2.5\%$ per decade hour
Operating temperature	$-55^\circ C$ to $+125^\circ C$		
Rated voltage (U_{RC})	250 V_{DC} to 10,000 V_{DC}	250 V_{DC} to 5,000 V_{DC}	250 V_{DC} to 10,000 V_{DC}
Dielectric withstanding voltage	2.5 U_{RC} for $U_{RC} \leq 500 V_{DC}$ 1.6 U_{RC} for $U_{RC} \geq 1,000 V_{DC}$ Extended range: 2 U_{RC} for $U_{RC} \leq 500 V_{DC}$ 1.3 U_{RC} for $U_{RC} \geq 1,000 V_{DC}$	2.5 U_{RC} for $U_{RC} = 250 V_{DC}$ 2 U_{RC} for $U_{RC} = 500 V_{DC}$ 1.5 U_{RC} for $U_{RC} = 1,000 V_{DC}$ 1.4 U_{RC} for $U_{RC} > 1,000 V_{DC}$ Extended range: 1.5 U_{RC} for $U_{RC} \leq 500 V_{DC}$ 1.2 U_{RC} for $U_{RC} \geq 1,000 V_{DC}$	2.5 U_{RC} for $U_{RC} = 250 V_{DC}$ 2 U_{RC} for $U_{RC} = 500 V_{DC}$ 1.5 U_{RC} for $U_{RC} = 1,000 V_{DC}$ 1.2 U_{RC} for $U_{RC} > 1,000 V_{DC}$ Extended range: 1.5 U_{RC} for $U_{RC} \leq 500 V_{DC}$ 1.2 U_{RC} for $U_{RC} \geq 1,000 V_{DC}$
Capacitance	at 1MHz for $C \leq 1,000$ pf at 1kHz for $C > 1,000$ pf		at 1kHz
Dissipation factor	$\leq 0.015 (150/C + 7)\%$ at 1MHz for $C \leq 50$ pf $\leq 0.15\%$ at 1MHz for 50 pf $< C \leq 1,000$ pf $\leq 0.15\%$ at 1kHz for $C > 1,000$ pf	$\leq 0.1\%$ at 1kHz	$\leq 2.5\%$ at 1kHz
Insulation resistance at 25$^\circ C$ under U_{RC} for $U_{RC} \leq 500 V$ under 500 V_{DC} for $U_{RC} > 500 V$	$\geq 100,000 M\Omega$ for $C \leq 10$ nf $\geq 1,000 M\Omega \cdot \mu F$ for $C > 10$ nf	$\geq 20,000 M\Omega$ for $C \leq 25$ nf $\geq 500 M\Omega \cdot \mu F$ for $C > 25$ nf	
Voltage proof body insulation	under U_{RC} for $U_{RC} \leq 1,250 V_{DC}$ under 1,300 V_{DC} for $U_{RC} > 1,250 V_{DC}$		

FEATURES

- Multilayer chip ceramic capacitors
- NPO, C4xx and X7R dielectrics
- Capacitance range: 10pf to 39 μF
- Voltage range: 250 V_{DC} to 10,000 V_{DC}

PHYSICAL CHARACTERISTICS

CONSTRUCTION

Epoxy conformal coated radial leaded capacitors suited to through-hole circuits.

MARKING

Series, capacitance value, tolerance, rated voltage, date code.

DIMENSIONS in inches (mm)

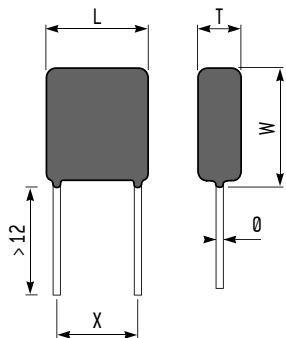

HOW TO ORDER

TKD	1	82	W	F	680pF	10%	4,000 V	B
Series	Dielectric code	Exxelia size code	RoHS compliant	Quality level	Capacitance	Tolerance	Rated voltage	Reliability level
TKD = Conformal coated radial leaded capacitor	1 = NPO 2 = X7R 4 = C4xx	79 90 80 91 82 83 84 89 85 87 88	- = No RoHS W = RoHS compliant	- = standard quality level F = Hi-Rel quality: screening in accordance with Exxelia specification	Capacitance value in clear	<u>NPO dielectric:</u> $\pm 1\%$ $\pm 2\%$ $\pm 5\%$ $\pm 10\%$ $\pm 20\%$ <u>C4xx dielectric:</u> $\pm 2\%$ $\pm 5\%$ $\pm 10\%$ $\pm 20\%$ <u>X7R dielectric:</u> $\pm 10\%$ $\pm 20\%$	200 V 500 V 1,000 V 1,500 V 2,000 V 3,000 V 4,000 V 5,000 V 7,500 V 10,000 V Intermediary and higher voltages available: contact your sales representative.	For F parts only. Acc. to Exxelia spec. - T5 T6 See page 15

TKD Series

High Voltage Conformal Coated Leaded Capacitors

STANDARD RATINGS

		Exxelia size code 79			90			80			91			81			82			
Dimensions inches (mm)	L max.	0.25 (6.35)			0.256 (6.5)			0.319 (8.1)			0.319 (8.1)			0.371 (9.4)			0.469 (11.9)			
	W max.	0.221 (5.6)			0.355 (9)			0.296 (7.5)			0.355 (9)			0.327 (8.3)			0.414 (10.5)			
	T max.	0.197 (5)			0.217 (5.5)			0.25 (6.35)			0.25 (6.35)			0.25 (6.35)			0.25 (6.35)			
	Ø ± 10%	0.024 (0.6)			0.024 (0.6)			0.024 (0.6)			0.024 (0.6)			0.024 (0.6)			0.024 (0.6)			
	X	0.169 ± 0.020 (4.3 ± 0.5)			0.169 ± 0.020 (4.3 ± 0.5)			0.220 ± 0.020 (5.6 ± 0.5)			0.220 ± 0.020 (5.6 ± 0.5)			0.276 ± 0.020 (7.0 ± 0.5)			0.374 ± 0.020 (9.5 ± 0.5)			
Dielectric		NPO	C4xx	X7R	NPO	C4xx	X7R	NPO	C4xx	X7R	NPO	C4xx	X7R	NPO	C4xx	X7R	NPO	C4xx	X7R	
Exxelia ceramic code		1	4	2	1	4	2	1	4	2	1	4	2	1	4	2	1	4	2	
Min. Capacitance value		10pF	27pF	100pF	10pF	33pF	150pF	10pF	33pF	150pF	15pF	47pF	150pF	18pF	56pF	150pF	33pF	82pF	330pF	
Rated voltage (U _{RC})	0.2kV	Standard	5.6nF	100nF	220nF	12nF	180nF	470nF	12nF	180nF	390nF	15nF	330nF	560nF	18nF	270nF	820nF	33nF	560nF	1.5µF
		Extended	15nF	-	470nF	27nF	-	-	22nF	-	1µF	39nF	-	-	47nF	-	1.8µF	82nF	-	2.7µF
	0.5kV	Standard	3.3nF	22nF	47nF	6.8nF	47nF	100nF	5.6nF	47nF	100nF	6.8nF	68nF	150nF	8.2nF	82nF	220nF	22nF	120nF	390nF
		Extended	10nF	39nF	150nF	18nF	68nF	-	18nF	68nF	220nF	22nF	100nF	-	27nF	120nF	560nF	68nF	220nF	1µF
	1kV	Standard	1.8nF	6.8nF	15nF	2.7nF	12nF	24nF	2.2nF	12nF	27nF	3.3nF	18nF	33nF	3.9nF	22nF	47nF	10nF	39nF	68nF
		Extended	5.6nF	10nF	27nF	8.2nF	15nF	-	6.8nF	15nF	56nF	10nF	22nF	-	12nF	27nF	120nF	33nF	56nF	220nF
	1.5kV	Standard	820pF	2.7nF	5.6nF	1.2nF	5.6nF	10nF	1.5nF	5.6nF	10nF	2.2nF	8.2nF	15nF	2.7nF	10nF	18nF	4.7nF	18nF	33nF
		Extended	1.5nF	3.9nF	12nF	2.2nF	8.2nF	-	2.2nF	6.8nF	22nF	3.3nF	12nF	-	4.7nF	15nF	47nF	8.2nF	27nF	82nF
	2kV	Standard	390pF	1.5nF	3.3nF	680pF	2.7nF	5.6nF	470pF	2.7nF	5.6nF	820pF	4.7nF	6.8nF	1.2nF	5.6nF	10nF	3.3nF	10nF	18nF
		Extended	820pF	2.2nF	5.6nF	1.2nF	3.9nF	-	1nF	3.9nF	12nF	1.8nF	6.8nF	-	2.7nF	8.2nF	27nF	6.8nF	15nF	47nF
	3kV	Standard	180pF	680pF	1.2nF	180pF	1.2nF	2.2nF	220pF	1.2nF	2.2nF	330pF	1.8nF	3.3nF	470pF	2.2nF	3.9nF	820pF	3.9nF	6.8nF
		Extended	390pF	1nF	2.7nF	680pF	1.8nF	-	470pF	1.8nF	4.7nF	820pF	2.7nF	-	1nF	3.3nF	12nF	1.8nF	5.6nF	22nF
	4kV	Standard	100pF	330pF	680pF	120pF	680pF	1nF	150pF	820pF	1.2nF	1.8nF	1.8nF	1.8nF	330pF	1.5nF	2.7nF	560pF	2.7nF	4.7nF
		Extended	220pF	560pF	-	330pF	1nF	-	330pF	1.2nF	2.2nF	680pF	1.8nF	-	820pF	2.2nF	4.7nF	1.5nF	3.9nF	10nF
	5kV	Standard	-	-	-	-	-	-	100pF	560pF	820pF	150pF	820pF	1nF	220pF	820pF	1.5nF	390pF	1.8nF	2.7nF
Extended		-	-	-	-	-	-	220pF	820pF	1.5nF	320pF	1.2nF	-	560pF	1.2nF	3.3nF	1nF	2.7nF	5.6nF	

		Exxelia size code 83			84			89			85			87			88			
Dimensions inches (mm)	L max.	0.569 (14.45)			0.67 (17)			0.701 (17.8)			0.77 (19.55)			1.221 (31)			1.772 (45)			
	W max.	0.504 (12.8)			0.552 (14)			0.689 (17.5)			0.749 (19)			0.945 (24)			0.906 (23)			
	T max.	0.27 (6.85)			0.27 (6.85)			0.27 (6.85)			0.27 (6.85)			0.27 (6.85)			0.27 (6.85)			
	Ø ± 10%	0.024 (0.6)			0.024 (0.6)			0.024 (0.6)			0.024 (0.6)			0.024 (0.6)			0.024 (0.6)			
	X	0.472 ± 0.020 (12.0 ± 0.5)			0.575 ± 0.020 (14.6 ± 0.5)			0.575 ± 0.020 (14.6 ± 0.5)			0.673 ± 0.020 (17.1 ± 0.5)			1.083 ± 0.020 (27.5 ± 0.5)			1.583 ± 0.020 (40.2 ± 0.5)			
Dielectric		NPO	C4xx	X7R	NPO	C4xx	X7R	NPO	C4xx	X7R	NPO	C4xx	X7R	NPO	C4xx	X7R	NPO	C4xx	X7R	
Exxelia ceramic code		1	4	2	1	4	2	1	4	2	1	4	2	1	4	2	1	4	2	
Min. Capacitance value		10pF	180pF	270pF	22pF	270pF	390pF	27pF	390pF	560pF	47pF	470pF	1nF	120pF	1nF	2.2nF	150pF	1.8nF	2.7nF	
Rated voltage (U _{RC})	0.2kV	Standard	56nF	1µF	270pF	22pF	270pF	390pF	27pF	390pF	560pF	47pF	470pF	1nF	120pF	1nF	2.2nF	150pF	1.8nF	2.7nF
		Extended	180nF	-	5.6µF	220nF	-	6.8µF	220nF	-	8.2µF	470nF	-	12µF	1µF	-	33µF	1.2µF	-	39µF
	0.5kV	Standard	33nF	270nF	680nF	47nF	330nF	1µF	56nF	390nF	1.2µF	82nF	680nF	1.8µF	150nF	1.5µF	3.9µF	270nF	1.8µF	4.7µF
		Extended	100nF	390nF	1.5µF	150nF	560nF	2.2µF	150nF	680nF	2.7µF	270nF	1µF	3.9µF	470nF	2.2µF	10µF	820nF	2.7µF	12µF
	1kV	Standard	15nF	82nF	150nF	22nF	82nF	220nF	33nF	120nF	270nF	39nF	220nF	390nF	82nF	560nF	1µF	150nF	680nF	1.2µF
		Extended	47nF	120nF	390nF	68nF	120nF	560nF	82nF	220nF	560nF	120nF	330nF	1µF	270nF	680nF	2.7µF	470nF	1µF	3.3µF
	1.5kV	Standard	8.2nF	39nF	82nF	12nF	39nF	100nF	15nF	68nF	150nF	22nF	100nF	180nF	47nF	220nF	470nF	68nF	330nF	560nF
		Extended	18nF	56nF	180nF	22nF	56nF	220nF	33nF	100nF	330nF	47nF	150nF	470nF	100nF	330nF	1.2µF	150nF	470nF	1.5µF
	2kV	Standard	4.7nF	18nF	33nF	6.8nF	22nF	68nF	8.2nF	39nF	68nF	12nF	56nF	100nF	27nF	120nF	220nF	39nF	180nF	330nF
		Extended	10nF	27nF	100nF	15nF	33nF	150nF	18nF	56nF	150nF	27nF	82nF	220nF	56nF	180nF	560nF	82nF	270nF	820nF
	3kV	Standard	1.5nF	8.2nF	15nF	2.7nF	10nF	27nF	3.3nF	18nF	27nF	4.7nF	27nF	39nF	12nF	56nF	100nF	15nF	68nF	120nF
		Extended	3.3nF	12nF	39nF	5.6nF	15nF	56nF	10nF	22nF	68nF	10nF	39nF	100nF	27nF	82nF	270nF	33nF	100nF	330nF
	4kV	Standard	1.2nF	5.6nF	10nF	2.2nF	6.8nF	15nF	2.7nF	12nF	18nF	3.9nF	15nF	27nF	8.2nF	39nF	68nF	12nF	47nF	100nF
		Extended	2.7nF	8.2nF	18nF	4.7nF	10nF	27nF	6.8nF	18nF	39nF	8.2nF	22nF	47nF	22nF	56nF	120nF	27nF	82nF	150nF
	5kV	Standard	1nF	3.9nF	5.6nF	1.8nF	4.7nF	10nF	1.8nF	8.2nF	12nF	3.3nF	12nF	18nF	6.8nF	22nF	56nF	6.8nF	33nF	68nF
Extended		2.2nF	5.6nF	15nF	3.3nF	6.8nF	22nF	4.7nF	12nF	27nF	6.8nF	18nF	39nF	15nF	33nF	68nF	18nF	47nF	100nF	
7.5kV	Standard	150pF	-	1.5nF	270pF	-	2.7nF	470pF	-	3.3nF	560pF	-	6.8nF	1.5nF	-	15nF	2.2nF	-	27nF	
	Extended	330pF	-	3.3nF	560pF	-	5.6nF	1.2nF	-	6.8nF	1.2nF	-	12nF	3.3nF	-	33nF	4.7nF	-	47nF	
10kV	Standard	100pF	-	680pF	180pF	-	1.2nF	270pF	-	1.5nF	390pF	-	3.3nF	1nF	-	8.2nF	1.5nF	-	12nF	
	Extended	220pF	-	1.8nF	390pF	-	3.3nF	680pF	-	3.9nF	820pF	-	6.8nF	2.2nF	-	15nF	3.3nF	-	22nF	

Available capacitance values:

NPO, C4xx dielectrics: E6, E12, E24 (see page 14). Specific values upon request.

X7R dielectric: E6, E12 in standard (see page 14). Specific values upon request.

The above table defines the standard products, other components may be built upon request.

High Voltage Varnished Leaded Capacitors

TCL Series



ELECTRICAL SPECIFICATIONS

DIELECTRIC	NPO	C4xx	X7R
Dielectric code	1	4	2
Maximum ΔC/°C over temperature range without voltage	NA	NA	±15%
Temperature coefficient	(0±30) ppm/°C	(-2,200±500) ppm/°C	NA
Aging	None	None	≤ 2.5% per decade hour
Operating temperature	-55°C to +125°C		
Rated voltage (U_{RC})	200 V _{DC} to 10,000 V _{DC}	200 V _{DC} to 5,000 V _{DC}	200 V _{DC} to 10,000 V _{DC}
Dielectric withstanding voltage	2.5 U _{RC} for U _{RC} ≤ 500 V _{DC} 1.6 U _{RC} for U _{RC} ≥ 1,000 V _{DC} Extended range: 2 U _{RC} for U _{RC} ≤ 500 V _{DC} 1.3 U _{RC} for U _{RC} ≥ 1,000 V _{DC}	2.5 U _{RC} for U _{RC} = 200 V _{DC} 2 U _{RC} for U _{RC} = 500 V _{DC} 1.5 U _{RC} for U _{RC} = 1,000 V _{DC} 1.4 U _{RC} for U _{RC} > 1,000 V _{DC} Extended range: 1.5 U _{RC} for U _{RC} ≤ 500 V _{DC} 1.2 U _{RC} for U _{RC} ≥ 1,000 V _{DC}	2.5 U _{RC} for U _{RC} = 200 V _{DC} 2 U _{RC} for U _{RC} = 500 V _{DC} 1.5 U _{RC} for U _{RC} = 1,000 V _{DC} 1.2 U _{RC} for U _{RC} > 1,000 V _{DC} Extended range: 1.5 U _{RC} for U _{RC} ≤ 500 V _{DC} 1.2 U _{RC} for U _{RC} ≥ 1,000 V _{DC}
Capacitance	at 1MHz for C ≤ 1,000pf at 1kHz for C > 1,000pf		at 1kHz
Dissipation factor	≤ 0.015 (150/C + 7)% at 1MHz for C ≤ 50pf ≤ 0.15% at 1MHz for 50pf < C ≤ 1,000pf ≤ 0.15% at 1kHz for C > 1,000pf	≤ 0.10% at 1kHz	≤ 2.5% at 1kHz
Insulation resistance at 25°C under U_{RC} for U_{RC} ≤ 500 V under 500 V_{DC} for U_{RC} > 500 V	≥ 100,000 MΩ for C ≤ 10nf ≥ 1,000 MΩ.μF for C > 10nf	≥ 20,000 MΩ for C ≤ 25nf ≥ 500 MΩ.μF for C > 25nf	

FEATURES

- Multilayer chip ceramic capacitors
- NPO, C4xx and X7R dielectrics
- Capacitance range: 10pf to 39 μF
- Voltage range: 200 V_{DC} to 10,000 V_{DC}

PHYSICAL CHARACTERISTICS

CONSTRUCTION

Varnished radial leaded chip capacitors for through-hole circuits. Models suited to applications for reduced size is required with minimum exposure to external constraint, or to assemblies potted by the user.

MARKING

Series, capacitance value, tolerance, rated voltage clear, date code.

HIGH VOLTAGE

HOW TO ORDER

TCL	1	82	W	F	680pF	10%	4,000 V	B
Series	Dielectric code	Exxelia size code	RoHS compliant	Quality level	Capacitance	Tolerance	Rated voltage	Reliability level
TCL = Varnished radial leaded capacitor	1 = NPO 2 = X7R 4 = C4xx	79 90 80 91 81 82 83 84 89 85 87 88	- = No RoHS W = RoHS compliant	- = standard quality level F = Hi-Rel quality: screening in accordance with Exxelia specification	Capacitance value in clear	<u>NPO dielectric:</u> ±1% ±2% ±5% ±10% ±20% <u>C4xx dielectric:</u> ±2% ±5% ±10% ±20% <u>X7R dielectric:</u> ±10% ±20%	200 V 500 V 1,000 V 1,500 V 2,000 V 3,000 V 4,000 V 5,000 V 7,500 V 10,000 V Intermediary and higher voltages available: contact your sales representative.	For F parts only. Acc. to Exxelia spec. - T5 T6 See page 15

TCL Series

High Voltage Varnished Leaded Capacitors

DIMENSIONS in inches (mm)

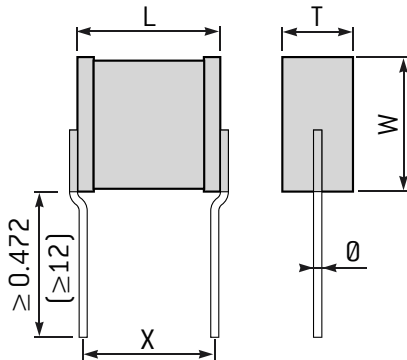

STANDARD RATINGS

		Exxelia size code			79			90			80			91			81			82																	
Dimensions inches (mm)	L max.	0.237 (6)			0.237 (6)			0.276 (7)			0.276 (7)			0.355 (9)			0.394 (10)																				
	W max.	0.197 (5)			0.296 (7.5)			0.276 (7)			0.296 (7.5)			0.296 (7.5)			0.394 (10)																				
	T max.	0.138 (3.5)			0.138 (3.5)			0.2kV up to 3kV: 0.118 (3) 4kV-5kV: 0.150 (3.8)			0.2kV up to 3kV: 0.158 (4) 4kV-5kV: 0.197 (5)			0.2kV up to 3kV: 0.158 (4) 4kV: 0.197 (5) 5kV: 0.237 (6)			0.2kV up to 3kV: 0.158 (4) 4kV: 0.197 (5) 5kV: 0.237 (6)																				
	Ø ± 10%	0.024 (0.6)			0.024 (0.6)			0.024 (0.6)			0.024 (0.6)			0.031 (0.8)			0.031 (0.8)																				
	X	0.2 ± 0.020 (5.08 ± 0.5)			0.2 ± 0.020 (5.08 ± 0.5)			0.2 ± 0.020 (5.08 ± 0.5)			0.2 ± 0.020 (5.08 ± 0.5)			0.3 ± 0.020 (7.62 ± 0.5)			0.4 ± 0.020 (10.16 ± 0.5)																				
Dielectric		NPO		C4xx		X7R		NPO		C4xx		X7R		NPO		C4xx		X7R		NPO		C4xx		X7R													
Exxelia ceramic code		1		4		2		1		4		2		1		4		2		1		4		2													
Min. Capacitance value		10pF		27pF		100pF		10pF		33pF		150pF		10pF		33pF		150pF		15pF		47pF		150pF		18pF		56pF		150pF		33pF		82pF		330pF	
Rated voltage (U _{RC})	0.2kV	Standard	5.6nF	120nF	220nF	12nF	220nF	470nF	12nF	220nF	390nF	15nF	330nF	560nF	18nF	390nF	820nF	33nF	680nF	1.5µF																	
		Extended	18nF	-	470nF	27nF	-	-	22nF	-	1µF	39nF	-	-	56nF	-	1.8µF	100nF	-	2.7µF																	
	0.5kV	Standard	3.3nF	22nF	47nF	6.8nF	47nF	100nF	5.6nF	47nF	100nF	6.8nF	68nF	150nF	8.2nF	82nF	220nF	22nF	120nF	390nF																	
		Extended	10nF	39nF	150nF	18nF	68nF	-	18nF	68nF	270nF	22nF	100nF	-	27nF	120nF	560nF	68nF	220nF	1µF																	
	1kV	Standard	1.8nF	6.8nF	15nF	2.7nF	12nF	24nF	2.2nF	12nF	22nF	3.3nF	18nF	33nF	3.9nF	22nF	47nF	10nF	39nF	68nF																	
		Extended	5.6nF	10nF	27nF	8.2nF	15nF	-	6.8nF	15nF	56nF	10nF	22nF	-	12nF	27nF	120nF	33nF	56nF	220nF																	
	1.5kV	Standard	820pF	2.7nF	5.6nF	1.2nF	5.6nF	10nF	1.5nF	5.6nF	10nF	2.2nF	8.2nF	15nF	2.7nF	10nF	18nF	4.7nF	18nF	33nF																	
		Extended	1.5nF	3.9nF	12nF	2.2nF	8.2nF	-	2.2nF	6.8nF	22nF	3.3nF	12nF	-	4.7nF	15nF	47nF	8.2nF	27nF	82nF																	
	2kV	Standard	390pF	1.5nF	3.3nF	680pF	2.7nF	5.6nF	470pF	2.7nF	5.6nF	820pF	4.7nF	6.8nF	1.2nF	5.6nF	10nF	3.3nF	10nF	18nF																	
		Extended	820pF	2.2nF	5.6nF	1.2nF	3.9nF	-	1nF	3.9nF	12nF	1.8nF	6.8nF	-	2.7nF	8.2nF	27nF	6.8nF	15nF	47nF																	
	3kV	Standard	180pF	680pF	1.2nF	180pF	1.2nF	2.2nF	220pF	1.2nF	2.2nF	330pF	1.8nF	3.3nF	470pF	2.2nF	3.9nF	820pF	3.9nF	6.8nF																	
		Extended	390pF	1nF	2.7nF	680pF	1.8nF	-	470pF	1.8nF	4.7nF	820pF	2.7nF	-	1nF	3.3nF	12nF	1.8nF	5.6nF	22nF																	
	4kV	Standard	100pF	330pF	680pF	120pF	680pF	1nF	150pF	820pF	1.2nF	220pF	1.2nF	1.8nF	390pF	1.5nF	2.7nF	680pF	3.3nF	4.7nF																	
		Extended	220pF	560pF	-	330pF	1nF	-	330pF	1.2nF	2.2nF	680pF	1.8nF	-	820pF	2.2nF	4.7nF	1.5nF	4.7nF	10nF																	
5kV	Standard	-	-	-	-	-	-	100pF	560pF	820pF	150pF	820pF	1nF	270pF	1nF	1.8nF	470pF	2.2nF	3.3nF																		
	Extended	-	-	-	-	-	-	220pF	820pF	1.5nF	320pF	1.2nF	-	560pF	1.5nF	3.3nF	1nF	2.7nF	6.8nF																		

High Voltage Varnished Leaded Capacitors

TCL Series

STANDARD RATINGS

		Exxelia size code			83			84			89			85			87			88																																			
Dimensions Inches (mm)	L max.	0.473 (12)			0.63 (16)			0.642 (16.3)			0.729 (18.5)			1.182 (30)			1.674 (42.5)																																						
	W max.	0.493 (12.5)			0.493 (12.5)			0.619 (15.7)			0.689 (17.5)			0.886 (22.5)			0.827 (21)																																						
	T max.	0.2kV up to 3kV: 0.158 (4) 4kV: 0.197 (5) 5kV up to 10kV: 0.237 (6)			0.2kV up to 3kV: 0.158 (4) 4kV: 0.197 (5) 5kV up to 10kV: 0.237 (6)			0.2kV up to 3kV: 0.158 (4) 4kV: 0.197 (5) 5kV up to 10kV: 0.237 (6)			0.2kV up to 3kV: 0.158 (4) 4kV: 0.197 (5) 5kV up to 10kV: 0.237 (6)			0.2kV up to 3kV: 0.158 (4) 4kV: 0.197 (5) 5kV: 0.237 (6) 7.5kV up to 10kV: 0.256 (6.5)			0.2kV up to 3kV: 0.158 (4) 4kV: 0.197 (5) 5kV: 0.237 (6) 7.5kV up to 10kV: 0.256 (6.5)																																						
	θ ± 10%	0.031 (0.8)			0.039 (1)			0.039 (1)			0.039 (1)			0.039 (1)			0.039 (1)																																						
	X	0.5 ± 0.020 (12.7 ± 0.5)			0.6 ± 0.020 (15.24 ± 0.5)			0.6 ± 0.020 (15.24 ± 0.5)			0.7 ± 0.020 (17.8 ± 0.5)			1.1 ± 0.020 (27.94 ± 0.5)			1.6 ± 0.020 (40.64 ± 0.5)																																						
Dielectric		NPO			C4xx			X7R			NPO			C4xx			X7R			NPO			C4xx			X7R																													
Exxelia ceramic code		1			4			2			1			4			2			1			4			2																													
Min. Capacitance value		10pF			180pF			270pF			22pF			270pF			390pF			27pF			390pF			560pF			47pF			470pF			1nF			120pF			1nF			2.2nF			150pF			1.8nF			2.7nF		
Rated voltage (U _{ric})	0.2kV	Standard	56nF	1.2µF	2.7µF	82nF	1.5µF	3.9µF	100nF	1.8µF	4.7µF	180nF	2.7µF	6.8µF	330nF	6.8µF	12µF	390nF	8.2µF	15µF																																			
		Extended	180nF	-	5.6µF	270nF	-	6.8µF	220nF	-	8.2µF	560nF	-	12µF	1µF	-	33µF	1.2µF	-	39µF																																			
	0.5kV	Standard	33nF	270nF	680nF	47nF	330nF	1µF	56nF	390nF	1.2µF	82nF	680nF	1.8µF	150nF	1.5µF	3.9µF	270nF	1.8µF	4.7µF																																			
		Extended	100nF	390nF	1.5µF	150nF	560nF	2.2µF	150nF	680nF	2.7µF	270nF	1µF	3.9µF	470nF	2.2µF	10µF	820nF	2.7µF	12µF																																			
	1kV	Standard	15nF	82nF	150nF	22nF	82nF	220nF	33nF	120nF	270nF	39nF	220nF	390nF	82nF	560nF	1µF	150nF	680nF	1.2µF																																			
		Extended	47nF	120nF	390nF	68nF	120nF	560nF	82nF	220nF	560nF	120nF	330nF	1µF	270nF	680nF	2.7µF	470nF	1µF	3.3µF																																			
	1.5kV	Standard	8.2nF	39nF	82nF	12nF	39nF	100nF	15nF	68nF	150nF	22nF	100nF	180nF	47nF	220nF	470nF	68nF	330nF	560nF																																			
		Extended	18nF	56nF	180nF	22nF	56nF	220nF	33nF	100nF	330nF	47nF	150nF	470nF	100nF	330nF	1.2µF	150nF	470nF	1.5µF																																			
	2kV	Standard	4.7nF	18nF	33nF	6.8nF	22nF	68nF	8.2nF	39nF	68nF	12nF	56nF	100nF	27nF	120nF	220nF	39nF	180nF	330nF																																			
		Extended	10nF	27nF	100nF	15nF	33nF	150nF	18nF	56nF	150nF	27nF	82nF	220nF	56nF	180nF	560nF	82nF	270nF	820nF																																			
	3kV	Standard	1.5nF	8.2nF	15nF	2.7nF	10nF	27nF	3.3nF	18nF	27nF	4.7nF	27nF	39nF	12nF	56nF	100nF	15nF	68nF	120nF																																			
		Extended	3.3nF	12nF	39nF	5.6nF	15nF	56nF	10nF	22nF	68nF	10nF	39nF	100nF	27nF	82nF	270nF	33nF	100nF	330nF																																			
	4kV	Standard	1.2nF	6.8nF	10nF	2.2nF	6.8nF	15nF	2.7nF	12nF	18nF	3.9nF	18nF	27nF	10nF	39nF	68nF	12nF	47nF	100nF																																			
		Extended	2.7nF	10nF	18nF	4.7nF	10nF	27nF	6.8nF	18nF	39nF	8.2nF	27nF	47nF	22nF	56nF	120nF	27nF	82nF	150nF																																			
	5kV	Standard	1nF	4.7nF	5.6nF	1.8nF	4.7nF	10nF	1.8nF	8.2nF	12nF	3.3nF	12nF	18nF	8.2nF	27nF	56nF	10nF	33nF	68nF																																			
		Extended	2.2nF	6.8nF	15nF	3.9nF	6.8nF	22nF	4.7nF	12nF	27nF	6.8nF	18nF	39nF	15nF	39nF	82nF	18nF	47nF	100nF																																			
	7.5kV	Standard	150pF	-	1.5nF	270pF	-	2.7nF	470pF	-	3.3nF	560pF	-	6.8nF	1.5nF	-	18nF	2.2nF	-	27nF																																			
		Extended	330pF	-	3.3nF	560pF	-	5.6nF	1.2nF	-	6.8nF	1.2nF	-	12nF	3.3nF	-	33nF	4.7nF	-	47nF																																			
	10kV	Standard	100pF	-	680pF	180pF	-	1.2nF	270pF	-	1.5nF	390pF	-	3.3nF	1nF	-	8.2nF	1.5nF	-	12nF																																			
		Extended	220pF	-	1.8nF	390pF	-	3.3nF	680pF	-	3.9nF	820pF	-	6.8nF	2.2nF	-	15nF	3.3nF	-	27nF																																			

HIGH VOLTAGE

Available capacitance values:
 NPO, C4xx dielectrics: E6, E12, E24 (see page 14). Specific values upon request.
 X7R dielectric: E6, E12 in standard (see page 14). Specific values upon request.
 The above table defines the standard products, other components may be built upon request.

TCK Series

High Voltage Molded Ledged Capacitors



According to
Available space ranges:
consult our detail
specifications

FEATURES

- Multilayer chip ceramic capacitors
- NPO, C4xx and X7R dielectrics
- Capacitance range: 10pf to 39 μ F
- Voltage range: 200 V_{DC} to 5,000 V_{DC}

PHYSICAL CHARACTERISTICS

CONSTRUCTION

Varnished radial ledged chip capacitors for through-hole circuits. Models suited to applications for reduced size is required with minimum exposure to external constraint, or to assemblies potted by the user.

MARKING

Series, capacitance value, tolerance, rated voltage coded, date code.

ELECTRICAL SPECIFICATIONS

DIELECTRIC	NPO	C4xx	X7R
Dielectric code	1	4	2
Maximum ΔC/°C over temperature range without voltage	NA	NA	$\pm 15\%$
Temperature coefficient	(0 \pm 30) ppm/°C	(-2,200 \pm 500) ppm/°C	NA
Aging	None	None	$\leq 2.5\%$ per decade hour
Operating temperature	-55°C to +125°C		
Rated voltage (U_{RC})	200 V _{DC} to 5,000 V _{DC}	200 V _{DC} to 5,000 V _{DC}	200 V _{DC} to 5,000 V _{DC}
Dielectric withstanding voltage	2.5 U _{RC} for U _{RC} \leq 500 V _{DC} 1.6 U _{RC} for U _{RC} \geq 1,000 V _{DC} Extended range: 2 U _{RC} for U _{RC} \leq 500 V _{DC} 1.3 U _{RC} for U _{RC} \geq 1,000 V _{DC}	2.5 U _{RC} for U _{RC} = 200 V _{DC} 2 U _{RC} for U _{RC} = 500 V _{DC} 1.5 U _{RC} for U _{RC} = 1,000 V _{DC} 1.4 U _{RC} for U _{RC} > 1,000 V _{DC} Extended range: 1.5 U _{RC} for U _{RC} \leq 500 V _{DC} 1.2 U _{RC} for U _{RC} \geq 1,000 V _{DC}	2.5 U _{RC} for U _{RC} = 200 V _{DC} 2 U _{RC} for U _{RC} = 500 V _{DC} 1.5 U _{RC} for U _{RC} = 1,000 V _{DC} 1.2 U _{RC} for U _{RC} > 1,000 V _{DC} Extended range: 1.5 U _{RC} for U _{RC} \leq 500 V _{DC} 1.2 U _{RC} for U _{RC} \geq 1,000 V _{DC}
Capacitance	at 1MHz for C \leq 1,000pf at 1kHz for C > 1,000pf	at 1kHz	at 1kHz
Dissipation factor	≤ 0.015 (150°C + 7)% at 1MHz for C \leq 50pf $\leq 0.15\%$ at 1MHz for 50pf < C \leq 1,000pf $\leq 0.15\%$ at 1kHz for C > 1,000pf	$\leq 0.10\%$ at 1kHz	$\leq 2.5\%$ at 1kHz
Insulation resistance at 25°C under U_{RC} for U_{RC} \leq 500 V under 500 V_{DC} for U_{RC} > 500 V	$\geq 100,000$ M Ω for C \leq 10nf $\geq 1,000$ M Ω . μ F for C > 10nf	$\geq 20,000$ M Ω for C \leq 25nf ≥ 500 M Ω . μ F for C > 25nf	
Voltage proof body insulation	Under U _{RC} for U _{RC} \leq 1,250 V _{DC} Under 1,300 V _{DC} for U _{RC} > 1,250 V _{DC}		

HOW TO ORDER

TCK	1	82	UL	W	F	680pF	10%	4,000 V	-	B
Series	Dielectric code	Exxelia size code	UL94V0 compliant	RoHS compliant	Quality level	Capacitance	Tolerance	Rated voltage	Packaging	Reliability level
TCK = Molded radial ledged capacitor	1 = NPO 2 = X7R 4 = C4xx	79 90 80 91 81 82 83 84 89 85 87 88	- = not UL compliant UL = UL94V0 compliant	- = No RoHS W = RoHS compliant	- = standard quality level F = Hi-Rel quality: screening in accordance with Exxelia specification	Capacitance value in clear	NPO dielectric: $\pm 1\%$ $\pm 2\%$ $\pm 5\%$ $\pm 10\%$ $\pm 20\%$ C4xx dielectric: $\pm 2\%$ $\pm 5\%$ $\pm 10\%$ $\pm 20\%$ X7R dielectric: $\pm 10\%$ $\pm 20\%$	200 V 500 V 1,000 V 1,500 V 2,000 V 3,000 V 4,000 V 5,000 V Intermediary and higher voltages available: contact your sales representative.	B = Reel option: Contact your sales representative.	For F parts only. Acc. to Exxelia spec. - T5 T6 See page 15

High Voltage Molded Leaded Capacitors

TCK Series

DIMENSIONS in inches (mm)

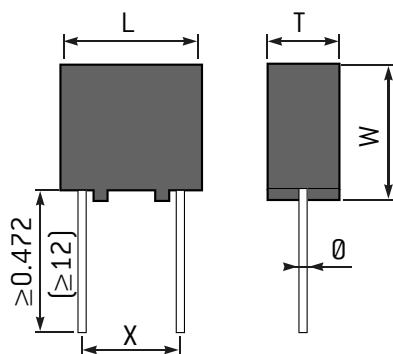

STANDARD RATINGS

Exxelia size code		79			90			80			91			81			82			
Dimensions inches (mm)	L	0.284 ± 0.020 (7.2 ± 0.5)			0.284 ± 0.020 (7.2 ± 0.5)			0.315 ± 0.020 (8 ± 0.5)			0.315 ± 0.020 (8 ± 0.5)			0.413 ± 0.020 (10.5 ± 0.5)			0.512 ± 0.020 (13 ± 0.5)			
	W	0.197 ± 0.020 (5 ± 0.5)			0.37 ± 0.020 (9.4 ± 0.5)			0.315 ± 0.020 (8 ± 0.5)			0.37 ± 0.020 (9.4 ± 0.5)			0.354 ± 0.020 (9 ± 0.5)			0.472 ± 0.020 (12 ± 0.5)			
	T max.	0.197 (5)			0.197 (5)			0.197 (5)			0.2kV up to 3kV: 0.256 (6.5) 4kV-5kV: 0.296 (7.5)			0.2kV up to 3kV: 0.256 (6.5) 4kV-5kV: 0.315 (8)			0.2kV up to 3kV: 0.256 (6.5) 4kV-5kV: 0.315 (8)			
	Ø ± 10%	0.024 (0.6)			0.024 (0.6)			0.024 (0.6)			0.024 (0.6)			0.031 (0.8)			0.031 (0.8)			
	X	0.2 ± 0.020 (5.08 ± 0.5)			0.2 ± 0.020 (5.08 ± 0.5)			0.2 ± 0.020 (5.08 ± 0.5)			0.2 ± 0.020 (5.08 ± 0.5)			0.3 ± 0.020 (7.62 ± 0.5)			0.4 ± 0.020 (10.16 ± 0.5)			
Dielectric		NPO		C4xx		X7R		NPO		C4xx		X7R		NPO		C4xx		X7R		
Exxelia ceramic code		1		4		2		1		4		2		1		4		2		
Min. Capacitance value		10pF		27pF		100pF		10pF		33pF		150pF		15pF		47pF		150pF		
Rated voltage (U _{RC})	0.2kV	Standard	5.6nF	120nF	220nF	12nF	220nF	470nF	12nF	220nF	390nF	15nF	330nF	560nF	18nF	390nF	820nF	33nF	680nF	1.5µF
		Extended	18nF	-	470nF	27nF	-	-	22nF	-	1µF	39nF	-	-	56nF	-	1.8µF	100nF	-	2.7µF
	0.5kV	Standard	3.3nF	22nF	47nF	6.8nF	47nF	100nF	5.6nF	47nF	100nF	6.8nF	68nF	150nF	8.2nF	82nF	220nF	22nF	120nF	390nF
		Extended	10nF	39nF	150nF	18nF	68nF	-	18nF	68nF	270nF	22nF	100nF	-	27nF	120nF	560nF	68nF	220nF	1µF
	1kV	Standard	1.8nF	6.8nF	15nF	2.7nF	12nF	24nF	2.2nF	12nF	22nF	3.3nF	18nF	33nF	3.9nF	22nF	47nF	10nF	39nF	68nF
		Extended	5.6nF	10nF	27nF	8.2nF	15nF	-	6.8nF	15nF	56nF	10nF	22nF	-	12nF	27nF	120nF	33nF	56nF	220nF
	1.5kV	Standard	820pF	2.7nF	5.6nF	1.2nF	5.6nF	10nF	1.5nF	5.6nF	10nF	2.2nF	8.2nF	15nF	2.7nF	10nF	18nF	4.7nF	18nF	33nF
		Extended	1.5nF	3.9nF	12nF	2.2nF	8.2nF	-	2.2nF	6.8nF	22nF	3.3nF	12nF	-	4.7nF	15nF	47nF	8.2nF	27nF	82nF
	2kV	Standard	390pF	1.5nF	3.3nF	680pF	2.7nF	5.6nF	470pF	2.7nF	5.6nF	820pF	4.7nF	6.8nF	1.2nF	5.6nF	10nF	3.3nF	10nF	18nF
		Extended	820pF	2.2nF	5.6nF	1.2nF	3.9nF	-	1nF	3.9nF	12nF	1.8nF	6.8nF	-	2.7nF	8.2nF	27nF	6.8nF	15nF	47nF
	3kV	Standard	180pF	680pF	1.2nF	180pF	1.2nF	2.2nF	220pF	1.2nF	2.2nF	330pF	1.8nF	3.3nF	470pF	2.2nF	3.9nF	820pF	3.9nF	6.8nF
		Extended	390pF	1nF	2.7nF	680pF	1.8nF	-	470pF	1.8nF	4.7nF	820pF	2.7nF	-	1nF	3.3nF	12nF	1.8nF	5.6nF	22nF
	4kV	Standard	100pF	330pF	680pF	120pF	680pF	1nF	150pF	820pF	1.2nF	220pF	1.2nF	1.8nF	390pF	1.5nF	2.7nF	680pF	3.3nF	4.7nF
		Extended	220pF	560pF	-	330pF	1nF	-	330pF	1.2nF	2.2nF	680pF	1.8nF	-	820pF	2.2nF	4.7nF	1.5nF	4.7nF	10nF
	5kV	Standard	-	-	-	-	-	-	100pF	560pF	820pF	150pF	820pF	1nF	270pF	1nF	1.8nF	470pF	2.2nF	3.3nF
		Extended	-	-	-	-	-	-	220pF	820pF	1.5nF	320pF	1.2nF	-	560pF	1.5nF	3.3nF	1nF	2.7nF	6.8nF

HIGH VOLTAGE

STANDARD RATINGS

		83			84			89			85			87			88			
Exxelia size code																				
Dimensions inches (mm)	L	0.591 ± 0.020 (15 ± 0.5)			0.709 ± 0.020 (18 ± 0.5)			0.732 ± 0.020 (18.6 ± 0.5)			0.787 ± 0.020 (20 ± 0.5)			1.221 ± 0.020 (31 ± 0.5)			1.772 ± 0.020 (45 ± 0.5)			
	W	0.551 ± 0.020 (14 ± 0.5)			0.630 ± 0.020 (16 ± 0.5)			0.697 ± 0.020 (17.7 ± 0.5)			0.748 ± 0.020 (19 ± 0.5)			0.945 ± 0.020 (24 ± 0.5)			0.906 ± 0.020 (23 ± 0.5)			
	T max.	0.2kV up to 3kV: 0.256 (6.5) 4kV up to 10kV: 0.315 (8)			0.2kV up to 3kV: 0.256 (6.5) 4kV up to 10kV: 0.315 (8)			0.2kV up to 3kV: 0.256 (6.5) 4kV up to 10kV: 0.315 (8)			0.2kV up to 3kV: 0.256 (6.5) 4kV up to 10kV: 0.315 (8)			0.2kV up to 3kV: 0.256 (6.5) 4kV up to 10kV: 0.315 (8)			0.2kV up to 3kV: 0.256 (6.5) 4kV up to 10kV: 0.355 (9)			
	Ø ± 10%	0.031 (0.8)			0.039 (1)			0.039 (1)			0.039 (1)			0.039 (1)			0.039 (1)			
	X	0.5 ± 0.020 (12.7 ± 0.5)			0.6 ± 0.020 (15.24 ± 0.5)			0.6 ± 0.020 (15.24 ± 0.5)			0.7 ± 0.020 (17.8 ± 0.5)			1.1 ± 0.020 (27.94 ± 0.5)			1.6 ± 0.020 (40.64 ± 0.5)			
Dielectric		NPO	C4xx	X7R	NPO	C4xx	X7R	NPO	C4xx	X7R	NPO	C4xx	X7R	NPO	C4xx	X7R	NPO	C4xx	X7R	
Exxelia ceramic code		1	4	2	1	4	2	1	4	2	1	4	2	1	4	2	1	4	2	
Min. Capacitance value		10pF	180pF	270pF	22pF	270pF	390pF	27pF	390pF	560pF	47pF	470pF	1nF	120pF	1nF	2.2nF	150pF	1.8nF	2.7nF	
Rated voltage (U _{ric})	0.2kV	Standard	56nF	1.2µF	2.7µF	82nF	1.5µF	3.9µF	100nF	1.8µF	4.7µF	180nF	2.7µF	6.8µF	330nF	6.8µF	12µF	390nF	8.2µF	15µF
		Extended	180nF	-	5.6µF	270nF	-	6.8µF	220nF	-	8.2µF	560nF	-	12µF	1µF	-	33µF	1.2µF	-	39µF
	0.5kV	Standard	33nF	270nF	680nF	47nF	330nF	1µF	56nF	390nF	1.2µF	82nF	680nF	1.8µF	150nF	1.5µF	3.9µF	270nF	1.8µF	4.7µF
		Extended	100nF	390nF	1.5µF	150nF	560nF	2.2µF	150nF	680nF	2.7µF	270nF	1µF	3.9µF	470nF	2.2µF	10µF	820nF	2.7µF	12µF
	1kV	Standard	15nF	82nF	150nF	22nF	82nF	220nF	33nF	120nF	270nF	39nF	220nF	390nF	82nF	560nF	1µF	150nF	680nF	1.2µF
		Extended	47nF	120nF	390nF	68nF	120nF	560nF	82nF	220nF	560nF	120nF	330nF	1µF	270nF	680nF	2.7µF	470nF	1µF	3.3µF
	1.5kV	Standard	8.2nF	39nF	82nF	12nF	39nF	100nF	15nF	68nF	150nF	22nF	100nF	180nF	47nF	220nF	470nF	68nF	330nF	560nF
		Extended	18nF	56nF	180nF	22nF	56nF	220nF	33nF	100nF	330nF	47nF	150nF	470nF	100nF	330nF	1.2µF	150nF	470nF	1.5µF
	2kV	Standard	4.7nF	18nF	33nF	6.8nF	22nF	68nF	8.2nF	39nF	68nF	12nF	56nF	100nF	27nF	120nF	220nF	39nF	180nF	330nF
		Extended	10nF	27nF	100nF	15nF	33nF	150nF	18nF	56nF	150nF	27nF	82nF	220nF	56nF	180nF	560nF	82nF	270nF	820nF
	3kV	Standard	1.5nF	8.2nF	15nF	2.7nF	10nF	27nF	3.3nF	18nF	27nF	4.7nF	27nF	39nF	12nF	56nF	100nF	15nF	68nF	120nF
		Extended	3.3nF	12nF	39nF	5.6nF	15nF	56nF	10nF	22nF	68nF	10nF	39nF	100nF	27nF	82nF	270nF	33nF	100nF	330nF
	4kV	Standard	1.2nF	6.8nF	10nF	2.2nF	6.8nF	15nF	2.7nF	12nF	18nF	3.9nF	18nF	27nF	10nF	39nF	68nF	12nF	47nF	100nF
		Extended	2.7nF	10nF	18nF	4.7nF	10nF	27nF	6.8nF	18nF	39nF	8.2nF	27nF	47nF	22nF	56nF	120nF	27nF	82nF	150nF
	5kV	Standard	1nF	4.7nF	5.6nF	1.8nF	4.7nF	10nF	1.8nF	8.2nF	12nF	3.3nF	12nF	18nF	8.2nF	27nF	56nF	10nF	33nF	68nF
		Extended	2.2nF	6.8nF	15nF	3.9nF	6.8nF	22nF	4.7nF	12nF	27nF	6.8nF	18nF	39nF	15nF	39nF	82nF	18nF	47nF	100nF

Available capacitance values:

NPO, C4xx dielectrics: E6, E12, E24 (see page 14). Specific values upon request.

X7R dielectric: E6, E12 in standard (see page 14). Specific values upon request.

The above table defines the standard products, other components may be built upon request.

Pulse capacitors with printed resistor option

CF / CFS Series



FEATURES

- Multilayer chip ceramic capacitors
- Size 1812 to 16080
- C4xx dielectric
- Capacitance range: 27pF to 15 μF
- Voltage range: 500 V_{DC} to 10,000 V_{DC}
- Option: Printed resistor

PHYSICAL CHARACTERISTICS

CONSTRUCTION

- C Series: Unleaded chip capacitors for surface mounting with optional tinning.
- P, PL, L, R, RU models: DIL or Ribbon led chip capacitors for surface mounting [R: varnished chips, RU: uncoated chips] recommended to eliminate thermomechanical stresses.
- N, NU models: DIL led chip capacitors for through-hole circuits [N: varnished chips, NU: uncoated chips].

ELECTRICAL SPECIFICATIONS

Dielectric	C4xx
Dielectric code	4
Temperature coefficient	(-2,200±500) ppm/°C
Aging	None
Operating temperature	-55°C to +125°C
Rated voltage (U _{RC})	500 V _{DC} to 10,000 V _{DC}
Dielectric withstanding voltage	1.1 U _{RC}
Capacitance	At 1kHz
Dissipation factor	≤ 0.10% at 1kHz
Insulation resistance at 25°C	≥ 20,000 MΩ for C ≤ 25nF under U _{RC} for U _{RC} ≤ 500V _{DC} ≥ 500 MΩ. μF for C > 25nF under 500V _{DC} for U _{RC} > 500V _{DC}

HIGH VOLTAGE

PRINTED RESISTOR OPTION

- Main values = 100 MΩ, 500 MΩ
- Other values possible, on request

HOW TO ORDER

CF	4	80	CW	-	M	F	220nF	10%	500V	S12	Rxxx
CFS	4	80	-	P	M	F	68nF	10%	1000V	-	Rxxx
Series	Dielectric	Exxelia size code	Termination (Bare chips only)	Leads style (Leaded chips/ Stacked capacitors)	Marking	Quality level	Capacitance	Tolerance	Rated voltage	Packaging	Printed resistor
CF = Pulse chips capacitor CFS = Pulse stacked capacitor	4 = C4xx	79 = 1812 90 = 1825 80 = 2220 91 = 2225 81 = 2825 82 = 3333 83 = 4040 84 = 5440 89 = 5550 85 = 6560 87 = 11283 88 = 16080	W = RoHS compliant For all sizes - Ag/Pd/Pt W Ag/Pd/Pt Q Ag QW Ag From 1812 to 3333 sizes E Ni* + dipped Sn/Pb 60/40 C + electrolytic Sn/Pb 95/5 Ni** + electrolytic Sn D Ag + Ni*** + electrolytic Sn/Pb 60/40 G Ni + electrolytic Gold From 1812 to 4040 sizes YC Ag + Polymer + Ni + Sn/Pb 95/5 YCW Ag + Polymer + Ni + Sn YD Ag + Polymer + Ni + Sn/Pb 60/40 YG Ag + Polymer + Ni + Au YGW Ag + Polymer + Ni + Au * Only 2225 to 3333 sizes ** Only 1812 to 2220 sizes (other sizes on demand) *** Only on demand	P PW - RoHS PL PLW - RoHS L LW - RoHS R RW - RoHS RU RUW - RoHS N NW - RoHS NU NUW - RoHS	Available on request. Non-resistor models only. - = no marking M = Marking: For sizes 1812 - 1825: Capa. value. For other sizes: Capa. value, Tolerance, Rated voltage, Date code.	- = standard quality level F = Hi-Rel quality: screening in accordance with Exxelia specification	Capacitance value in clear	±2% ±5% ±10% ±20%	500V 1,000V 1,500V 2,000V 3,000V 4,000V 5,000V 7,500V 10,000V	- = Exxelia packaging (leaded chips : thermoformed packaging) Only available for unleaded chips: Sizes 1812 - 2220: S12 = Super 12 reel BA = Tray package (non oriented chips) BAO = Tray package (oriented chips)	Rxxx = Printed resistor option [xxx = resistor value in MΩ]

CF Series

Pulse capacitors with printed resistor option

DIMENSIONS in inches (mm)

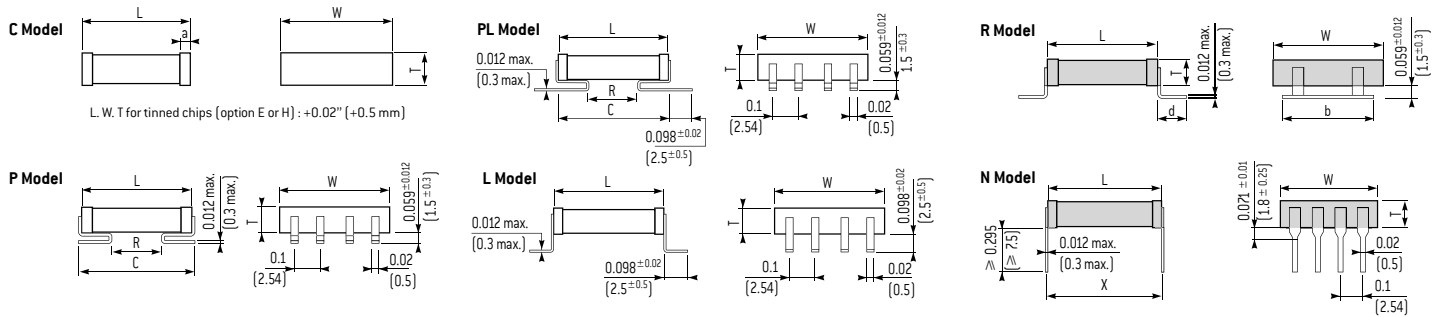

STANDARD RATINGS

Size	1812	1825	2220	2225	2825	3333	
Exxelia size code	79	90	80	91	81	82	
Dimensions inches (mm)	L*	0.177 ± 0.020 (4.5 ± 0.5)	0.177 ± 0.020 (4.5 ± 0.5)	0.224 ± 0.020 (5.7 ± 0.5)	0.224 ± 0.020 (5.7 ± 0.5)	0.276 ± 0.020 (7 ± 0.5)	0.331 ± 0.020 (8.4 ± 0.5)
	W*	0.126 ± 0.020 (3.2 ± 0.5)	0.250 ± 0.020 (6.35 ± 0.5)	0.197 ± 0.020 (5.0 ± 0.5)	0.250 ± 0.020 (6.35 ± 0.5)	0.250 ± 0.020 (6.35 ± 0.5)	0.331 ± 0.020 (8.4 ± 0.5)
	a	0.024 ± 0.020 (0.6 ± 0.5)	0.024 ± 0.020 (0.6 ± 0.5)	0.028 ± 0.020 (0.7 ± 0.5)	0.028 ± 0.020 (0.7 ± 0.5)	0.039 ± 0.020 (1 ± 0.5)	0.039 ± 0.020 (1 ± 0.5)
	d	-	0.087 ± 0.008 (2.2 ± 0.2)	0.087 ± 0.008 (2.2 ± 0.2)	0.087 ± 0.008 (2.2 ± 0.2)	0.087 ± 0.008 (2.2 ± 0.2)	0.138 ± 0.008 (3.5 ± 0.2)
	b	-	0.197 ± 0.020 (5 ± 0.5)	0.197 ± 0.020 (5 ± 0.5)	0.197 ± 0.020 (5 ± 0.5)	0.197 ± 0.020 (5 ± 0.5)	0.315 ± 0.020 (8 ± 0.5)
	R min.	-	0.066 (1.7)	0.098 (2.5)	0.098 (2.5)	0.137 (3.5)	0.177 (4.5)
	C max.	-	0.229 (5.8)	0.276 (7)	0.276 (7)	0.315 (8)	0.355 (9)
	X	-	0.2 ± 0.020 (5.08 ± 0.5)	0.248 ± 0.020 (6.3 ± 0.5)	0.248 ± 0.020 (6.3 ± 0.5)	0.300 ± 0.020 (7.62 ± 0.5)	0.350 ± 0.020 (8.9 ± 0.5)
	Leads per side	-	2	2	2	2	3
	T max.*	0.138 (3.5)	0.138 (3.5)	0.2kV up to 3kV: 0.119 [3] 4kV-5kV: 0.150 [3.8]	0.177 (4.5)	0.177 (4.5)	0.177 (4.5)
Min. Capacitance value	27pF	33pF	33pF	47pF	56pF	82pF	
Rated voltage (U _{RC})	0.5kV	120nF	330nF	220nF	390nF	390nF	820nF
	1kV	33nF	82nF	56nF	100nF	100nF	180nF
	1.5kV	15nF	33nF	27nF	39nF	47nF	82nF
	2kV	5.6nF	5.6nF	10nF	18nF	18nF	39nF
	3kV	2.2nF	2.7nF	4.2nF	8.2nF	8.2nF	18nF
	4kV	1.2nF	1.5nF	3.3nF	4.7nF	4.7nF	10nF
5kV	-	-	1.8nF	2.7nF	2.7nF	5.6nF	

Pulse capacitors with printed resistor option

CF Series

STANDARD RATINGS

Size	4040	5440	5550	6560	11283	16080	
Exxelia size code	83	84	89	85	87	88	
Dimensions inches (mm)	L*	0.400 ± 0.039 (10.16 ± 1)	0.539 ± 0.039 (13.7 ± 1)	0.551 ± 0.039 (14 ± 1)	0.650 ± 0.039 (16.5 ± 1)	1.122 ± 0.039 (28.5 ± 1)	1.555 ± 0.039 (39.5 ± 1)
	W*	0.400 ± 0.039 (10.16 ± 1)	0.400 ± 0.039 (10.16 ± 1)	0.500 ± 0.039 (12.7 ± 1)	0.598 ± 0.039 (15.2 ± 1)	0.827 ± 0.039 (21 ± 1)	0.756 ± 0.039 (19.2 ± 1)
	a	0.059 ± 0.020 (1.5 ± 0.5)	0.059 ± 0.020 (1.5 ± 0.5)	0.059 ± 0.020 (1.5 ± 0.5)	0.059 ± 0.020 (1.5 ± 0.5)	0.059 ± 0.020 (1.5 ± 0.5)	0.059 ± 0.020 (1.5 ± 0.5)
	d	0.138 ± 0.008 (3.5 ± 0.2)	0.138 ± 0.008 (3.5 ± 0.2)	0.138 ± 0.008 (3.5 ± 0.2)	0.138 ± 0.008 (3.5 ± 0.2)	0.138 ± 0.008 (3.5 ± 0.2)	0.138 ± 0.008 (3.5 ± 0.2)
	b	0.315 ± 0.020 (8 ± 0.5)	0.315 ± 0.020 (8 ± 0.5)	0.315 ± 0.020 (8 ± 0.5)	0.591 ± 0.020 (15 ± 0.5)	0.591 ± 0.020 (15 ± 0.5)	0.591 ± 0.020 (15 ± 0.5)
	R min.	0.275 (7)	0.393 (10)	0.393 (10)	0.511 (13)	0.984 (25)	1.377 (35)
	C max.	0.473 (12)	0.611 (15.5)	0.63 (16)	0.729 (18.5)	1.26 (32)	1.654 (42)
	X	0.45 ± 0.020 (11.43 ± 0.5)	0.551 ± 0.020 (14 ± 0.5)	0.563 ± 0.020 (14.3 ± 0.5)	0.7 ± 0.020 (17.78 ± 0.5)	1.15 ± 0.020 (29.21 ± 0.5)	1.6 ± 0.020 (40.64 ± 0.5)
	Leads per side	4	4	5	6	6	6
	T max.*	0.177 (4.5)	0.177 (4.5)	0.177 (4.5)	0.177 (4.5)	0.177 (4.5)	0.177 (4.5)
Min. Capacitance value	180pF	270pF	390pF	470pF	1nF	1.8nF	
Rated voltage (U _{ric})	0.5kV	1.2 µF	1.8 µF	2.2 µF	3.3 µF	8.2 µF	10 µF
	1kV	270nF	390nF	560nF	820nF	1.8 µF	2.2 µF
	1.5kV	120nF	180nF	270nF	390nF	820nF	1.2 µF
	2kV	68nF	100nF	150nF	220nF	470nF	680nF
	3kV	33nF	47nF	56nF	82nF	220nF	270nF
	4kV	18nF	27nF	27nF	47nF	120nF	150nF
	5kV	10nF	15nF	22nF	33nF	68nF	100nF
	7.5kV	4.7nF	4.7nF	4.7nF	10nF	33nF	47nF
	10kV	2.2nF	2.7nF	2.7nF	5.6nF	18nF	22nF

* For E, H and HW: add +0.020 inch (+0.5 mm) to L, W and T dimensions.
 The high voltage parts may require varnish or encapsulation to prevent surface arcing.
 Available capacitance values:
 C4xx dielectrics: E6, E12, E24. Specific values upon request.
 The above table defines the standard products, other components may be built upon request.

HIGH VOLTAGE

CFS Series

Pulse capacitors with printed resistor option

DIMENSIONS in inches (mm)

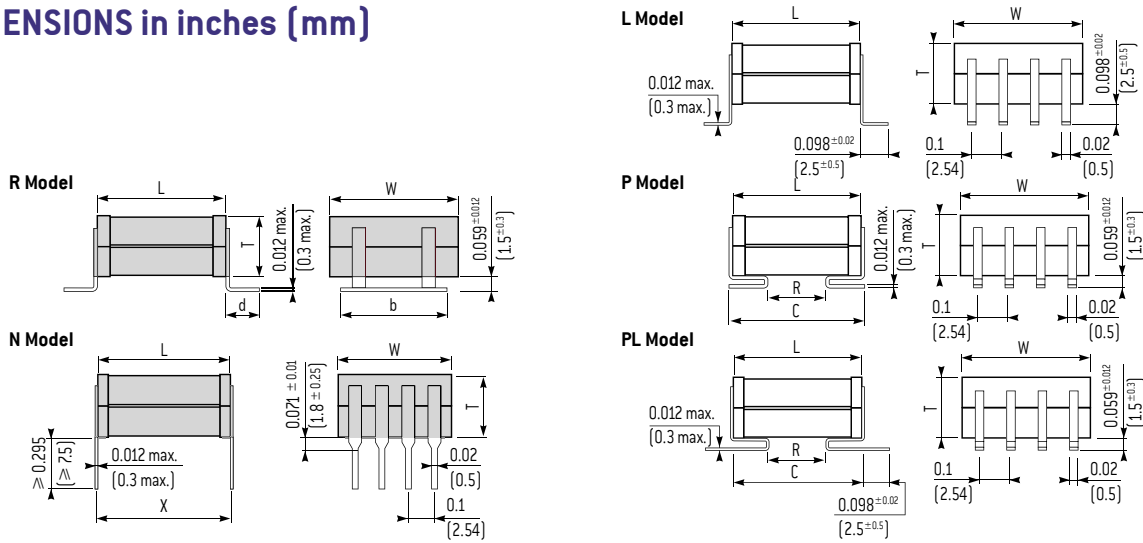

STANDARD RATINGS

	Size	2220	2825	3333	4040			
	Exxelia size code	80	81	82	83			
Dimensions inches (mm)	L	0.224 ± 0.020 (5.7 ± 0.5)	0.276 ± 0.020 (7 ± 0.5)	0.331 ± 0.020 (8.4 ± 0.5)	0.400 ± 0.039 (10.16 ± 1)			
	W	0.197 ± 0.020 (5.0 ± 0.5)	0.250 ± 0.020 (6.35 ± 0.5)	0.331 ± 0.020 (8.4 ± 0.5)	0.400 ± 0.039 (10.16 ± 1)			
	d	0.087 ± 0.008 (2.2 ± 0.2)	0.087 ± 0.008 (2.2 ± 0.2)	0.138 ± 0.008 (3.5 ± 0.2)	0.138 ± 0.008 (3.5 ± 0.2)			
	b	0.197 ± 0.020 (5 ± 0.5)	0.197 ± 0.020 (5 ± 0.5)	0.315 ± 0.020 (8 ± 0.5)	0.315 ± 0.020 (8 ± 0.5)			
	R min.	0.098 (2.5)	0.137 (3.5)	0.177 (4.5)	0.275 (7)			
	C max.	0.276 (7)	0.315 (8)	0.355 (9)	0.473 (12)			
	X	0.248 ± 0.020 (6.3 ± 0.5)	0.300 ± 0.020 (7.62 ± 0.5)	0.350 ± 0.020 (8.9 ± 0.5)	0.45 ± 0.020 (11.43 ± 0.5)			
	Leads per side	2	2	3	4			
Rated voltage (U _{DC})	Min. Capacitance value	820pF	1.5nF	2.7nF	6.8nF	T max.	Nb. of chips	
						inches (mm)		
	1kV	68nF	150nF	390nF	680nF	0.394	(10)	2
		100nF	220nF	560nF	1 μF	0.591	(15)	3
		150nF	270nF	680nF	1.2 μF	0.788	(20)	4
		180nF	390nF	1 μF	1.5 μF	0.985	(25)	5
	1.5kV	33nF	68nF	180nF	270nF	0.394	(10)	2
		47nF	100nF	270nF	390nF	0.591	(15)	3
		68nF	120nF	330nF	560nF	0.788	(20)	4
		82nF	150nF	390nF	680nF	0.985	(25)	5
	2kV	18nF	39nF	68nF	120nF	0.394	(10)	2
		27nF	56nF	100nF	180nF	0.591	(15)	3
		39nF	68nF	150nF	220nF	0.788	(20)	4
		47nF	82nF	180nF	330nF	0.985	(25)	5
	3kV		15nF	33nF	56nF	0.394	(10)	2
			22nF	47nF	82nF	0.591	(15)	3
			33nF	68nF	120nF	0.788	(20)	4
			39nF	82nF	150nF	0.985	(25)	5
	4kV				39nF	0.394	(10)	2
					68nF	0.591	(15)	3
					82nF	0.788	(20)	4
					100nF	0.985	(25)	5
	5kV		Consult us	Consult us		0.394	(10)	2
						0.591	(15)	3
						0.788	(20)	4
						0.985	(25)	5
	7.5kV 10kV				Consult us	0.394	(10)	2
						0.591	(15)	3
					0.788	(20)	4	
					0.985	(25)	5	

Pulse capacitors with printed resistor option

CFS Series

STANDARD RATINGS

Size	5440	5550	6560	11283	16080				
Exxelia size code	84	89	85	87	88				
Dimensions inches (mm)	L	0.539 ± 0.039 (13.7 ± 1)	0.551 ± 0.039 (14 ± 1)	0.650 ± 0.039 (16.5 ± 1)	1.122 ± 0.039 (28.5 ± 1)	1.555 ± 0.039 (39.5 ± 1)			
	W	0.400 ± 0.039 (10.16 ± 1)	0.500 ± 0.039 (12.7 ± 1)	0.598 ± 0.039 (15.2 ± 1)	0.827 ± 0.039 (21 ± 1)	0.756 ± 0.039 (19.2 ± 1)			
	d	0.138 ± 0.008 (3.5 ± 0.2)	0.138 ± 0.008 (3.5 ± 0.2)	0.138 ± 0.008 (3.5 ± 0.2)	0.138 ± 0.008 (3.5 ± 0.2)	0.138 ± 0.008 (3.5 ± 0.2)			
	b	0.315 ± 0.020 (8 ± 0.5)	0.315 ± 0.020 (8 ± 0.5)	0.591 ± 0.020 (15 ± 0.5)	0.591 ± 0.020 (15 ± 0.5)	0.591 ± 0.020 (15 ± 0.5)			
	R min.	0.393 (10)	0.393 (10)	0.511 (13)	0.984 (25)	1.377 (35)			
	C max.	0.611 (15.5)	0.63 (16)	0.729 (18.5)	1.26 (32)	1.654 (42)			
	X	0.552 ± 0.020 (14 ± 0.5)	0.563 ± 0.020 (14.3 ± 0.5)	0.7 ± 0.020 (17.78 ± 0.5)	1.15 ± 0.020 (29.21 ± 0.5)	1.6 ± 0.020 (40.64 ± 0.5)			
Leads per side	4	5	6	6	6				
Min Capacitance value	6.8nF	12nF	18nF	39nF	47nF	T max.		Nb. of	
Rated voltage (U _{rec})	1kV	820nF	1.0 µF	1.8 µF	3.9 µF	5.6 µF	0.394	(10)	2
		1.2 µF	1.5 µF	2.7 µF	5.6 µF	8.2 µF	0.591	(15)	3
		1.8 µF	2.2 µF	3.3 µF	8.2 µF	10 µF	0.788	(20)	4
		2.2 µF	2.7 µF	4.7 µF	10 µF	12 µF	0.985	(25)	5
	1.5kV	390nF	470nF	820nF	1.8 µF	2.2 µF	0.394	(10)	2
		560nF	680nF	1.2 µF	2.7 µF	3.3 µF	0.591	(15)	3
		820nF	1 µF	1.5 µF	3.9 µF	4.7 µF	0.788	(20)	4
		1 µF	1.2 µF	1.8 µF	4.7 µF	5.6 µF	0.985	(25)	5
	2kV	180nF	270nF	390nF	1 µF	1.2 µF	0.394	(10)	2
		270nF	330nF	560nF	1.5 µF	1.8 µF	0.591	(15)	3
		390nF	470nF	820nF	1.8 µF	2.7 µF	0.788	(20)	4
		470nF	560nF	1 µF	2.2 µF	3.3 µF	0.985	(25)	5
	3kV	82nF	100nF	180nF	390nF	560nF	0.394	(10)	2
		120nF	150nF	270nF	680nF	820nF	0.591	(15)	3
		150nF	180nF	330nF	820nF	1.2 µF	0.788	(20)	4
		220nF	220nF	470nF	1 µF	1.5 µF	0.985	(25)	5
	4kV	56nF	68nF	100nF	220nF	330nF	0.394	(10)	2
		100nF	100nF	150nF	330nF	470nF	0.591	(15)	3
		120nF	120nF	220nF	470nF	680nF	0.788	(20)	4
		150nF	150nF	270nF	560nF	820nF	0.985	(25)	5
	5kV	33nF	39nF	68nF	150nF	220nF	0.394	(10)	2
		56nF	56nF	100nF	220nF	330nF	0.591	(15)	3
		68nF	82nF	120nF	270nF	390nF	0.788	(20)	4
		82nF	100nF	150nF	390nF	560nF	0.985	(25)	5
	7.5kV	10nF	10nF	22nF	68nF	82nF	0.394	(10)	2
		15nF	15nF	33nF	100nF	120nF	0.591	(15)	3
		18nF	22nF	39nF	120nF	180nF	0.788	(20)	4
		27nF	27nF	56nF	150nF	220nF	0.985	(25)	5
10kV	5.6nF	5.6nF	12nF	33nF	47nF	0.394	(10)	2	
	6.8nF	8.2nF	18nF	47nF	68nF	0.591	(15)	3	
	10nF	12nF	22nF	68nF	100nF	0.788	(20)	4	
	12nF	15nF	27nF	82nF	120nF	0.985	(25)	5	

HIGH VOLTAGE

The high voltage parts may require varnish or encapsulation to prevent surface arcing.

Available capacitance values:

C4xx dielectrics: E6, E12, E24. Specific values upon request.

The above table defines the standard products, other components may be built upon request.

CS Series

High Voltage Stacked Capacitors



FEATURES

- Multilayer chip ceramic capacitors stacked
- NPO, C4xx and X7R dielectrics
- Capacitance range: 220pf to 15 μ F
- Voltage range: 1,000 V_{DC} to 10,000 V_{DC}

PHYSICAL CHARACTERISTICS

CONSTRUCTION

- **P, PL, L models:** DIL leaded uncoated stacked chip capacitors for surface mounting recommended to eliminate thermomechanical stresses.
- **N, NU models:** DIL leaded stacked chip capacitors for through-hole circuits (N: varnished chips, NU: uncoated chips).
- **R, RU models:** Ribbon leaded stacked chip capacitors for surface mounting (R: varnished chips, RU: uncoated chips) recommended to eliminate thermomechanical stresses.

RECOMMENDED FOOTPRINT

See general information on high voltage capacitors (see page 50).

MARKING

Series, capacitance value, tolerance, rated voltage, date code.

ELECTRICAL SPECIFICATIONS

DIELECTRIC	NPO	C4xx	X7R
Dielectric code	1	4	2
Maximum $\Delta C/^\circ C$ over temperature range without voltage	NA	NA	$\pm 15\%$
Temperature coefficient	$[0\pm 30]$ ppm/ $^\circ C$	$[-2,200\pm 500]$ ppm/ $^\circ C$	NA
Aging	None	None	$\leq 2.5\%$ per decade hour
Operating temperature	$-55^\circ C$ to $+125^\circ C$		
Rated voltage (U_{RC})	1,000 V_{DC} to 10,000 V_{DC}	1,000 V_{DC} to 5,000 V_{DC}	1,000 V_{DC} to 10,000 V_{DC}
Dielectric withstanding voltage	1.3 U_{RC}	1.2 U_{RC}	1.2 U_{RC}
Capacitance	at 1MHz for $C \leq 1,000$ pf at 1kHz for $C > 1,000$ pf	at 1kHz	at 1kHz
Dissipation factor	$\leq 0.15\%$ at 1MHz for $C \leq 1,000$ pf $\leq 0.15\%$ at 1kHz for $C > 1,000$ pf	$\leq 0.10\%$ at 1kHz	$\leq 2.5\%$ at 1kHz
Insulation resistance at 25 $^\circ C$ under U_{RC} for $U_{RC} \leq 500$ V under 500 V_{DC} for $U_{RC} > 500$ V	$\geq 100,000$ M Ω for $C \leq 10$ nf $\geq 1,000$ M $\Omega \cdot \mu F$ for $C > 10$ nf	$\geq 20,000$ M Ω for $C \leq 25$ nf ≥ 500 M $\Omega \cdot \mu F$ for $C > 25$ nf	

HOW TO ORDER

CS	2	84	P	W	F	120nF	20%	2,000 V	-
Series	Dielectric code	Exxelia size code	Leads style	RoHS compliant	Quality level	Capacitance	Tolerance	Rated voltage	Reliability level
CS = High voltage stacked capacitor	1 = NPO 2 = X7R 4 = C4xx	80 81 82 83 84 89 85 87 88	P PL L R RU N NU	- = No RoHS W = RoHS compliant	- = standard quality level F = Hi-Rel quality: screening in accordance with Exxelia specification	Capacitance value in clear	NPO dielectric: $\pm 1\%$ $\pm 2\%$ $\pm 5\%$ $\pm 10\%$ $\pm 20\%$ C4xx dielectric: $\pm 2\%$ $\pm 5\%$ $\pm 10\%$ $\pm 20\%$ X7R dielectric: $\pm 10\%$ $\pm 20\%$	1,000 V 1,500 V 2,000 V 3,000 V 4,000 V 5,000 V 7,500 V 10,000 V Intermediary, lower and higher voltages available: contact your sales representative.	For F parts only. Acc. to Exxelia spec. - T5 T6 See page 15

High Voltage Stacked Capacitors

CS Series

DIMENSIONS in inches (mm)

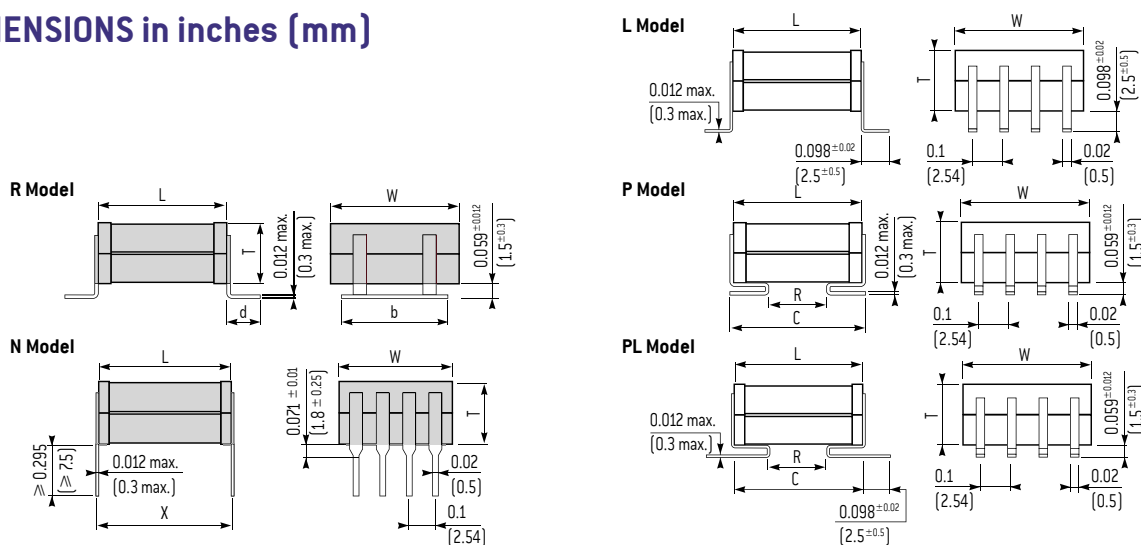

STANDARD RATINGS

	Size		2220		2825		3333		4040								
	Exxelia size code		80	81	82	83											
Dimensions inches (mm)	L		0.224 ± 0.020 (5.7 ± 0.5)	0.276 ± 0.020 (7 ± 0.5)	0.331 ± 0.020 (8.4 ± 0.5)	0.400 ± 0.039 (10.16 ± 1)											
	W		0.197 ± 0.020 (5.0 ± 0.5)	0.250 ± 0.020 (6.35 ± 0.5)	0.331 ± 0.020 (8.4 ± 0.5)	0.400 ± 0.039 (10.16 ± 1)											
	d		0.087 ± 0.008 (2.2 ± 0.2)	0.087 ± 0.008 (2.2 ± 0.2)	0.138 ± 0.008 (3.5 ± 0.2)	0.138 ± 0.008 (3.5 ± 0.2)											
	b		0.197 ± 0.020 (5 ± 0.5)	0.197 ± 0.020 (5 ± 0.5)	0.315 ± 0.020 (8 ± 0.5)	0.315 ± 0.020 (8 ± 0.5)											
	R min.		0.098 (2.5)	0.137 (3.5)	0.177 (4.5)	0.275 (7)											
	C max.		0.276 (7)	0.315 (8)	0.355 (9)	0.473 (12)											
	X		0.248 ± 0.020 (6.3 ± 0.5)	0.300 ± 0.020 (7.62 ± 0.5)	0.350 ± 0.020 (8.9 ± 0.5)	0.45 ± 0.020 (11.43 ± 0.5)											
	Leads per side		2	2	3	4											
Rated voltage (U _{dic})	Dielectric		NPO	C4xx	X7R	NPO	C4xx	X7R	NPO	C4xx	X7R	NPO	C4xx	X7R	T max. inches (mm)	Nb. of chips	
	Exxelia ceramic code		1	4	2	1	4	2	1	4	2	1	4	2			
	Min. Capacitance value		1nF	3.9nF	12nF	1nF	3.3nF	12nF	1.8nF	5.6nF	22nF	220pF	10nF	27nF			
	1kV			12nF	39nF	100nF	18nF	56nF	180nF	39nF	100nF	270nF	68nF	220nF	560nF	0.394 (10)	2
				18nF	68nF	150nF	27nF	82nF	270nF	56nF	150nF	390nF	100nF	330nF	1µF	0.591 (15)	3
				-	-	-	-	-	-	-	-	-	-	-	-	0.788 (20)	4
	1.5kV			5.6nF	18nF	39nF	8.2nF	27nF	68nF	22nF	56nF	120nF	39nF	100nF	270nF	0.394 (10)	2
				8.2nF	27nF	56nF	12nF	39nF	100nF	33nF	68nF	180nF	56nF	150nF	390nF	0.591 (15)	3
				-	-	-	-	-	-	-	-	-	-	-	-	0.788 (20)	4
	2kV			3.3nF	10nF	22nF	4.7nF	18nF	39nF	8.2nF	27nF	68nF	18nF	56nF	150nF	0.394 (10)	2
				4.7nF	15nF	33nF	6.8nF	27nF	68nF	12nF	39nF	120nF	27nF	82nF	220nF	0.591 (15)	3
				-	-	-	-	-	-	-	-	-	-	-	-	0.788 (20)	4
	3kV			2.2nF	4.7nF	12nF	2.7nF	6.8nF	18nF	4.7nF	12nF	33nF	10nF	27nF	68nF	0.394 (10)	2
				3.3nF	6.8nF	18nF	3.9nF	10nF	27nF	6.8nF	22nF	47nF	15nF	39nF	100nF	0.591 (15)	3
				-	-	-	-	-	-	-	-	-	-	-	-	0.788 (20)	4
	4kV			1nF	2.7nF	5.6nF	1.8nF	3.3nF	12nF	3.3nF	6.8nF	22nF	5.6nF	15nF	39nF	0.394 (10)	2
				1.5nF	3.9nF	8.2nF	2.7nF	4.7nF	18nF	4.7nF	10nF	33nF	8.2nF	22nF	56nF	0.591 (15)	3
				-	-	-	-	-	-	-	-	-	-	-	-	0.788 (20)	4
	5kV			560pF	1.5nF	3.9nF	1.2nF	2.2nF	8.2nF	2.2nF	3.9nF	12nF	3.9nF	8.2nF	27nF	0.394 (10)	2
				820pF	2.7nF	5.6nF	1.8nF	3.3nF	12nF	3.3nF	5.6nF	18nF	5.6nF	12nF	39nF	0.591 (15)	3
				-	-	-	-	-	-	-	-	-	-	-	-	0.788 (20)	4
	7.5kV			-	-	-	-	-	-	-	-	-	820pF	-	8.2nF	0.394 (10)	2
				-	-	-	-	-	-	-	-	-	1.2nF	-	12nF	0.591 (15)	3
				-	-	-	-	-	-	-	-	-	-	-	-	0.788 (20)	4
	10kV			-	-	-	-	-	-	-	-	-	560pF	-	4.7nF	0.394 (10)	2
				-	-	-	-	-	-	-	-	-	820pF	-	6.8nF	0.591 (15)	3
				-	-	-	-	-	-	-	-	-	-	-	-	0.788 (20)	4
		Due to flashover risks, please consult us for these capacitance values.											0.985 (25)	5			

HIGH VOLTAGE

STANDARD RATINGS

Size	5440			5550			6560			11283			16080						
Exxelia size code	84			89			85			87			88						
Dimensions inches (mm)	L	0.539 ± 0.039 (13.7 ± 1)			0.551 ± 0.039 (14 ± 1)			0.650 ± 0.039 (16.5 ± 1)			1.122 ± 0.039 (28.5 ± 1)			1.555 ± 0.039 (39.5 ± 1)					
	W	0.400 ± 0.039 (10.16 ± 1)			0.500 ± 0.039 (12.7 ± 1)			0.598 ± 0.039 (15.2 ± 1)			0.827 ± 0.039 (21 ± 1)			0.756 ± 0.039 (19.2 ± 1)					
	d	0.138 ± 0.008 (3.5 ± 0.2)			0.138 ± 0.008 (3.5 ± 0.2)			0.138 ± 0.008 (3.5 ± 0.2)			0.138 ± 0.008 (3.5 ± 0.2)			0.138 ± 0.008 (3.5 ± 0.2)					
	b	0.315 ± 0.020 (8 ± 0.5)			0.315 ± 0.020 (8 ± 0.5)			0.591 ± 0.020 (15 ± 0.5)			0.591 ± 0.020 (15 ± 0.5)			0.591 ± 0.020 (15 ± 0.5)					
	R min.	0.393 (10)			0.393 (10)			0.511 (13)			0.984 (25)			1.377 (35)					
	C max.	0.611 (15.5)			0.63 (16)			0.729 (18.5)			1.26 (32)			1.654 (42)					
	X	0.552 ± 0.020 (14 ± 0.5)			0.563 ± 0.020 (14.3 ± 0.5)			0.7 ± 0.020 (17.78 ± 0.5)			1.15 ± 0.020 (29.21 ± 0.5)			1.6 ± 0.020 (40.64 ± 0.5)					
Leads per side	4			5			6			6			6						
Dielectric	NPO	C4xx	X7R	NPO	C4xx	X7R	NPO	C4xx	X7R	NPO	C4xx	X7R	NPO	C4xx	X7R	T max. inches (mm)	Nb. of chips		
Exxelia ceramic code	1	4	2	1	4	2	1	4	2	1	4	2	1	4	2				
Min Capacitance value	3.9nF	6.8nF	22nF	4.7nF	12nF	27nF	6.8nF	18nF	39nF	2.2nF	39nF	15nF	3.3nF	47nF	27nF				
Rated voltage (U _{rated})	1kV	100nF	270nF	820nF	120nF	390nF	1µF	220nF	560nF	1.8µF	470nF	1.5µF	3.9µF	560nF	1.8µF	5.6µF	0.394	(10)	2
		150nF	390nF	1.2µF	180nF	560nF	1.5µF	330nF	820nF	2.7µF	680nF	2.2µF	5.6µF	820nF	2.2µF	8.2µF	0.591	(15)	3
		220nF	560nF	1.8µF	270nF	820nF	2.2µF	470nF	1.2µF	3.3µF	1µF	3.3µF	6.8µF	1.2µF	3.9µF	10µF	0.788	(20)	4
		-	-	-	330nF	1µF	2.7µF	560nF	1.5µF	3.9µF	1.2µF	3.9µF	10µF	1.5µF	4.7µF	15µF	0.985	(25)	5
	1.5kV	47nF	120nF	390nF	68nF	180nF	470nF	100nF	270nF	680nF	270nF	680nF	1.5µF	330nF	820nF	2.2µF	0.394	(10)	2
		68nF	180nF	560nF	100nF	270nF	680nF	150nF	390nF	1µF	390nF	1µF	2.2µF	470nF	1.2µF	3.3µF	0.591	(15)	3
		100nF	270nF	820nF	150nF	390nF	1µF	220nF	560nF	1.5µF	560nF	1.5µF	2.7µF	680nF	1.8µF	4.7µF	0.788	(20)	4
		-	-	-	180nF	470nF	1.2µF	270nF	680nF	1.8µF	680nF	1.8µF	3.9µF	820nF	2.2µF	5.6µF	0.985	(25)	5
	2kV	27nF	68nF	220nF	33nF	100nF	270nF	47nF	150nF	390nF	82nF	390nF	1µF	120nF	470nF	1.2µF	0.394	(10)	2
		39nF	100nF	330nF	47nF	150nF	390nF	68nF	220nF	560nF	120nF	560nF	1.5µF	180nF	680nF	1.8µF	0.591	(15)	3
		56nF	150nF	470nF	68nF	220nF	560nF	100nF	270nF	820nF	180nF	820nF	1.8µF	270nF	1µF	2.7µF	0.788	(20)	4
		-	-	-	82nF	270nF	680nF	120nF	390nF	1µF	220nF	1µF	2.7µF	330nF	1.2µF	3.3µF	0.985	(25)	5
	3kV	15nF	27nF	100nF	22nF	47nF	120nF	27nF	68nF	180nF	56nF	180nF	390nF	82nF	220nF	560nF	0.394	(10)	2
		22nF	39nF	150nF	33nF	68nF	180nF	39nF	100nF	270nF	82nF	270nF	680nF	120nF	330nF	820nF	0.591	(15)	3
		27nF	56nF	220nF	47nF	100nF	270nF	56nF	150nF	390nF	120nF	390nF	820nF	180nF	470nF	1.2µF	0.788	(20)	4
		-	-	-	56nF	120nF	330nF	68nF	180nF	470nF	150nF	470nF	1.2µF	220nF	560nF	1.5µF	0.985	(25)	5
	4kV	8.2nF	15nF	56nF	10nF	33nF	82nF	18nF	39nF	120nF	33nF	82nF	220nF	47nF	120nF	330nF	0.394	(10)	2
		12nF	22nF	82nF	15nF	47nF	120nF	27nF	56nF	180nF	47nF	120nF	330nF	68nF	180nF	470nF	0.591	(15)	3
		18nF	27nF	120nF	22nF	68nF	180nF	39nF	82nF	270nF	68nF	180nF	470nF	100nF	270nF	680nF	0.788	(20)	4
		-	-	-	27nF	82nF	220nF	47nF	100nF	330nF	82nF	220nF	560nF	120nF	330nF	820nF	0.985	(25)	5
	5kV	5.6nF	8.2nF	39nF	6.8nF	18nF	47nF	12nF	22nF	68nF	22nF	56nF	150nF	33nF	68nF	180nF	0.394	(10)	2
		8.2nF	12nF	56nF	10nF	27nF	68nF	18nF	33nF	100nF	33nF	82nF	180nF	47nF	100nF	270nF	0.591	(15)	3
		12nF	18nF	82nF	15nF	39nF	100nF	27nF	47nF	150nF	47nF	120nF	270nF	68nF	150nF	390nF	0.788	(20)	4
		-	-	-	18nF	47nF	120nF	33nF	56nF	180nF	56nF	150nF	330nF	82nF	180nF	470nF	0.985	(25)	5
	7.5kV	1nF	-	12nF	1.5nF	-	15nF	2.2nF	-	22nF	5.6nF	-	56nF	8.2nF	-	82nF	0.394	(10)	2
		1.5nF	-	18nF	2.2nF	-	22nF	3.3nF	-	33nF	8.2nF	-	82nF	12nF	-	120nF	0.591	(15)	3
		2.2nF	-	27nF	2.7nF	-	27nF	4.7nF	-	47nF	12nF	-	120nF	18nF	-	180nF	0.788	(20)	4
		-	-	-	3.9nF	-	39nF	5.6nF	-	56nF	15nF	-	150nF	22nF	-	220nF	0.985	(25)	5
10kV	680pF	-	5.6nF	1nF	-	6.8nF	1.5nF	-	12nF	3.9nF	-	27nF	5.6nF	-	39nF	0.394	(10)	2	
	1nF	-	8.2nF	1.5nF	-	10nF	2.2nF	-	18nF	5.6nF	-	39nF	8.2nF	-	56nF	0.591	(15)	3	
	1.5nF	-	12nF	2.2nF	-	15nF	2.7nF	-	27nF	8.2nF	-	56nF	12nF	-	82nF	0.788	(20)	4	
	-	-	-	2.7nF	-	18nF	3.9nF	-	33nF	10nF	-	68nF	15nF	-	100nF	0.985	(25)	5	

The high voltage parts may require varnish or encapsulation to prevent surface arcing.

Available capacitance values:

NPO, C4xx dielectrics: E6, E12, E24 (see page 14). Specific values upon request.

X7R dielectric: E6, E12 in standard (see page 14). Specific values upon request.

The above table defines the standard products, other components may be built upon request.

Due to flashover risks, please consult us for these capacitance values.

HIGH CAPACITANCE

GENERAL INFORMATION 74

R SERIES (CHIPS)

High Capacitance Chips Capacitors 79

R SERIES (LEADED)

Radial leaded Conformal Coated Capacitors 83

TEF SERIES

Radial leaded Conformal Coated Capacitors 86

SC / SV SERIES

High Capacitance Stacked Capacitors 87

CNC3X SERIES

High Capacitance Stacked Capacitors 94

CEC5X SERIES

High Capacitance Stacked Capacitors 96

TEP / TEV SERIES

High Capacitance Stacked Capacitors 99

TCN8X SERIES

High Capacitance Molded Stacked Capacitors 101



General Information

These capacitors have been developed in response to demand from switched mode power supply (S.M.P.S.) and DC-DC converters manufacturers. They are particularly suitable for filtering, smoothing and decoupling purpose in Hi-Rel equipments. The capacitors utilize advanced ceramic technology to achieve Hi-Rel long operating life and small size. They are designed for hybrid assemblies and low profile printed circuit applications.

Customized assemblies may be achieved with standard bare chip sizes mentioned in the following chapters.

TYPICAL CURVES: R Series, SC/SV Series

X DIELECTRIC: TYPICAL VOLTAGE COEFFICIENT AT 25°C (FOR ALL SIZES)

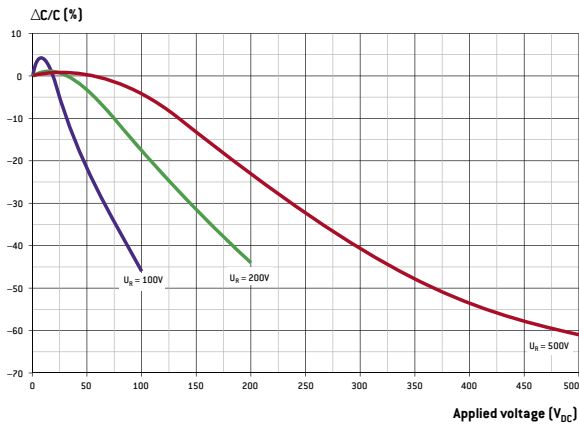

T DIELECTRIC: TYPICAL VOLTAGE COEFFICIENT AT 25°C (for all sizes)

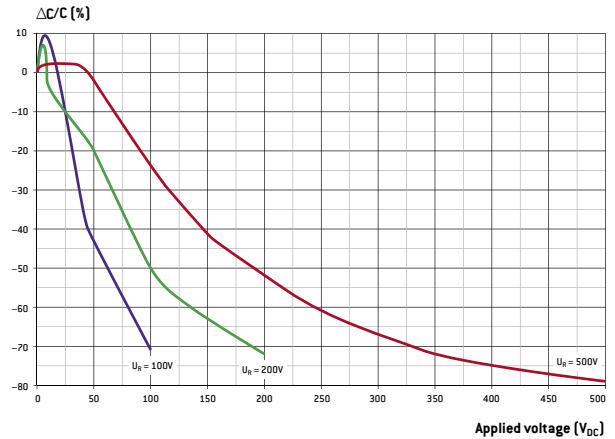

X DIELECTRIC: TYPICAL TEMPERATURE COEFFICIENT WITHOUT VOLTAGE (for all sizes)

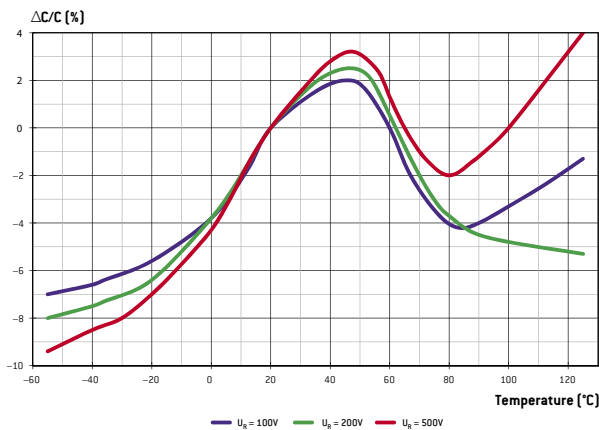

T DIELECTRIC: TYPICAL TEMPERATURE COEFFICIENT WITHOUT VOLTAGE (for all sizes)

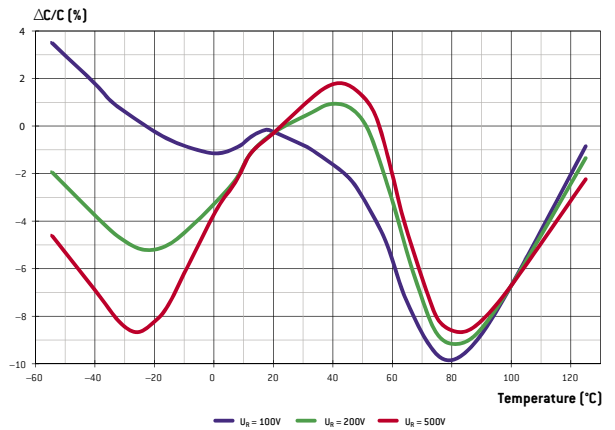

General Information

TYPICAL CURVES: R Series, SC/SV Series

TYPICAL ESR VS FREQUENCY

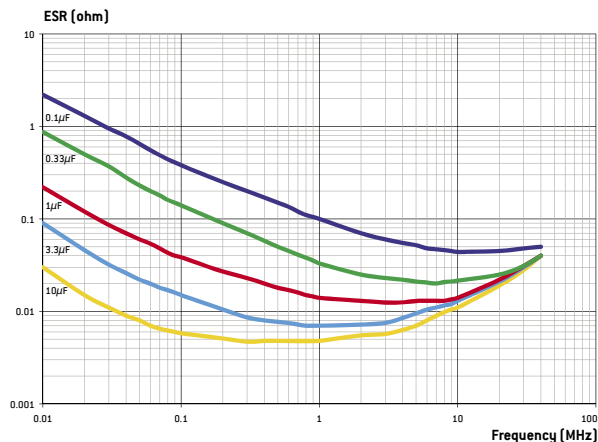

The ESR (Equivalent Serial Resistance) curves are given here for SMD (chips all case sizes) capacitors. Regarding the curves for the leaded capacitors, they are rather the same. Indeed, due to the resistivity of the raw material used and the wire diameters, the resistance of the wires is much lower than the ESR of the chips. So, in a first approach, their influence can be considered as negligible.

TYPICAL ESR VS FREQUENCY

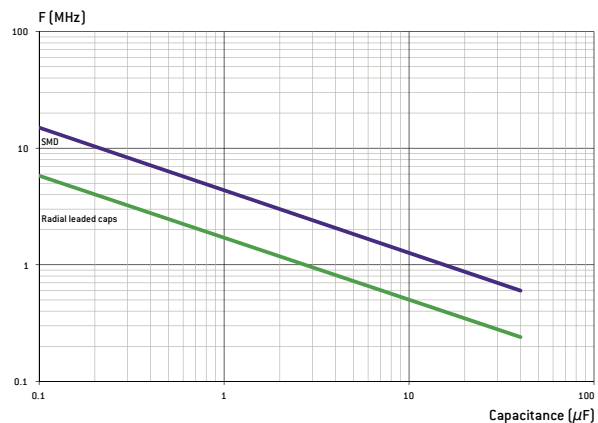

TYPICAL MAXIMUM ADMISSIBLE CURRENT VS FREQUENCY

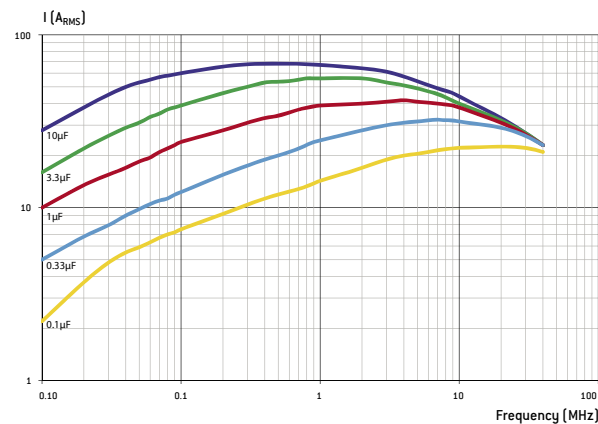

These typical curves are an example of admissible currents for one family of chip capacitors: 501R3740X chip series. For other curves and products or for further information, please contact us. Note: for the calculations, we have considered that the terminations are directly connected to an infinite heat sink. In other words, the thermal resistance of the circuit itself which depends of its type and design has not been taken into account. Moreover, the ambient temperature taken is 25°C.

HIGH CAPACITANCE

General Information

TYPICAL CURVES: CNC3X Series

TYPICAL TEMPERATURE COEFFICIENT

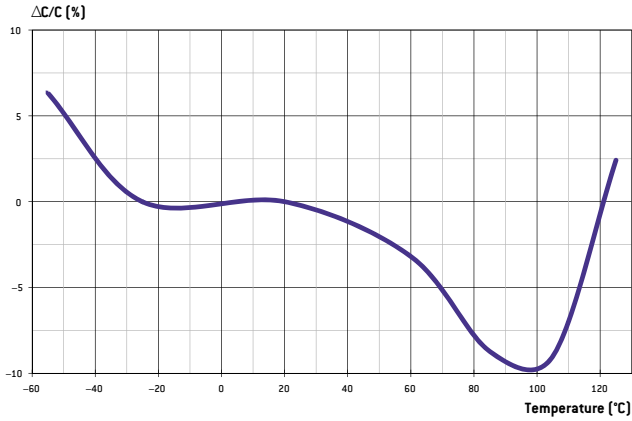

TYPICAL VOLTAGE COEFFICIENT

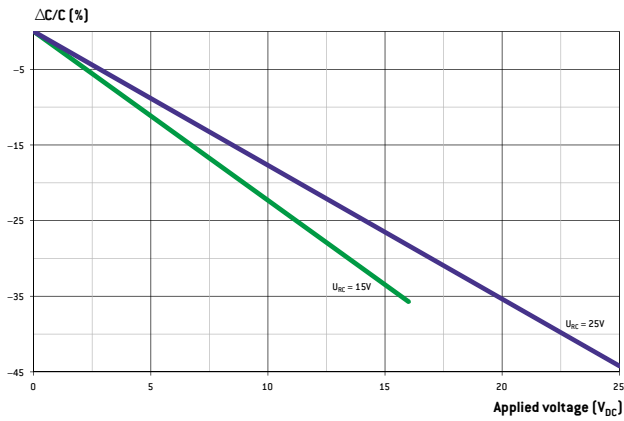

MAXIMUM CURRENT VS FREQUENCY

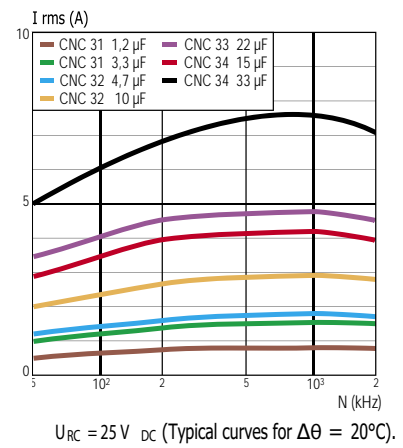
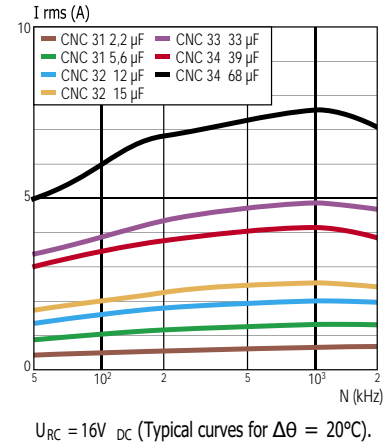

General Information

TYPICAL CURVES: CEC5X Series

NPO: CURRENT VS FREQUENCY

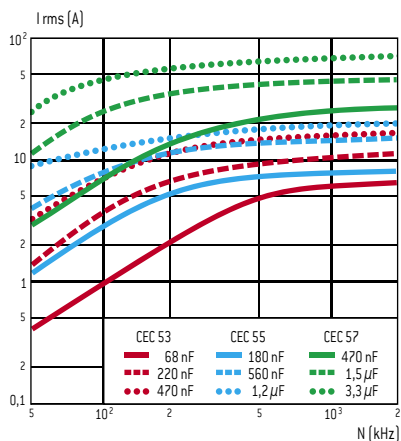

$U_{RC} = 63 V_{DC}$ (Typical curve for $\Delta\theta = 20^\circ C$).

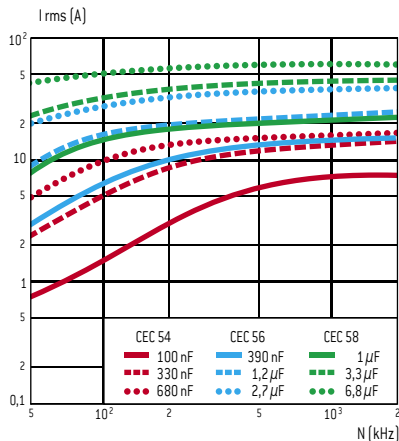

$U_{RC} = 63 V_{DC}$ (Typical curve for $\Delta\theta = 20^\circ C$).

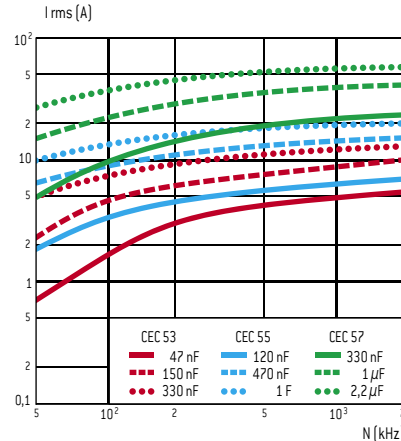

$U_{RC} = 100 V_{DC}$ (Typical curve for $\Delta\theta = 20^\circ C$).

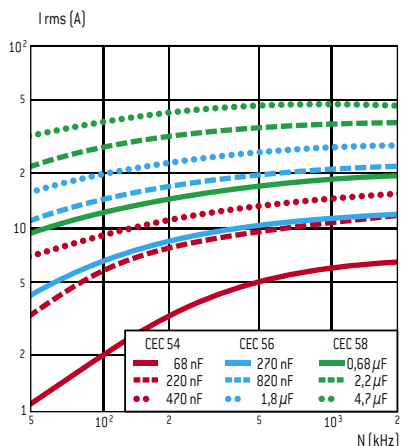

$U_{RC} = 100 V_{DC}$ (Typical curve for $\Delta\theta = 20^\circ C$).

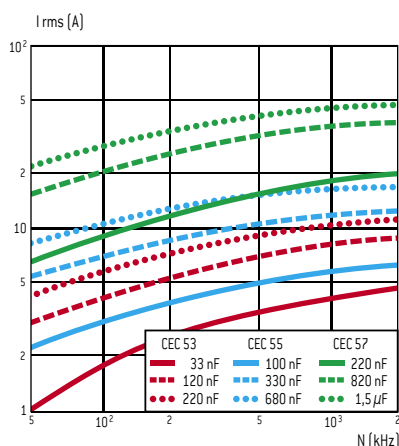

$U_{RC} = 200 V_{DC}$ (Typical curve for $\Delta\theta = 20^\circ C$).

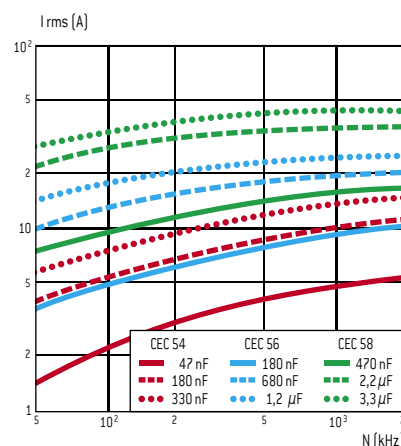

$U_{RC} = 200 V_{DC}$ (Typical curve for $\Delta\theta = 20^\circ C$).

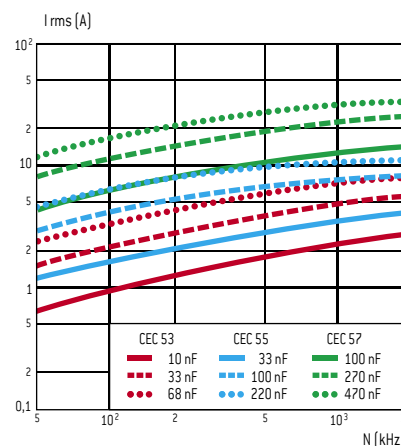

$U_{RC} = 500 V_{DC}$ (Typical curve for $\Delta\theta = 20^\circ C$).

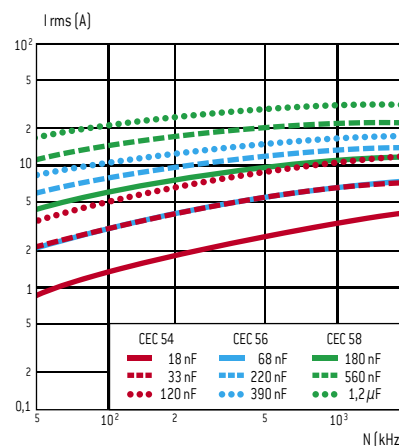

$U_{RC} = 500 V_{DC}$ (Typical curve for $\Delta\theta = 20^\circ C$).

HIGH CAPACITANCE

General Information

TYPICAL CURVES: TCN8X Series

TCN83: TYPICAL EQUIVALENT SERIAL RESISTANCE (ESR) VS FREQUENCY (N)

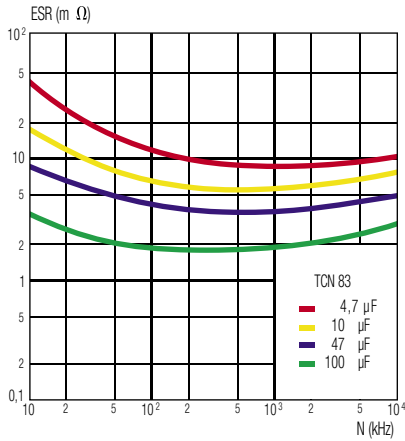

TCN86: TYPICAL EQUIVALENT SERIAL RESISTANCE (ESR) VS FREQUENCY (N)

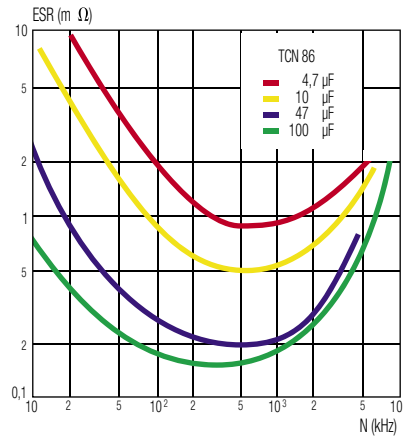

TCN87: TYPICAL EQUIVALENT SERIAL RESISTANCE (ESR) VS FREQUENCY (N)

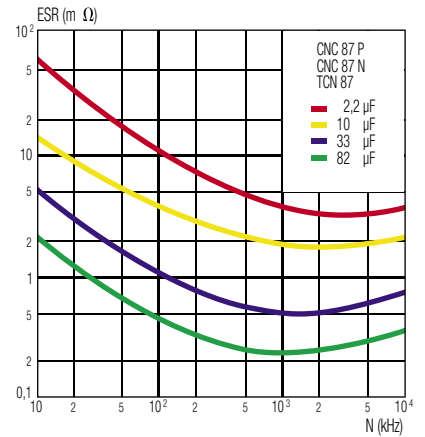

TCN83: CURRENT (I_{RMS}) VS FREQUENCY (N) TYPICAL CURVES FOR Δθ ≤ 20°C

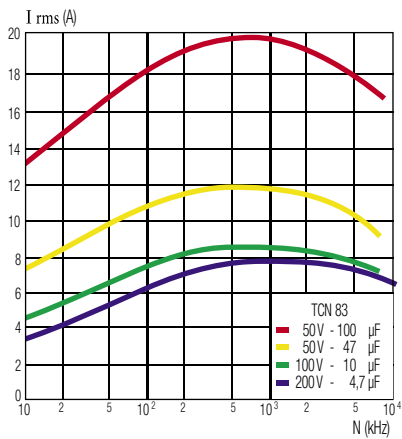

TCN86: CURRENT (I_{RMS}) VS FREQUENCY (N) TYPICAL CURVES FOR Δθ ≤ 20°C

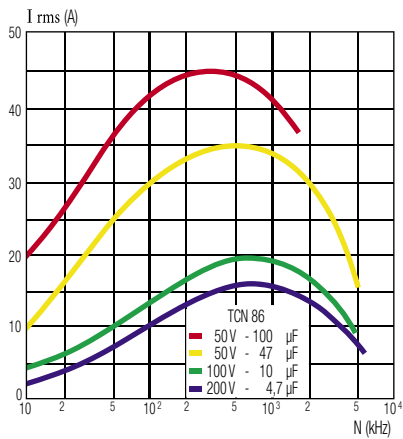

TCN87: CURRENT (I_{RMS}) VS FREQUENCY (N) TYPICAL CURVES FOR Δθ ≤ 20°C

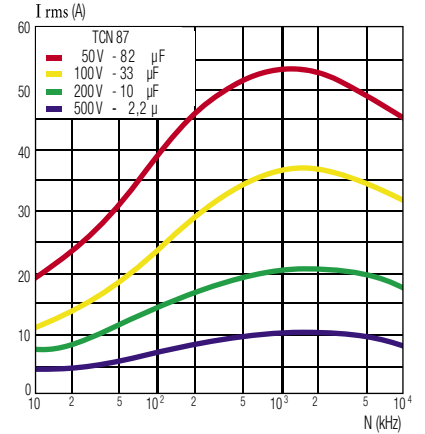



FEATURES

- Multilayer chip ceramic capacitors
- Dielectric type II
- Capacitance range: 47nf to 27 μ F
- Voltage range: 50 V_{DC} to 500 V_{DC}

PACKAGING

«BLISTER» BOXES:

For all products, special «blister» boxes are used to optimize the protection of the parts during the carriage and the storage. Depending upon the termination (with or without connection) and the size, the number of the parts in each box is defined. Please, consult us for more details.

DIMENSIONS in inches (mm)

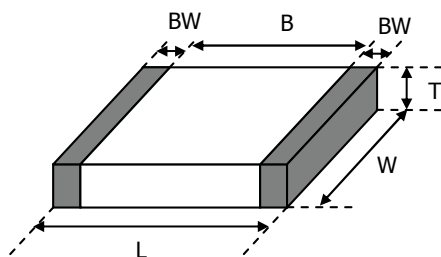

ELECTRICAL SPECIFICATIONS

Description	«X» Series (type II)	«T» Series (type II)
CECC	2R1	2R1
EIA	X7R	X7R
Exxelia Temex Code	X	T
Operating temperature range	-55°C to +125°C	-55°C to +125°C
Maximum Δ C/°C over Temperature range without voltage applied	$\pm 15\%$	$\pm 15\%$
Ageing	$\leq 2.5\%$ per decade hour	$\leq 2.5\%$ per decade hour
Dissipation Factor (DF)	$\leq 2.5\%$	$\leq 2.5\%$
Voltage proof	$U_R \leq 200$ V: $2.5 \times U_R$ $U_R > 200$ V: $2.0 \times U_R$	$U_R \leq 200$ V: $2.5 \times U_R$ $U_R > 200$ V: $2.0 \times U_R$
Insulation Resistance (IR) at 25°C under U_R	100G Ω or 1000 Ω .F whichever is the less	100G Ω or 1000 Ω .F whichever is the less
Insulation Resistance (IR) at 125°C under U_R	10G Ω or 100 Ω .F whichever is the less	10G Ω or 100 Ω .F whichever is the less
Measurement Conditions for C and DF at 20°C	≤ 100 pF: 1MHz / 1Vrms (no bias) > 100 pF: 1KHz / 1Vrms (no bias)	≤ 100 pF: 1MHz / 1Vrms (no bias) > 100 pF: 1KHz / 1Vrms (no bias)
Capacitance versus applied Voltage and Temperature	See page 68	See page 68

HIGH CAPACITANCE

HOW TO ORDER

501	R	6560	X	105	K	P	-	-RoHS
Rated voltage	Series	Exxelia size code	Dielectric code	Capacitance	Tolerance	Termination	Coating	RoHS compliant
500: 50 V 101: 100 V 201: 200 V 501: 500 V	R: High Capacitance Chips	2225 3033 3740 5440 5550 6560 6080 8060 45107	X = X7R T = X7R	1 st two digits represent significant figures; last digit specifies the number of zeros to follow. Examples: 104: 0.1 μ F 335: 3.3 μ F 276: 27 μ F	K = $\pm 10\%$ M = $\pm 20\%$	P (RoHS) Ag, non magnetic. Lead status: 0% Pb. T (not RoHS) P termination with Sn/Pb/Ag solder dipping, non magnetic Lead status: 36% Pb.	Not applicable	- = Not RoHS compliant For P termination, only the RoHS version exists. The RoHS suffix can be added for information.

R Series (Chips)

High Capacitance Chips Capacitors

STANDARD RATINGS

Dimensions Inches (mm)	Exxelia size code	2225				3033				3740				Capacitance value coded (C _F)				
	L	0.224 ± 0.016 (5.7 ± 0.4)				0.291 ± 0.02 (7.4 ± 0.5)				0.378 ± 0.02 (9.6 ± 0.5)								
	W	0.252 ± 0.016 (6.4 ± 0.4)				0.315 ± 0.02 (8 ± 0.5)				0.386 ± 0.02 (9.8 ± 0.5)								
BW min.	0.112 (0.3)				0.019 (0.5)				0.019 (0.5)									
BW max.	0.056 (1.4)				0.079 (2)				0.079 (2)									
U _R	50 V		100 V		200 V		500 V		50 V		100 V		200 V		500 V			
Dielectric	X	T	X	T	X	T	X	T	X	T	X	T	X	T	X	T		
47nf																	473	
56																	563	
68																	683	
82																	823	
100					0.071 (1.8)	0.119 (3)	0.091 (2.3)				0.099 (2.5)	0.103 (2.6)			0.119 (3)		104	
120					0.071 (1.8)	0.119 (3)	0.091 (2.3)				0.099 (2.5)	0.103 (2.6)			0.119 (3)		124	
150					0.079 (2)	0.130 (3.3)	0.091 (2.3)				0.099 (2.5)	0.103 (2.6)			0.119 (3)		154	
180	0.071 (1.8)	0.071 (1.8)	0.079 (2)	0.150 (3.8)	0.103 (2.6)					0.126 (3.2)	0.103 (2.6)		0.079 (2.1)	0.119 (3)	0.103 (2.6)	184		
220	0.071 (1.8)	0.071 (1.8)	0.099 (2.5)	0.177 (4.5)	0.111 (2.8)					0.126 (3.2)	0.103 (2.6)		0.079 (2.1)	0.119 (3)	0.103 (2.6)	224		
270	0.071 (1.8)	0.071 (1.8)	0.099 (2.5)	0.091 (2.3)	0.123 (3.1)			0.079 (2.1)		0.138 (3.5)	0.103 (2.6)		0.079 (2.1)	0.119 (3)	0.103 (2.6)	274		
330	0.071 (1.8)	0.071 (1.8)	0.119 (3)	0.091 (2.3)		0.079 (2.1)	0.079 (2.1)	0.079 (2.1)		0.165 (4.2)	0.111 (2.8)	0.079 (2.1)	0.079 (2.1)	0.079 (2.1)	0.130 (3.3)	0.103 (2.6)	334	
390	0.071 (1.8)	0.071 (1.8)	0.119 (3)	0.091 (2.3)		0.079 (2.1)	0.079 (2.1)	0.079 (2.1)		0.123 (3.1)	0.079 (2.1)	0.079 (2.1)	0.079 (2.1)	0.079 (2.1)	0.138 (3.5)	0.103 (2.6)	394	
470	0.071 (1.8)	0.071 (1.8)	0.130 (3.3)	0.091 (2.3)		0.079 (2.1)	0.079 (2.1)	0.079 (2.1)	0.091 (2.3)	0.138 (3.5)	0.079 (2.1)	0.079 (2.1)	0.079 (2.1)	0.079 (2.1)	0.158 (4)	0.103 (2.6)	474	
560	0.079 (2)	0.079 (2)	0.154 (3.9)	0.099 (2.5)		0.079 (2.1)	0.079 (2.1)	0.099 (2.5)	0.091 (2.3)		0.079 (2.1)	0.079 (2.1)	0.079 (2.1)	0.079 (2.1)	0.169 (4.3)	0.115 (2.9)	564	
680	0.079 (2)	0.091 (2.3)	0.079 (2)	0.091 (2.3)	0.122 (3.1)		0.079 (2.1)	0.079 (2.1)	0.119 (3)	0.091 (2.3)		0.079 (2.1)	0.079 (2.1)	0.099 (2.5)		0.134 (3.4)	684	
820	0.079 (2)	0.091 (2.3)	0.079 (2)	0.091 (2.3)	0.126 (3.2)		0.079 (2.1)	0.079 (2.1)	0.138 (3.5)	0.095 (2.4)		0.079 (2.1)	0.079 (2.1)	0.099 (2.5)	0.091 (2.3)	0.150 (3.8)	824	
1 µF	0.087 (2.2)	0.091 (2.3)	0.087 (2.2)	0.091 (2.3)		0.099 (2.5)	0.099 (2.5)			0.103 (2.6)		0.079 (2.1)	0.079 (2.1)	0.119 (3)	0.091 (2.3)		105	
1.2	0.099 (2.5)	0.091 (2.3)	0.099 (2.5)	0.091 (2.3)		0.099 (2.5)	0.099 (2.5)			0.115 (2.9)		0.079 (2.1)	0.079 (2.1)	0.138 (3.5)	0.091 (2.3)		125	
1.5	0.119 (3)	0.091 (2.3)	0.119 (3)	0.091 (2.3)		0.111 (2.8)	0.091 (2.3)	0.111 (2.8)	0.091 (2.3)	0.134 (3.4)		0.079 (2.1)	0.091 (2.3)	0.079 (2.1)	0.091 (2.3)	0.158 (4)	0.103 (2.6)	155
1.8	0.126 (3.2)	0.091 (2.3)	0.126 (3.2)	0.091 (2.3)		0.111 (2.8)	0.091 (2.3)	0.111 (2.8)	0.091 (2.3)			0.099 (2.5)	0.091 (2.3)	0.099 (2.5)	0.091 (2.3)	0.181 (4.6)	0.111 (2.8)	185
2.2	0.315 (3.8)	0.103 (2.6)	0.315 (3.8)	0.103 (2.6)		0.111 (2.8)	0.091 (2.3)	0.111 (2.8)	0.091 (2.3)			0.099 (2.5)	0.091 (2.3)	0.099 (2.5)	0.091 (2.3)	0.126 (3.2)		225
2.7		0.115 (2.9)		0.115 (2.9)		0.130 (3.3)	0.095 (2.4)	0.130 (3.3)	0.095 (2.4)			0.111 (2.8)	0.091 (2.3)	0.111 (2.8)	0.091 (2.3)	0.142 (3.6)		275
3.3		0.126 (3.2)		0.126 (3.2)		0.150 (3.8)	0.099 (2.5)	0.150 (3.8)	0.099 (2.5)			0.111 (2.8)	0.091 (2.3)	0.111 (2.8)	0.091 (2.3)		335	
3.9							0.111 (2.8)		0.111 (2.8)			0.130 (3.3)	0.091 (2.3)	0.130 (3.3)	0.091 (2.3)		395	
4.7							0.123 (3.1)		0.123 (3.1)			0.138 (3.5)	0.091 (2.3)	0.138 (3.5)	0.091 (2.3)		475	
5.6												0.142 (3.6)	0.103 (2.6)	0.142 (3.6)	0.103 (2.6)		565	
6.8												0.119 (3)		0.119 (3)			685	
8.2												0.142 (3.6)		0.142 (3.6)			825	
10												0.150 (3.8)		0.150 (3.8)			106	
12																	126	

The thickness Tmax in inches (in mm) is indicated in the cells.

High Capacitance Chips Capacitors

R Series (Chips)

STANDARD RATINGS

Dimensions inches (mm)	Exxelia size code	5550								6560								6080								Capacitance value coded (C _n)
	L	0.539 ± 0.02 (13.7 ± 0.5)								0.665 ± 0.032 (16.9 ± 0.8)								0.591 ± 0.032 (15 ± 0.8)								
	W	0.484 ± 0.02 (12.3 ± 0.5)								0.610 ± 0.032 (15.5 ± 0.8)								0.778 ± 0.0322 (19.8 ± 0.8)								
	BW min.	0.019 (0.5)								0.019 (0.5)								0.019 (0.5)								
BW max.	0.079 (2)								0.079 (2)								0.079 (2)									
U _R	50 V		100 V		200 V		500 V		50 V		100 V		200 V		500 V		50 V		100 V		200 V		500 V			
Dielectric	X	T	X	T	X	T	X	T	X	T	X	T	X	T	X	T	X	T	X	T	X	T	X	T		
270nf							0.099 (2.5)	0.103 (2.6)							0.099 (2.5)	0.103 (2.6)								274		
330							0.099 (2.5)	0.103 (2.6)							0.099 (2.5)	0.103 (2.6)								334		
390							0.099 (2.5)	0.103 (2.6)							0.099 (2.5)	0.103 (2.6)								394		
470							0.119 (3)	0.103 (2.6)							0.099 (2.5)	0.103 (2.6)								474		
560							0.119 (3)	0.103 (2.6)					0.099 (2.5)		0.099 (2.5)	0.103 (2.6)								564		
680							0.119 (3)	0.103 (2.6)					0.099 (2.5)		0.099 (2.5)	0.103 (2.6)						0.119 (3)	0.103 (2.6)	684		
820					0.119 (3)		0.138 (3.5)	0.103 (2.6)					0.099 (2.5)		0.119 (3)	0.103 (2.6)						0.119 (3)	0.103 (2.6)	824		
1 µF	0.099 (2.5)		0.099 (2.5)		0.119 (3)		0.166 (4.2)	0.111 (2.8)	0.099 (2.5)		0.099 (2.5)		0.099 (2.5)	0.103 (2.6)	0.119 (3)	0.103 (2.6)						0.119 (3)	0.103 (2.6)	105		
1.2	0.099 (2.5)		0.099 (2.5)		0.119 (3)	0.103 (2.6)	0.185 (4.7)	0.130 (3.3)	0.099 (2.5)		0.099 (2.5)		0.099 (2.5)	0.103 (2.6)	0.138 (3.5)	0.103 (2.6)						0.138 (3.5)	0.103 (2.6)	125		
1.5	0.099 (2.5)		0.099 (2.5)		0.119 (3)	0.103 (2.6)	0.142 (3.6)	0.099 (2.5)		0.099 (2.5)		0.099 (2.5)	0.103 (2.6)	0.158 (4)	0.119 (3)						0.119 (3)	0.158 (4)	0.103 (2.6)	155		
1.8	0.099 (2.5)		0.099 (2.5)		0.119 (3)	0.103 (2.6)	0.162 (4.1)	0.099 (2.5)		0.099 (2.5)		0.099 (2.5)	0.103 (2.6)	0.178 (4.5)	0.119 (3)						0.119 (3)	0.178 (4.5)	0.103 (2.6)	185		
2.2	0.099 (2.5)		0.099 (2.5)		0.119 (3)	0.103 (2.6)		0.099 (2.5)		0.099 (2.5)		0.099 (2.5)	0.103 (2.6)		0.130 (3.3)						0.119 (3)	0.103 (2.6)	0.178 (4.5)	0.103 (2.6)	225	
2.7	0.099 (2.5)		0.099 (2.5)		0.138 (3.5)	0.103 (2.6)		0.099 (2.5)	0.103 (2.6)	0.099 (2.5)	0.103 (2.6)	0.119 (3)	0.103 (2.6)		0.150 (3.8)						0.119 (3)	0.103 (2.6)	0.130 (3.3)	275		
3.3	0.099 (2.5)	0.103 (2.6)	0.099 (2.5)	0.103 (2.6)	0.158 (4)	0.111 (2.8)		0.099 (2.5)	0.103 (2.6)	0.099 (2.5)	0.103 (2.6)	0.119 (3)	0.103 (2.6)		0.170 (4.3)						0.119 (3)	0.103 (2.6)	0.154 (3.9)	335		
3.9	0.099 (2.5)	0.103 (2.6)	0.099 (2.5)	0.103 (2.6)		0.123 (3.1)		0.099 (2.5)	0.103 (2.6)	0.099 (2.5)	0.103 (2.6)	0.138 (3.5)	0.103 (2.6)		0.119 (3)		0.119 (3)				0.138 (3.5)	0.103 (2.6)	0.174 (4.4)	395		
4.7	0.119 (3)	0.103 (2.6)	0.119 (3)	0.103 (2.6)		0.138 (3.5)		0.099 (2.5)	0.103 (2.6)	0.099 (2.5)	0.103 (2.6)	0.158 (4)	0.103 (2.6)		0.119 (3)		0.119 (3)				0.158 (4)	0.103 (2.6)		475		
5.6	0.119 (3)	0.103 (2.6)	0.119 (3)	0.103 (2.6)		0.162 (4.1)		0.099 (2.5)	0.103 (2.6)	0.099 (2.5)	0.103 (2.6)		0.115 (2.9)		0.119 (3)		0.119 (3)				0.158 (4)	0.103 (2.6)		565		
6.8	0.119 (3)	0.103 (2.6)	0.119 (3)	0.103 (2.6)				0.099 (2.5)	0.103 (2.6)	0.099 (2.5)	0.103 (2.6)		0.130 (3.3)		0.119 (3)	0.103 (2.6)	0.119 (3)	0.103 (2.6)	0.178 (4.5)	0.119 (3)				685		
8.2	0.138 (3.5)	0.103 (2.6)	0.138 (3.5)	0.103 (2.6)				0.119 (3)	0.103 (2.6)	0.119 (3)	0.103 (2.6)		0.150 (3.8)		0.119 (3)	0.103 (2.6)	0.119 (3)	0.103 (2.6)			0.142 (3.6)			825		
10	0.150 (3.8)	0.103 (2.6)	0.150 (3.8)	0.103 (2.6)				0.119 (3)	0.103 (2.6)	0.119 (3)	0.103 (2.6)				0.138 (3.5)	0.103 (2.6)	0.138 (3.5)	0.103 (2.6)			0.150 (3.8)			106		
12	0.158 (4)	0.111 (2.8)	0.158 (4)	0.111 (2.8)				0.138 (3.5)	0.103 (2.6)	0.138 (3.5)	0.103 (2.6)				0.138 (3.5)	0.103 (2.6)	0.138 (3.5)	0.103 (2.6)						126		
15		0.126 (3.2)		0.126 (3.2)				0.158 (4)	0.103 (2.6)	0.158 (4)	0.103 (2.6)				0.138 (3.5)	0.103 (2.6)	0.138 (3.5)	0.103 (2.6)						156		
18								0.103 (2.6)		0.103 (2.6)							0.103 (2.6)				0.103 (2.6)			186		
22								0.119 (3)		0.119 (3)							0.111 (2.8)				0.111 (2.8)			226		
27								0.142 (3.6)		0.142 (3.6)							0.130 (3.3)				0.130 (3.3)			276		

The thickness Tmax in inches (in mm) is indicated in the cells.

R Series (Chips)

High Capacitance Chips Capacitors

STANDARD RATINGS

Exxelia size code	8060								45107								Capacitance value coded (C _R)	
	0.78 ± 0.032 (19.8 ± 0.8)								0.425 ± 0.02 (10.8 ± 0.5)									
Dimensions inches (mm)	0.587 ± 0.032 (14.9 ± 0.8)								1.083 max (27.5 max)									
	0.019 (0.5)								0.019 (0.5)									
U _R		50 V		100 V		200 V		500 V		50 V		100 V		200 V		500 V		
Dielectric		X	T	X	T	X	T	X	T	X	T	X	T	X	T	X	T	
270nf																		274
330																		334
390																		394
470																		474
560																		564
680								0.119 (3)	0.103 (2.6)					0.138 (3.5)	0.123 (3.1)			684
820								0.119 (3)	0.103 (2.6)				0.119 (3)	0.119 (3)	0.138 (3.5)	0.123 (3.1)		824
1 μF								0.119 (3)	0.103 (2.6)	0.119 (3)		0.119 (3)		0.119 (3)	0.119 (3)	0.150 (3.8)	0.123 (3.1)	105
1.2								0.138 (3.5)	0.103 (2.6)	0.119 (3)		0.119 (3)		0.119 (3)	0.119 (3)	0.150 (3.8)	0.123 (3.1)	125
1.5						0.119 (3)		0.158 (4)	0.103 (2.6)	0.119 (3)	0.119 (3)	0.119 (3)	0.119 (3)	0.119 (3)	0.119 (3)	0.158 (4)	0.123 (3.1)	155
1.8					0.119 (3)			0.178 (4.5)	0.103 (2.6)	0.119 (3)	0.119 (3)	0.119 (3)	0.119 (3)	0.119 (3)	0.119 (3)	0.178 (4.5)	0.123 (3.1)	185
2.2					0.119 (3)	0.103 (2.6)		0.178 (4.5)	0.103 (2.6)	0.119 (3)	0.119 (3)	0.119 (3)	0.119 (3)	0.138 (3.5)	0.119 (3)		0.123 (3.1)	225
2.7					0.119 (3)	0.103 (2.6)			0.130 (3.3)	0.119 (3)	0.119 (3)	0.119 (3)	0.119 (3)	0.150 (3.8)	0.119 (3)		0.123 (3.1)	275
3.3					0.119 (3)	0.103 (2.6)			0.154 (3.9)	0.119 (3)	0.119 (3)	0.119 (3)	0.119 (3)	0.158 (4)	0.119 (3)		0.158 (4)	335
3.9	0.119 (3)		0.119 (3)		0.138 (3.5)	0.103 (2.6)		0.174 (4.4)		0.119 (3)	0.119 (3)	0.119 (3)	0.119 (3)	0.158 (4)	0.119 (3)			395
4.7	0.119 (3)		0.119 (3)		0.158 (4)	0.103 (2.6)				0.119 (3)	0.119 (3)	0.119 (3)	0.119 (3)	0.158 (4)	0.119 (3)			475
5.6	0.119 (3)		0.119 (3)		0.158 (4)	0.103 (2.6)				0.119 (3)	0.119 (3)	0.119 (3)	0.119 (3)		0.119 (3)			565
6.8	0.119 (3)	0.103 (2.6)	0.119 (3)	0.103 (2.6)	0.178 (4.5)	0.119 (3)				0.119 (3)	0.119 (3)	0.119 (3)	0.119 (3)		0.158 (4)			685
8.2	0.119 (3)	0.103 (2.6)	0.119 (3)	0.103 (2.6)		0.142 (3.6)				0.119 (3)	0.119 (3)	0.119 (3)	0.119 (3)					825
10	0.138 (3.5)	0.103 (2.6)	0.138 (3.5)	0.103 (2.6)		0.150 (3.8)				0.138 (3.5)	0.119 (3)	0.138 (3.5)	0.119 (3)					106
12	0.138 (3.5)	0.103 (2.6)	0.138 (3.5)	0.103 (2.6)						0.138 (3.5)	0.119 (3)	0.138 (3.5)	0.119 (3)					126
15	0.138 (3.5)	0.103 (2.6)	0.138 (3.5)	0.103 (2.6)						0.138 (3.5)	0.119 (3)	0.138 (3.5)	0.119 (3)					156
18		0.103 (2.6)		0.103 (2.6)							0.119 (3)		0.119 (3)					186
22		0.111 (2.8)		0.111 (2.8)							0.119 (3)		0.119 (3)					226
27		0.130 (3.3)		0.130 (3.3)														276

The thickness Tmax in inches (in mm) is indicated in the cells.

Radial Leaded Conformal Coated Capacitors

R Series (Leaded)



FEATURES

- Multilayer conformal coated radial ceramic capacitors
- Dielectric type II
- Capacitance range: 47nf to 27 μ F
- Voltage range: 50 V_{DC} to 500 V_{DC}

PACKAGING

«BLISTER» BOXES:

For all products, special «blister» boxes are used to optimize the protection of the parts during the carriage and the storage. Depending upon the termination (with or without connection) and the size, the number of the parts in each box is defined. Please, consult us for more details.

DIMENSIONS in inches (mm)

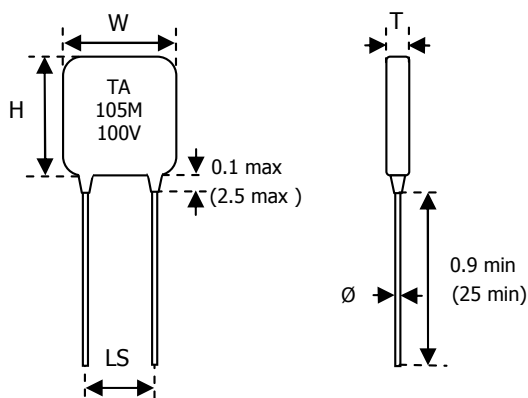

ELECTRICAL SPECIFICATIONS

Description	«X» Series	«T» Series
CECC	2R1	2R1
EIA	X7R	X7R
Exxelia Temex Code	X	T
Operating temperature range	-55°C to +125°C	-55°C to +125°C
Maximum Δ C/% over Temperature range without voltage applied	\pm 15%	\pm 15%
Ageing	\leq 2.5% per decade hour	\leq 2.5% per decade hour
Dissipation Factor (DF)	\leq 2.5%	\leq 2.5%
Voltage proof	$U_R \leq 200$ V: 2.5 x U_R $U_R > 200$ V: 2.0 x U_R	$U_R \leq 200$ V: 2.5 x U_R $U_R > 200$ V: 2.0 x U_R
Insulation Resistance (IR) at 25°C under U_R	100G Ω or 1000 Ω .F whichever is the less	100G Ω or 1000 Ω .F whichever is the less
Insulation Resistance (IR) at 125°C under U_R	10G Ω or 100 Ω .F whichever is the less	10G Ω or 100 Ω .F whichever is the less
Measurement Conditions for C and DF at 20°C	\leq 100pF: 1MHz / 1Vrms (no bias) $>$ 100pF: 1KHz / 1Vrms (no bias)	\leq 100pF: 1MHz / 1Vrms (no bias) $>$ 100pF: 1KHz / 1Vrms (no bias)
Capacitance versus applied Voltage and Temperature	See page 68	See page 68

MARKING

Size	Marking codes	Example
\leq 2225	Cap code + Tolerance code Rated voltage value	103M 100 V
$>$ 2225	«TA» logo Cap code + Tolerance code Rated voltage value	TA 103M 100 V

Note: the marking is only available for leaded capacitors.

HOW TO ORDER

501	R	6560	X	105	K	R	-	-RoHS	
Rated voltage	Series	Exxelia size code	Dielectric code	Capacitance	Tolerance	Termination	Coating	RoHS compliant	
500: 50 V 101: 100 V 201: 200 V 501: 500 V	R: Radial leaded 2 wires, epoxy coated.	2225 3033 3740 5440 5550 6560 6080 8060 45107	X = X7R T = X7R	1 st two digits represent significant figures; last digit specifies the number of zeros to follow. Examples: 104: 0.1 μ F 335: 3.3 μ F 276: 27 μ F	K = \pm 10% M = \pm 20%	R (RoHS) R (not RoHS)	100% tinned copper, non magnetic. Lead status: 0% Pb. Sn (70%) Pb (30%) plated Copper, non magnetic. Lead status: Pb 30% of the plated layer	Not applicable	- = Not RoHS compliant Both RoHS and non-RoHS versions exist. This is due to the wishes of some customers who still need non-RoHS components in their applications. This suffix must be required for RoHS compliance.

R Series (Leaded)

Radial Leaded Conformal Coated Capacitors

STANDARD RATINGS

Dimensions Inches (mm)	Exxelia size code	2225								3033								3740								Capacitance value coded (C _R)
	W max.	0.300 (7.6)								0.434 (11.0)								0.500 (12.7)								
	H max.	0.386 (9.8)								0.434 (11.0)								0.485 (12.3)								
U _R	Dielectric	50 V		100 V		200 V		500 V		50 V		100 V		200 V		500 V		50 V		100 V		200 V		500 V		
		X	T	X	T	X	T	X	T	X	T	X	T	X	T	X	T	X	T	X	T	X	T	X	T	
	47nf								0.170 (4.3)																	473
	56								0.170 (4.3)																	563
	68								0.170 (4.3)																	683
	82								0.170 (4.3)																	823
	100					0.123 (3.1)		0.170 (4.3)	0.142 (3.6)						0.15 (3.8)	0.154 (3.9)							0.17 (4.3)		104	
	120					0.123 (3.1)		0.170 (4.3)	0.142 (3.6)						0.15 (3.8)	0.154 (3.9)							0.17 (4.3)		124	
	150					0.130 (3.3)		0.181 (4.6)	0.142 (3.6)						0.15 (3.8)	0.154 (3.9)							0.17 (4.3)		154	
	180	0.123 (3.1)		0.123 (3.1)		0.130 (3.3)		0.201 (5.1)	0.154 (3.9)						0.178 (4.5)	0.154 (3.9)					0.134 (3.4)		0.17 (4.3)	0.154 (3.9)	184	
	220	0.123 (3.1)		0.123 (3.1)		0.150 (3.8)		0.229 (5.8)	0.162 (4.1)						0.178 (4.5)	0.154 (3.9)					0.134 (3.4)		0.17 (4.3)	0.154 (3.9)	224	
	270	0.123 (3.1)		0.123 (3.1)		0.150 (3.8)	0.142 (3.6)		0.173 (4.4)				0.134 (3.4)		0.189 (4.8)	0.154 (3.9)					0.134 (3.4)		0.17 (4.3)	0.154 (3.9)	274	
	330	0.123 (3.1)		0.123 (3.1)		0.170 (4.3)	0.142 (3.6)			0.134 (3.4)	0.134 (3.4)		0.134 (3.4)		0.217 (5.5)	0.162 (4.1)	0.134 (3.4)			0.134 (3.4)		0.134 (3.4)		0.182 (4.6)	0.154 (3.9)	334
	390	0.123 (3.1)		0.123 (3.1)		0.170 (4.3)	0.142 (3.6)			0.134 (3.4)	0.134 (3.4)		0.134 (3.4)		0.174 (4.4)	0.134 (3.4)			0.134 (3.4)		0.134 (3.4)		0.189 (4.8)	0.154 (3.9)	394	
	470	0.123 (3.1)		0.123 (3.1)		0.181 (4.6)	0.142 (3.6)			0.134 (3.4)	0.134 (3.4)		0.134 (3.4)	0.142 (3.6)	0.189 (4.8)	0.134 (3.4)			0.134 (3.4)		0.134 (3.4)		0.209 (5.3)	0.154 (3.9)	474	
	560	0.130 (3.3)		0.130 (3.3)		0.205 (5.2)	0.150 (3.8)			0.134 (3.4)	0.134 (3.4)		0.15 (3.8)	0.142 (3.6)		0.134 (3.4)			0.134 (3.4)		0.134 (3.4)		0.221 (5.6)	0.166 (4.2)	564	
	680	0.130 (3.3)	0.142 (3.6)	0.130 (3.3)	0.142 (3.6)		0.173 (4.4)			0.134 (3.4)	0.134 (3.4)		0.17 (4.3)	0.142 (3.6)		0.134 (3.4)			0.134 (3.4)		0.150 (3.8)			0.186 (4.7)	684	
	820	0.130 (3.3)	0.142 (3.6)	0.130 (3.3)	0.142 (3.6)		0.177 (4.5)			0.134 (3.4)	0.134 (3.4)		0.189 (4.8)	0.146 (3.7)		0.134 (3.4)			0.134 (3.4)		0.150 (3.8)	0.142 (3.6)		0.201 (5.1)	824	
	1 µF	0.138 (3.5)	0.142 (3.6)	0.138 (3.5)	0.142 (3.6)					0.150 (3.8)	0.150 (3.8)			0.154 (3.9)		0.134 (3.4)			0.134 (3.4)		0.170 (4.3)	0.142 (3.6)			105	
	1.2	0.150 (3.8)	0.142 (3.6)	0.150 (3.8)	0.142 (3.6)					0.150 (3.8)	0.150 (3.8)			0.166 (4.2)		0.134 (3.4)			0.134 (3.4)		0.189 (4.8)	0.142 (3.6)			125	
	1.5	0.170 (4.3)	0.142 (3.6)	0.170 (4.3)	0.142 (3.6)					0.162 (4.1)	0.142 (3.6)	0.162 (4.1)	0.142 (3.6)		0.186 (4.7)		0.134 (3.4)	0.142 (3.6)	0.134 (3.4)	0.142 (3.6)	0.209 (5.3)	0.154 (3.9)			155	
	1.8	0.177 (4.5)	0.142 (3.6)	0.177 (4.5)	0.142 (3.6)					0.162 (4.1)	0.142 (3.6)	0.162 (4.1)	0.142 (3.6)				0.15 (3.8)	0.142 (3.6)	0.15 (3.8)	0.142 (3.6)	0.232 (5.9)	0.162 (4.1)			185	
	2.2	0.201 (5.1)	0.154 (3.9)	0.201 (5.1)	0.154 (3.9)					0.162 (4.1)	0.142 (3.6)	0.162 (4.1)	0.142 (3.6)				0.15 (3.8)	0.142 (3.6)	0.15 (3.8)	0.142 (3.6)		0.178 (4.5)		225		
	2.7		0.165 (4.2)		0.165 (4.2)					0.182 (4.6)	0.146 (3.7)	0.182 (4.6)	0.146 (3.7)				0.162 (4.1)	0.142 (3.6)	0.162 (4.1)	0.142 (3.6)		0.193 (4.9)		275		
	3.3		0.177 (4.5)		0.177 (4.5)					0.201 (5.1)	0.150 (3.8)	0.201 (5.1)	0.150 (3.8)				0.162 (4.1)	0.142 (3.6)	0.162 (4.1)	0.142 (3.6)				335		
	3.9										0.162 (4.1)		0.162 (4.1)				0.182 (4.6)	0.142 (3.6)	0.182 (4.6)	0.142 (3.6)				395		
	4.7										0.174 (4.4)		0.174 (4.4)				0.189 (4.8)	0.142 (3.6)	0.189 (4.8)	0.142 (3.6)				475		
	5.6																0.193 (4.9)	0.154 (3.9)	0.193 (4.9)	0.154 (3.9)				565		
	6.8																	0.17 (4.3)		0.17 (4.3)				685		
	8.2																	0.193 (4.9)		0.193 (4.9)				825		
	10																	0.201 (5.1)		0.201 (5.1)				106		

The thickness Tmax in inches (in mm) is indicated in the cells.

Radial Leaded Conformal Coated Capacitors

R Series (Leaded)

STANDARD RATINGS

Dimensions Inches (mm)	Exxelia size code	5550								6560								6080/8060								Capacitance value coded (C _R)
	W max.	0.678 (17.2)								0.800 (20.3)								0.741 / 0.930 (18.8) / (23.6)								
	H max.	0.583 (14.8)								0.721 (18.3)								0.890 / 0.697 (22.6) / (17.7)								
	LS	0.598 ± 0.02 (15.2 ± 0.5)								0.701 ± 0.02 (17.8 ± 0.5)								0.598 ± 0.02 (15.2 ± 0.5) / (20.3 ± 0.5)								
D ± 10%	0.035 (0.9)								0.035 (0.9)								0.035 / 0.035 (0.9) / (0.9)									
U _R	50 V		100 V		200 V		500 V		50 V		100 V		200 V		500 V		50 V		100 V		200 V		500 V			
Dielectric	X	T	X	T	X	T	X	T	X	T	X	T	X	T	X	T	X	T	X	T	X	T	X	T		
270nf								0.150 (3.8)	0.154 (3.9)							0.150 (3.8)	0.154 (3.9)							274		
330								0.150 (3.8)	0.154 (3.9)							0.150 (3.8)	0.154 (3.9)							334		
390								0.150 (3.8)	0.154 (3.9)							0.150 (3.8)	0.154 (3.9)							394		
470								0.170 (4.3)	0.154 (3.9)							0.150 (3.8)	0.154 (3.9)							474		
560								0.170 (4.3)	0.154 (3.9)					0.150 (3.8)		0.150 (3.8)	0.154 (3.9)							564		
680								0.170 (4.3)	0.154 (3.9)					0.150 (3.8)		0.150 (3.8)	0.154 (3.9)					0.170 (4.3)	0.154 (3.9)	684		
820							0.170 (4.3)	0.189 (4.8)	0.154 (3.9)					0.150 (3.8)		0.170 (4.3)	0.154 (3.9)					0.170 (4.3)	0.154 (3.9)	824		
1 µF	0.150 (3.8)		0.150 (3.8)		0.170 (4.3)		0.237 (6)	0.162 (4.1)	0.150 (3.8)		0.150 (3.8)		0.150 (3.8)	0.154 (3.9)	0.170 (4.3)	0.154 (3.9)						0.170 (4.3)	0.154 (3.9)	105		
1.2	0.150 (3.8)		0.150 (3.8)		0.170 (4.3)	0.154 (3.9)	0.182 (4.6)	0.150 (3.8)		0.150 (3.8)		0.150 (3.8)	0.154 (3.9)	0.189 (4.8)	0.154 (3.9)							0.189 (4.8)	0.154 (3.9)	125		
1.5	0.150 (3.8)		0.150 (3.8)		0.170 (4.3)	0.154 (3.9)	0.193 (4.9)	0.150 (3.8)		0.150 (3.8)		0.150 (3.8)	0.154 (3.9)	0.209 (5.3)	0.17 (4.3)				0.170 (4.3)			0.209 (5.3)	0.154 (3.9)	155		
1.8	0.150 (3.8)		0.150 (3.8)		0.170 (4.3)	0.154 (3.9)	0.213 (5.4)	0.150 (3.8)		0.150 (3.8)		0.150 (3.8)	0.154 (3.9)	0.229 (5.8)	0.17 (4.3)				0.170 (4.3)			0.229 (5.8)	0.154 (3.9)	185		
2.2	0.150 (3.8)		0.150 (3.8)		0.170 (4.3)	0.154 (3.9)		0.150 (3.8)		0.150 (3.8)		0.150 (3.8)	0.154 (3.9)		0.182 (4.6)				0.170 (4.3)	0.154 (3.9)	0.229 (5.8)	0.154 (3.9)		225		
2.7	0.150 (3.8)		0.150 (3.8)		0.189 (4.8)	0.154 (3.9)		0.150 (3.8)	0.154 (3.9)	0.150 (3.8)	0.154 (3.9)	0.170 (4.3)	0.154 (3.9)		0.201 (5.1)				0.170 (4.3)	0.154 (3.9)		0.182 (4.6)		275		
3.3	0.150 (3.8)	0.154 (3.9)	0.150 (3.8)	0.154 (3.9)	0.209 (5.3)	0.162 (4.1)		0.150 (3.8)	0.154 (3.9)	0.150 (3.8)	0.154 (3.9)	0.170 (4.3)	0.154 (3.9)		0.221 (5.6)				0.170 (4.3)	0.154 (3.9)		0.205 (5.2)		335		
3.9	0.150 (3.8)	0.154 (3.9)	0.150 (3.8)	0.154 (3.9)		0.174 (4.4)		0.150 (3.8)	0.154 (3.9)	0.150 (3.8)	0.154 (3.9)	0.189 (4.8)	0.154 (3.9)			0.170 (4.3)		0.170 (4.3)	0.189 (4.8)	0.154 (3.9)		0.225 (5.7)		395		
4.7	0.170 (4.3)	0.154 (3.9)	0.170 (4.3)	0.154 (3.9)		0.189 (4.8)		0.150 (3.8)	0.154 (3.9)	0.150 (3.8)	0.154 (3.9)	0.209 (5.3)	0.154 (3.9)			0.170 (4.3)		0.170 (4.3)	0.209 (5.3)	0.154 (3.9)				475		
5.6	0.170 (4.3)	0.154 (3.9)	0.170 (4.3)	0.154 (3.9)		0.213 (5.4)		0.150 (3.8)	0.154 (3.9)	0.150 (3.8)	0.154 (3.9)		0.166 (4.2)			0.170 (4.3)		0.170 (4.3)	0.209 (5.3)	0.154 (3.9)				565		
6.8	0.170 (4.3)	0.154 (3.9)	0.170 (4.3)	0.154 (3.9)				0.150 (3.8)	0.154 (3.9)	0.150 (3.8)	0.154 (3.9)		0.182 (4.6)			0.170 (4.3)	0.154 (3.9)	0.170 (4.3)	0.154 (3.9)	0.228 (5.8)	0.170 (4.3)			685		
8.2	0.189 (4.8)	0.154 (3.9)	0.189 (4.8)	0.154 (3.9)				0.170 (4.3)	0.154 (3.9)	0.170 (4.3)	0.154 (3.9)		0.201 (5.1)			0.170 (4.3)	0.154 (3.9)	0.170 (4.3)	0.154 (3.9)		0.193 (4.9)			825		
10	0.201 (5.1)	0.154 (3.9)	0.201 (5.1)	0.154 (3.9)				0.170 (4.3)	0.154 (3.9)	0.170 (4.3)	0.154 (3.9)					0.189 (4.8)	0.154 (3.9)	0.189 (4.8)	0.154 (3.9)		0.201 (5.1)			106		
12	0.209 (5.3)	0.162 (4.1)	0.209 (5.3)	0.162 (4.1)				0.189 (4.8)	0.154 (3.9)	0.189 (4.8)	0.154 (3.9)					0.189 (4.8)	0.154 (3.9)	0.189 (4.8)	0.154 (3.9)					126		
15		0.178 (4.5)		0.178 (4.5)				0.209 (5.3)	0.154 (3.9)	0.209 (5.3)	0.154 (3.9)					0.189 (4.8)	0.154 (3.9)	0.189 (4.8)	0.154 (3.9)					156		
18									0.154 (3.9)								0.154 (3.9)			0.154 (3.9)					186	
22									0.17 (4.3)										0.162 (4.1)			0.162 (4.1)			226	
27									0.193 (4.9)										0.182 (4.6)			0.182 (4.6)			276	

HIGH CAPACITANCE

The thickness Tmax in inches (in mm) is indicated in the cells.

TEF Serie

Radial Leaded Conformal Coated Capacitors



DIMENSIONS in inches (mm)

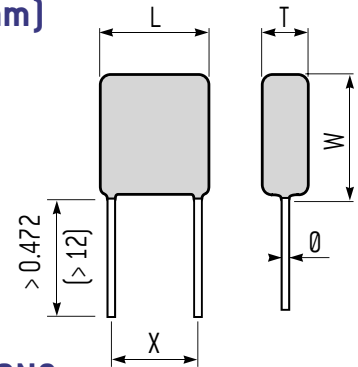

FEATURES

- Multilayer chips ceramic capacitors
- NPO dielectric
- Capacitance range: 10nF to 680nF
- Voltage range : 50 V_{DC} to 500 V_{DC}

PHYSICAL CHARACTERISTICS

CONSTRUCTION

Radial leaded conformal coating for through hole circuits.

MARKING

Series, Capacitance value, tolerance, rated voltage, date code.

ELECTRICAL SPECIFICATIONS

DIELECTRIC	NPO
Maximum $\Delta C/^{\circ}C$ over temp. range without voltage	NA
Temperature coefficient	(0 \pm 30)ppm/ $^{\circ}C$
Ageing	None
Operating temperature	-55 $^{\circ}C$ to +125 $^{\circ}C$
Rated voltage (U _{RC})	63 V _{DC} to 500 V _{DC}
Dielectric withstanding voltage	2.5 U _{RC} for U _{RC} < 500 V _{DC} 2 U _{RC} for U _{RC} = 500 V _{DC}
Capacitance	at 1kHz
Dissipation factor	\leq 0.15% at 1kHz
Insulation resistance at 25 $^{\circ}C$ under U _{RC}	\geq 1,000 M Ω . μ F

STANDARD RATINGS

Size	3033	3740	5550	6080	8060	
Size code	53	54	55	56	65	
Dimensions inches (mm)	L max.	0.400 (10.16)	0.500 (12.7)	0.689 (17.5)	0.760 (19.3)	0.985 (25)
	W max.	0.461 (11.7)	0.560 (14.2)	0.650 (16.5)	0.945 (24)	0.749 (19)
	T min.	0.197 (5)	0.197 (5)	0.197 (5)	0.197 (5)	0.197 (5)
	X	0.2 \pm 0.02 (5.08 \pm 0.5)	0.4 \pm 0.02 (10.16 \pm 0.5)	0.551 \pm 0.02 (14.7 \pm 0.5)	0.6 \pm 0.02 (15.24 \pm 0.5)	0.835 \pm 0.02 (21.2 \pm 0.5)
	$\phi \pm 10\%$	0.024 (0.6)	0.024 (0.6)	0.031 (0.8)	0.031 (0.8)	0.031 (0.8)
Rated voltage (U _{RC})	Min. Capacitance value	10nF	18nF	33nF	68nF	68nF
	63 V	100nF	180nF	330nF	680nF	680nF
	100 V	82nF	120nF	220nF	470nF	470nF
	200 V	56nF	82nF	180nF	330nF	330nF
	500 V	18nF	27nF	56nF	100nF	100nF

Available capacitance values: NPO dielectric: E6, E12, E24 (see page 14). Specific values upon request. The above table defines the standard products, other components may be built upon request.

HOW TO ORDER

T	EF	56	W	F	68nF	$\pm 10\%$	200 V	-
Series	Dielectric code	Exxelia size code	RoHS compliant	Quality level	Capacitance	Tolerance	Rated voltage	Reliability level
T = Radial leads, conformal coating	EF = NPO	53 54 55 56 65	- = No RoHS W = RoHS compliant	- = standard quality level F = Hi-Rel quality: screening in accordance with Exxelia specification	Capacitance value in clear	NPO: $\pm 1\%$ $\pm 2\%$ $\pm 5\%$ $\pm 10\%$ $\pm 20\%$	63 V 100 V 200 V 500 V	For F parts only. Acc. to Exxelia spec. - T5 T6 See page 15

High Capacitance Stacked Capacitors

SC / SV Series

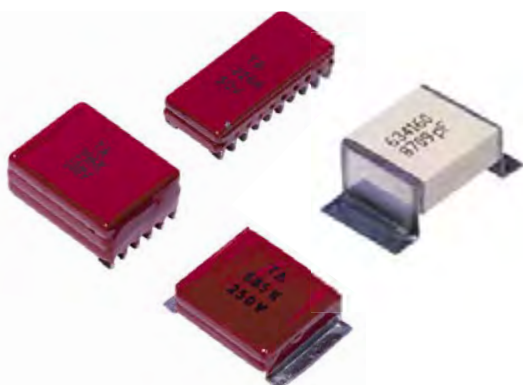

FEATURES

- Multilayer stacked ceramic capacitors
- Dielectric type II
- Capacitance range: 47nf to 390 μF
- Voltage range: 50 V_{DC} to 500 V_{DC}
- SV Series: 2 wires components
- SC Series: 4 wires (W4), Dual In Line (DIL) or ribbons terminations

MARKING

Size	Marking codes	Example
All sizes	«TA» logo	TA
	Cap code + Tolerance code	105M
	Rated voltage value	100 V

PACKAGING

«Blister» boxes:

For all products, special «blister» boxes are used to optimize the protection of the parts during the carriage and the storage. Depending upon the termination (with or without connection) and the size, the number of the parts in each box is defined. Please, consult us for more details.

ELECTRICAL SPECIFICATIONS

Description	«X» Series (type II)	«T» Series (type II)
CECC	2R1	2R1
EIA	X7R	X7R
Exxelia Temex Code	X	T
Operating temperature range	-55°C to +125°C	-55°C to +125°C
Maximum ΔC/°C over Temperature range without voltage applied	± 15%	± 15%
Ageing	≤2.5% per decade hour	≤2.5% per decade hour
Dissipation Factor (DF)	≤ 2.5%	≤ 2.5%
Voltage proof	U _R ≤ 200 V: 2.5 x U _R	U _R ≤ 200 V: 2.5 x U _R
	U _R > 200 V: 2.0 x U _R	U _R > 200 V: 2.0 x U _R
Insulation Resistance (IR) at 25°C under U _R	100GΩ or 1000Ω.F whichever is the less	100GΩ or 1000Ω.F whichever is the less
	10GΩ or 100Ω.F whichever is the less	10GΩ or 100Ω.F whichever is the less
Insulation Resistance (IR) at 125°C under U _R	100GΩ or 1000Ω.F whichever is the less	100GΩ or 1000Ω.F whichever is the less
	10GΩ or 100Ω.F whichever is the less	10GΩ or 100Ω.F whichever is the less
Measurement Conditions for C and DF at 20°C	≤ 100pF: 1MHz / 1Vrms (no bias)	≤ 100pF: 1MHz / 1Vrms (no bias)
	> 100pF: 1KHz / 1Vrms (no bias)	> 100pF: 1KHz / 1Vrms (no bias)
Capacitance versus applied Voltage and Temperature	See page 68	See page 68

HIGH CAPACITANCE

HOW TO ORDER

201	SV	01	X	105	K	R	-	-RoHS																		
Rated voltage	Series	Exxelia size code	Dielectric code	Capacitance	Tolerance	Termination	Coating	RoHS Compliant																		
500: 50 V 101: 100 V 201: 200 V 501: 500 V	SC SV	00 (SC only) 01 02 03 04 05 06 07 10 (SC only) 11 (SC only) 12 (SC only) 18 (SC only)	X = X7R T = X7R	1 st two digits represent significant figures; last digit specifies the number of zeros to follow. Examples: 104: 0.1μF 335: 3.3μF 156: 15μF 107: 10μF	K = ±10% M = ±20%	<table border="1"> <thead> <tr> <th colspan="2">SC Series</th> </tr> </thead> <tbody> <tr> <td>DN DIL N type</td> <td>RoHS = 100% tinned phosphor bronze, non magnetic. Lead status: 0% Pb.</td> </tr> <tr> <td>DJ DIL J type</td> <td>Non RoHS = Sn (60%) Pb (40%) plated phosphor bronze, non magnetic. Lead status: Pb 40% of the plated layer.</td> </tr> <tr> <td>DL DIL L type</td> <td></td> </tr> <tr> <td>RL Ribbon L type</td> <td>RoHS = 100% tinned copper, non magnetic. Lead status: 0% Pb</td> </tr> <tr> <td>RJ Ribbon J type</td> <td>RoHS = 100% tinned copper, non magnetic. Lead status: 0% Pb.</td> </tr> <tr> <td>W4 Radial 4 wires</td> <td>Non RoHS = Sn (70%) Pb (30%) plated Copper, non magnetic. Lead status: Pb 30% of the plated layer.</td> </tr> <tr> <th colspan="2">SV Series</th> </tr> <tr> <td>W2 Radial 2 wires</td> <td>See W4</td> </tr> </tbody> </table>	SC Series		DN DIL N type	RoHS = 100% tinned phosphor bronze, non magnetic. Lead status: 0% Pb.	DJ DIL J type	Non RoHS = Sn (60%) Pb (40%) plated phosphor bronze, non magnetic. Lead status: Pb 40% of the plated layer.	DL DIL L type		RL Ribbon L type	RoHS = 100% tinned copper, non magnetic. Lead status: 0% Pb	RJ Ribbon J type	RoHS = 100% tinned copper, non magnetic. Lead status: 0% Pb.	W4 Radial 4 wires	Non RoHS = Sn (70%) Pb (30%) plated Copper, non magnetic. Lead status: Pb 30% of the plated layer.	SV Series		W2 Radial 2 wires	See W4	- = uncoated and no marking U = uncoated and marked C = coated and marked	- = non-RoHS compliant Both RoHS and non-RoHS versions exist. This is due to the wishes of some customers who still need non-RoHS components in their applications. This suffix must be required for RoHS compliancy.
SC Series																										
DN DIL N type	RoHS = 100% tinned phosphor bronze, non magnetic. Lead status: 0% Pb.																									
DJ DIL J type	Non RoHS = Sn (60%) Pb (40%) plated phosphor bronze, non magnetic. Lead status: Pb 40% of the plated layer.																									
DL DIL L type																										
RL Ribbon L type	RoHS = 100% tinned copper, non magnetic. Lead status: 0% Pb																									
RJ Ribbon J type	RoHS = 100% tinned copper, non magnetic. Lead status: 0% Pb.																									
W4 Radial 4 wires	Non RoHS = Sn (70%) Pb (30%) plated Copper, non magnetic. Lead status: Pb 30% of the plated layer.																									
SV Series																										
W2 Radial 2 wires	See W4																									

SC / SV Series

High Capacitance Stacked Capacitors

DIMENSIONS in inches (mm)

SC SERIES

4 wires W4 terminations

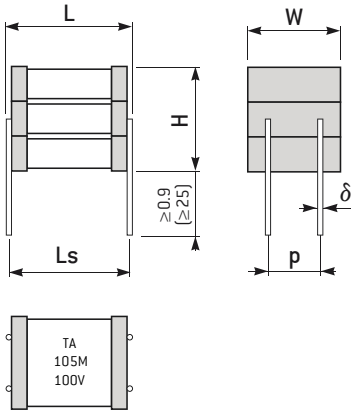

SC SERIES

Dual In Line DIL termination

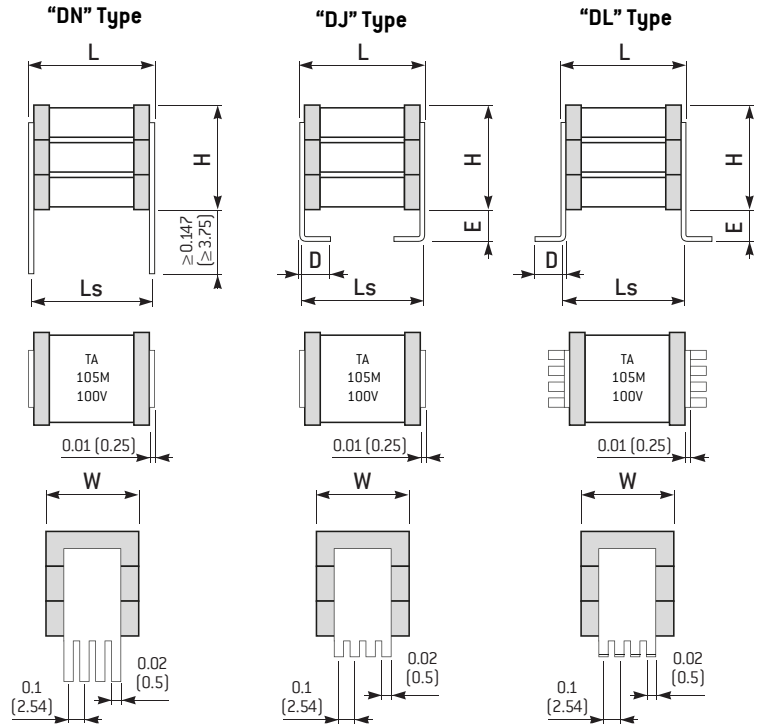

Note: the marking shown here is just given as an example

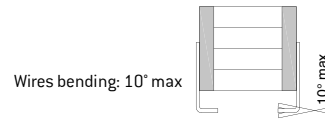

Size	L max.	W max.	Ls ± 0.02 (±0.5)	p ± 0.02 (±0.5)	δ ± 10%	H max.
SC02	0.469 (11.9)	0.449 (11.4)	0.400 (10.16)	0.300 (7.62)	0.024 (0.6)	
SC04	0.650 (16.5)	0.552 (14)	0.600 (15.24)	0.400 (10.16)	0.035 (0.9)	
SC05	0.788 (20)	0.654 (16.6)	0.701 (17.8)	0.400 (10.16)	0.035 (0.9)	
SC06	0.701 (17.8)	0.851 (21.6)	0.600 (15.24)	0.400 (10.16)	0.035 (0.9)	
SC07	0.894 (22.7)	0.654 (16.6)	0.800 (20.32)	0.400 (10.16)	0.035 (0.9)	

Please, consult the tables of standard ratings

Size	L max.	W max.	Ls ± 0.02* (±0.5)*	E ± 0.012 (±0.5)	D ± 0.02 (±0.5)	Number of leads per side	H max.
SC00	0.300 (7.62)	0.276 (7)	0.250 (6.35)	0.071 (1.8)	0.079 (2)	3	
SC01	0.402 (10.2)	0.378 (9.6)	0.300 (7.62)	0.059 (1.5)	0.098 (2.5)	3	
SC02	0.469 (11.9)	0.449 (11.4)	0.400 (10.16)	0.059 (1.5)	0.098 (2.5)	4	
SC04	0.650 (16.5)	0.552 (14)	0.539 (13.7)	0.059 (1.5)	0.098 (2.5)	5	
SC05	0.729 (18.5)	0.670 (17)	0.700 (17.78)	0.059 (1.5)	0.098 (2.5)	6	
SC06	0.701 (17.8)	0.851 (21.6)	0.600 (15.24)	0.059 (1.5)	0.098 (2.5)	7	
SC07	0.894 (22.7)	0.654 (16.6)	0.800 (20.32)	0.059 (1.5)	0.098 (2.5)	6	
SC10	0.520 (13.2)	1.083 (27.5)	0.453 (11.5)	0.083 (2.1)	0.102 (2.6)	10	
SC12	0.945 (24)	1.598 (40.6)	0.800 (20.32)	0.098 (2.5)	0.098 (2.5)	14	

Please, consult the tables of standard ratings

* Except for the SC07, tolerance = ± 0.032 in (±0.8mm).

High Capacitance Stacked Capacitors

SC / SV Series

DIMENSIONS in inches (mm)

SC SERIES

Ribbons R terminations

RJ Type (upon request)

RL Type (standard)

SV SERIES

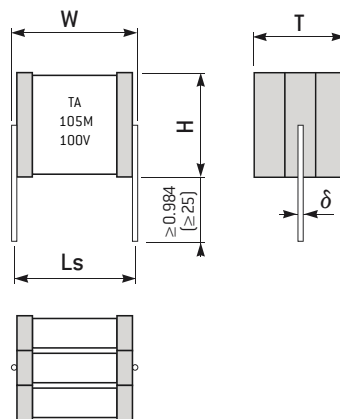
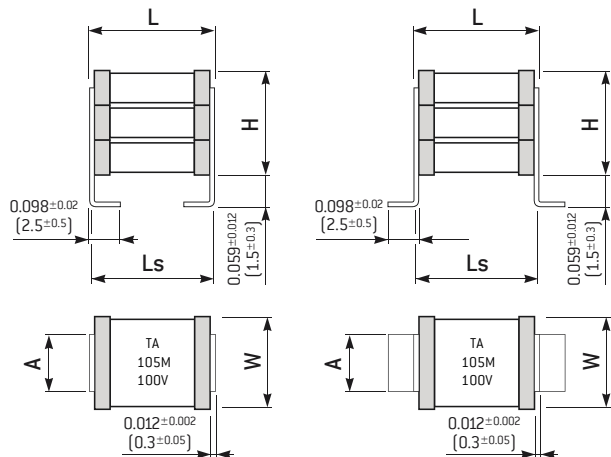

Note: the marking shown here is just given as an example. For the «RJ» version, please consult us.

HIGH CAPACITANCE

Size	L max.	W max.	A ± 0.008 [±0.2]	Ls ± 0.02 [±0.5]	H max.
SC01	0.402 [10.2]	0.378 [9.6]	0.315 [8]	0.415 [10.55]	Please, consult the tables of standard ratings
SC02	0.469 [11.9]	0.449 [11.4]	0.315 [8]	0.482 [12.25]	
SC04	0.650 [16.5]	0.552 [14]	0.315 [8]	0.663 [16.85]	
SC05	0.729 [18.5]	0.670 [17]	0.591 [15]	0.742 [18.85]	
SC06	0.701 [17.8]	0.851 [21.6]	0.591 [15]	0.715 [18.15]	
SC07	0.894 [22.7]	0.654 [16.6]	0.591 [15]	0.907 [23.05]	

Size	W max.	H max.	LS ± 0.02 [±0.5]	δ ± 10%	T max.
SV01	0.402 [10.2]	0.378 [9.6]	0.400 [10.16]	0.024 [0.6]	Please, consult the tables of standard ratings
SV02	0.469 [11.9]	0.449 [11.4]	0.400 [10.16]	0.024 [0.6]	
SV04	0.650 [16.5]	0.552 [14]	0.600 [15.24]	0.035 [0.9]	
SV05	0.788 [20]	0.654 [16.6]	0.701 [17.8]	0.035 [0.9]	
SV06	0.701 [17.8]	0.851 [21.6]	0.600 [15.24]	0.035 [0.9]	
SV07	0.894 [22.7]	0.654 [16.6]	0.800 [20.32]	0.035 [0.9]	

STANDARD RATINGS

Exxelia size code	2225								3033								Cap. code
	SC00								SC01 / SV01								
	50 V		100 V		200 V		500 V		50 V		100 V		200 V		500 V		
Dielectric code	X	T	X	T	X	T	X	T	X	T	X	T	X	T	X	T	
	47nf								0.118 (3)							0.083 (2.1)	
56								0.118 (3)							0.083 (2.1)		563
68								0.118 (3)							0.083 (2.1)		683
82								0.118 (3)							0.083 (2.1)		823
100					0.039 (1.8)		0.118 (3)	0.079 (2.3)					0.083 (2.1)	0.098 (2.5)	0.102 (2.6)		104
120					0.039 (1.8)		0.118 (3)	0.079 (2.3)					0.083 (2.1)	0.098 (2.5)	0.102 (2.6)		124
150					0.079 (2)		0.252 (6.4)	0.079 (2.3)					0.083 (2.1)	0.098 (2.5)	0.102 (2.6)		154
180	0.039 (1.8)		0.039 (1.8)		0.079 (2)		0.252 (6.4)	0.102 (2.6)	0.083 (2.1)	0.083 (2.1)	0.083 (2.1)		0.083 (2.1)	0.126 (3.2)	0.102 (2.6)		184
220	0.039 (1.8)		0.039 (1.8)		0.098 (2.5)		0.252 (6.4)	0.110 (2.8)	0.083 (2.1)	0.083 (2.1)	0.083 (2.1)		0.083 (2.1)	0.126 (3.2)	0.102 (2.6)		224
270	0.039 (1.8)		0.039 (1.8)		0.098 (2.5)	0.079 (2.3)	0.378 (9.6)	0.122 (3.1)	0.083 (2.1)	0.083 (2.1)	0.083 (2.1)		0.083 (2.1)	0.138 (3.5)	0.102 (2.6)		274
330	0.039 (1.8)		0.039 (1.8)		0.118 (3)	0.079 (2.3)	0.378 (9.6)	0.252 (6.4)	0.083 (2.1)	0.083 (2.1)	0.083 (2.1)		0.083 (2.1)	0.241 (6.1)	0.110 (2.8)		334
390	0.039 (1.8)		0.039 (1.8)		0.118 (3)	0.079 (2.3)	0.504 (12.8)	0.252 (6.4)	0.083 (2.1)	0.083 (2.1)	0.083 (2.1)		0.083 (2.1)	0.241 (6.1)	0.122 (3.1)		394
470	0.039 (1.8)		0.039 (1.8)		0.213 (5.4)	0.079 (2.3)	0.504 (12.8)	0.252 (6.4)	0.083 (2.1)	0.083 (2.1)	0.083 (2.1)	0.079 (2.3)	0.272 (6.9)	0.138 (3.5)			474
560	0.079 (2)		0.079 (2)		0.232 (5.9)	0.098 (2.5)	0.551 (14)	0.252 (6.4)	0.083 (2.1)	0.083 (2.1)	0.098 (2.5)	0.079 (2.3)	0.414 (10.5)	0.237 (6)			564
680	0.079 (2)	0.079 (2.3)	0.079 (2)	0.079 (2.3)	0.252 (6.4)	0.110 (2.8)	0.630 (16)	0.382 (9.7)	0.083 (2.1)	0.083 (2.1)	0.118 (3)	0.079 (2.3)	0.414 (10.5)	0.249 (6.3)			684
820	0.079 (2)	0.079 (2.3)	0.079 (2)	0.079 (2.3)	0.319 (8.1)	0.197 (5)	0.709 (18)	0.382 (9.7)	0.083 (2.1)	0.083 (2.1)	0.138 (3.5)	0.094 (2.4)	0.548 (13.9)	0.260 (6.6)			824
1 µF	0.087 (2.2)	0.079 (2.3)	0.087 (2.2)	0.079 (2.3)	0.378 (9.6)	0.213 (5.4)		0.512 (13)	0.098 (2.5)	0.098 (2.5)	0.174 (4.4)	0.102 (2.6)	0.583 (14.8)	0.292 (7.4)			105
1.2	0.098 (2.5)	0.079 (2.3)	0.098 (2.5)	0.079 (2.3)	0.504 (12.8)	0.236 (6)			0.098 (2.5)	0.098 (2.5)	0.213 (5.4)	0.114 (2.9)	0.669 (17.6)	0.390 (9.9)			125
1.5	0.118 (3)	0.079 (2.3)	0.118 (3)	0.079 (2.3)	0.551 (14)	0.315 (8.1)			0.110 (2.8)	0.079 (2.3)	0.110 (2.8)	0.079 (2.3)	0.260 (6.6)	0.134 (3.4)		0.438 (11.1)	155
1.8	0.173 (4.4)	0.079 (2.3)	0.173 (4.4)	0.079 (2.3)	0.630 (16.4)	0.354 (9)			0.110 (2.8)	0.079 (2.3)	0.110 (2.8)	0.079 (2.3)	0.347 (8.8)	0.256 (6.5)		0.583 (14.8)	185
2.2	0.197 (5.1)	0.102 (2.6)	0.197 (5.1)	0.102 (2.6)	0.630 (16.4)	0.394 (10.8)			0.110 (2.8)	0.079 (2.3)	0.110 (2.8)	0.079 (2.3)	0.426 (10.8)	0.256 (6.5)		0.630 (16)	225
2.7	0.232 (5.9)	0.114 (2.9)	0.232 (5.9)	0.114 (2.9)		0.472 (12)			0.130 (3.3)	0.094 (2.4)	0.130 (3.3)	0.094 (2.4)	0.552 (14)	0.256 (6.5)			275
3.3	0.296 (7.5)	0.197 (5)	0.296 (7.5)	0.197 (5)		0.535 (13.6)			0.150 (3.8)	0.098 (2.5)	0.150 (3.8)	0.098 (2.5)	0.591 (15)	0.367 (9.3)			335
3.9	0.339 (8.6)	0.209 (5.3)	0.339 (8.6)	0.209 (5.3)					0.237 (6)	0.110 (2.8)	0.237 (6)	0.110 (2.8)		0.394 (10)			395
4.7	0.378 (9.6)	0.232 (5.9)	0.378 (9.6)	0.232 (5.9)					0.237 (6)	0.122 (3.1)	0.237 (6)	0.122 (3.1)		0.489 (12.4)			475
5.6	0.484 (12.3)	0.244 (6.2)	0.484 (12.3)	0.244 (6.2)					0.276 (7)	0.205 (5.2)	0.276 (7)	0.205 (5.2)		0.536 (13.6)			565
6.8	0.504 (12.8)	0.335 (8.5)	0.504 (12.8)	0.335 (8.5)					0.315 (8)	0.213 (5.4)	0.315 (8)	0.213 (5.4)					685
8.2	0.630 (16)	0.343 (8.7)	0.630 (16)	0.343 (8.7)					0.434 (11)	0.237 (6)	0.434 (11)	0.237 (6)					825
10		0.472 (12.2)		0.472 (12.2)					0.473 (12)	0.319 (8.1)	0.473 (12)	0.319 (8.1)					106
12		0.472 (12.2)		0.472 (12.2)					0.552 (14)	0.355 (9)	0.552 (14)	0.355 (9)					126
15										0.473 (12)		0.473 (12)					156
18										0.520 (13.2)		0.520 (13.2)					186

The thickness H max in inches (in mm) for the SC Series or the height T max in inches (in mm) for the SV Series is indicated in the cells.

High Capacitance Stacked Capacitors

SC / SV Series

STANDARD RATINGS

Exxelia size code	3740								5550								Cap. code	
	SC02 / SV02								SC04 / SV04									
	50 V		100 V		200 V		500 V		50 V		100 V		200 V		500 V			
Dielectric code	X	T	X	T	X	T	X	T	X	T	X	T	X	T	X	T		
100nf								0.118 (3)									104	
120								0.118 (3)									124	
150								0.118 (3)									154	
180					0.083 (2.1)			0.118 (3)	0.102 (2.6)								184	
220					0.083 (2.1)			0.118 (3)	0.102 (2.6)								224	
270					0.083 (2.1)			0.118 (3)	0.102 (2.6)					0.098 (2.5)	0.102 (2.6)		274	
330	0.083 (2.1)		0.083 (2.1)		0.083 (2.1)			0.130 (3.3)	0.102 (2.6)					0.098 (2.5)	0.102 (2.6)		334	
390	0.083 (2.1)		0.083 (2.1)		0.083 (2.1)			0.138 (3.5)	0.102 (2.6)					0.098 (2.5)	0.102 (2.6)		394	
470	0.083 (2.1)		0.083 (2.1)		0.083 (2.1)			0.157 (4)	0.102 (2.6)					0.118 (3)	0.102 (2.6)		474	
560	0.083 (2.1)		0.083 (2.1)		0.083 (2.1)			0.169 (4.3)	0.114 (2.9)					0.118 (3)	0.102 (2.6)		564	
680	0.083 (2.1)		0.083 (2.1)		0.098 (2.5)			0.276 (7)	0.134 (3.4)					0.118 (3)	0.102 (2.6)		684	
820	0.083 (2.1)		0.083 (2.1)		0.098 (2.5)	0.079 (2.3)		0.390 (9.9)	0.150 (3.8)				0.118 (3)	0.138 (3.5)	0.102 (2.6)		824	
1 µF	0.083 (2.1)		0.083 (2.1)		0.118 (3)	0.079 (2.3)		0.406 (10.3)	0.245 (6.2)				0.118 (3)	0.165 (4.2)	0.110 (2.8)		105	
1.2	0.083 (2.1)		0.083 (2.1)		0.138 (3.5)	0.079 (2.3)		0.552 (14)	0.245 (6.2)				0.118 (3)	0.102 (2.6)	0.252 (6.4)	0.130 (3.3)	125	
1.5	0.083 (2.1)	0.079 (2.3)	0.083 (2.1)	0.079 (2.3)	0.157 (4)	0.102 (2.6)		0.630 (16)	0.300 (7.6)				0.118 (3)	0.102 (2.6)	0.378 (9.6)	0.142 (3.6)	155	
1.8	0.098 (2.5)	0.079 (2.3)	0.098 (2.5)	0.079 (2.3)	0.233 (5.9)	0.111 (2.8)		0.709 (18)	0.315 (8)	0.098 (2.5)		0.098 (2.5)	0.118 (3)	0.102 (2.6)	0.378 (9.6)	0.157 (4.1)	185	
2.2	0.098 (2.5)	0.079 (2.3)	0.098 (2.5)	0.079 (2.3)	0.252 (6.4)	0.126 (3.2)		0.709 (18)	0.426 (10.8)	0.098 (2.5)		0.098 (2.5)	0.118 (3)	0.102 (2.6)	0.378 (9.6)	0.256 (6.5)	225	
2.7	0.110 (2.8)	0.079 (2.3)	0.110 (2.8)	0.079 (2.3)	0.252 (6.4)	0.142 (3.6)			0.567 (14.4)	0.098 (2.5)		0.098 (2.5)	0.138 (3.5)	0.102 (2.6)	0.504 (12.8)	0.288 (7.3)	275	
3.3	0.110 (2.8)	0.079 (2.3)	0.110 (2.8)	0.079 (2.3)	0.378 (9.6)	0.229 (5.8)		0.630 (16)		0.098 (2.5)	0.102 (2.6)	0.098 (2.5)	0.102 (2.6)	0.157 (4)	0.111 (2.8)	0.583 (14.8)	0.319 (8.1)	335
3.9	0.130 (3.3)	0.079 (2.3)	0.130 (3.3)	0.079 (2.3)	0.378 (9.6)	0.252 (6.4)				0.098 (2.5)	0.102 (2.6)	0.098 (2.5)	0.102 (2.6)	0.252 (6.4)	0.122 (3.1)	0.662 (16.8)	0.438 (11.1)	395
4.7	0.138 (3.5)	0.079 (2.3)	0.138 (3.5)	0.079 (2.3)	0.504 (12.8)	0.284 (7.2)				0.118 (3)	0.102 (2.6)	0.118 (3)	0.102 (2.6)	0.378 (9.6)	0.138 (3.5)		0.449 (11.4)	475
5.6	0.142 (3.6)	0.102 (2.6)	0.142 (3.6)	0.102 (2.6)	0.630 (16)	0.300 (7.6)				0.118 (3)	0.102 (2.6)	0.118 (3)	0.102 (2.6)	0.378 (9.6)	0.221 (5.6)		0.587 (14.9)	565
6.8	0.185 (4.7)	0.118 (3)	0.185 (4.7)	0.118 (3)	0.709 (18)	0.418 (10.6)				0.118 (3)	0.102 (2.6)	0.118 (3)	0.102 (2.6)	0.434 (11)	0.237 (6)		0.658 (16.7)	685
8.2	0.284 (7.2)	0.142 (3.6)	0.284 (7.2)	0.142 (3.6)		0.449 (11.4)				0.138 (3.5)	0.102 (2.6)	0.138 (3.5)	0.102 (2.6)	0.438 (11.1)	0.252 (6.4)			825
10	0.292 (7.4)	0.197 (5)	0.292 (7.4)	0.197 (5)		0.583 (14.8)				0.150 (3.8)	0.102 (2.6)	0.150 (3.8)	0.102 (2.6)	0.497 (12.6)	0.371 (9.4)			106
12	0.414 (10.5)	0.221 (5.6)	0.414 (10.5)	0.221 (5.6)						0.252 (6.4)	0.111 (2.8)	0.252 (6.4)	0.111 (2.8)	0.630 (16)	0.390 (9.9)			126
15	0.438 (11.1)	0.308 (7.8)	0.438 (11.1)	0.308 (7.8)						0.284 (7.2)	0.126 (3.2)	0.319 (8.1)	0.126 (3.2)		0.520 (13.2)			156
18	0.583 (14.8)	0.347 (8.8)	0.583 (14.8)	0.347 (8.8)						0.304 (7.7)	0.221 (5.6)	0.394 (10.8)	0.221 (5.6)		0.567 (14.4)			186
22	0.598 (15.2)	0.402 (10.2)	0.598 (15.2)	0.402 (10.2)						0.315 (8)	0.229 (5.8)	0.504 (12.8)	0.229 (5.8)					226
27		0.441 (11.2)		0.441 (11.2)						0.461 (11.7)	0.245 (6.2)	0.504 (12.8)	0.245 (6.2)					276
33		0.591 (15)		0.591 (15)						0.473 (12)	0.339 (8.6)	0.583 (14.8)	0.339 (8.6)					336
39		0.630 (16)		0.630 (16)						0.630 (16)	0.371 (9.4)	0.662 (16.8)	0.371 (9.4)					396
47											0.473 (12)		0.473 (12)					476
56											0.536 (13.6)		0.536 (13.6)					566

The thickness H max in inches (in mm) for the SC Series or the height T max in inches (in mm) for the SV Series is indicated in the cells.

SC / SV Series

High Capacitance Stacked Capacitors

STANDARD RATINGS

Exxelia size code	6560								6080 / 8060								Cap. code
	SC05 / SV05								SC06 / SC07 - SV06 / SV07								
	50 V		100 V		200 V		500 V		50 V		100 V		200 V		500 V		
Dielectric code	X	T	X	T	X	T	X	T	X	T	X	T	X	T	X	T	
270nf							0.098 (2.5)	0.102 (2.6)									274
330							0.098 (2.5)	0.102 (2.6)									334
390							0.098 (2.5)	0.102 (2.6)									394
470							0.098 (2.5)	0.102 (2.6)							0.118 (3)		474
560					0.098 (2.5)		0.098 (2.5)	0.102 (2.6)							0.118 (3)		564
680					0.098 (2.5)		0.098 (2.5)	0.102 (2.6)							0.118 (3)	0.102 (2.6)	684
820					0.098 (2.5)		0.118 (3)	0.102 (2.6)							0.118 (3)	0.102 (2.6)	824
1 µF	0.098 (2.5)		0.098 (2.5)		0.098 (2.5)	0.102 (2.6)	0.118 (3)	0.102 (2.6)							0.118 (3)	0.102 (2.6)	105
1.2	0.098 (2.5)		0.098 (2.5)		0.098 (2.5)	0.102 (2.6)	0.138 (3.5)	0.102 (2.6)							0.138 (3.5)	0.102 (2.6)	125
1.5	0.098 (2.5)		0.098 (2.5)		0.098 (2.5)	0.102 (2.6)	0.157 (4)	0.118 (3)					0.118 (3)		0.157 (4)	0.102 (2.6)	155
1.8	0.098 (2.5)		0.098 (2.5)		0.098 (2.5)	0.102 (2.6)	0.177 (4.5)	0.118 (3)					0.118 (3)		0.177 (4.5)	0.102 (2.6)	185
2.2	0.098 (2.5)		0.098 (2.5)		0.098 (2.5)	0.102 (2.6)	0.272 (6.9)	0.130 (3.3)					0.118 (3)	0.102 (2.6)	0.272 (6.9)	0.102 (2.6)	225
2.7	0.098 (2.5)	0.102 (2.6)	0.098 (2.5)	0.102 (2.6)	0.118 (3)	0.102 (2.6)	0.312 (7.9)	0.150 (3.8)					0.118 (3)	0.102 (2.6)	0.378 (9.6)	0.130 (3.3)	275
3.3	0.098 (2.5)	0.102 (2.6)	0.098 (2.5)	0.102 (2.6)	0.118 (3)	0.102 (2.6)	0.331 (8.4)	0.169 (4.3)					0.118 (3)	0.102 (2.6)	0.398 (10.1)	0.154 (3.9)	335
3.9	0.098 (2.5)	0.102 (2.6)	0.098 (2.5)	0.102 (2.6)	0.138 (3.5)	0.102 (2.6)	0.438 (11.1)	0.264 (6.7)	0.118 (3)		0.118 (3)		0.138 (3.5)	0.102 (2.6)	0.504 (12.8)	0.173 (4.4)	395
4.7	0.098 (2.5)	0.102 (2.6)	0.098 (2.5)	0.102 (2.6)	0.157 (4)	0.102 (2.6)	0.497 (12.6)	0.296 (7.5)	0.118 (3)		0.118 (3)		0.157 (4)	0.102 (2.6)	0.583 (14.8)	0.249 (6.3)	475
5.6	0.098 (2.5)	0.102 (2.6)	0.098 (2.5)	0.102 (2.6)	0.233 (5.9)	0.114 (2.9)	0.662 (16.8)	0.335 (8.5)	0.118 (3)		0.118 (3)		0.252 (6.4)	0.102 (2.6)	0.583 (14.8)	0.276 (7)	565
6.8	0.098 (2.5)	0.102 (2.6)	0.098 (2.5)	0.102 (2.6)	0.252 (6.4)	0.130 (3.3)	0.819 (20.8)	0.355 (9)	0.118 (3)	0.102 (2.6)	0.118 (3)	0.102 (2.6)	0.252 (6.4)	0.118 (3)	0.661 (16.8)	0.319 (8.1)	685
8.2	0.118 (3)	0.102 (2.6)	0.118 (3)	0.102 (2.6)	0.359 (9.1)	0.150 (3.8)		0.473 (12)	0.118 (3)	0.102 (2.6)	0.118 (3)	0.102 (2.6)	0.378 (9.6)	0.142 (3.6)	0.740 (18.8)	0.386 (9.8)	825
10	0.118 (3)	0.102 (2.6)	0.118 (3)	0.102 (2.6)	0.378 (9.6)	0.233 (5.9)		0.532 (13.5)	0.138 (3.5)	0.102 (2.6)	0.138 (3.5)	0.102 (2.6)	0.378 (9.6)	0.220 (5.6)		0.485 (12.3)	106
12	0.138 (3.5)	0.102 (2.6)	0.138 (3.5)	0.102 (2.6)	0.504 (12.8)	0.260 (6.6)		0.689 (17.5)	0.138 (3.5)	0.102 (2.6)	0.138 (3.5)	0.102 (2.6)	0.504 (12.8)	0.236 (6)		0.595 (15.1)	126
15	0.157 (4)	0.102 (2.6)	0.157 (4)	0.102 (2.6)	0.583 (14.8)	0.296 (7.5)			0.138 (3.5)	0.102 (2.6)	0.138 (3.5)	0.102 (2.6)	0.504 (12.8)	0.276 (7)		0.725 (18.4)	156
18	0.252 (6.4)	0.102 (2.6)	0.252 (6.4)	0.102 (2.6)		0.398 (10.1)			0.146 (3.7)	0.102 (2.6)	0.146 (3.7)	0.102 (2.6)	0.630 (16)	0.347 (8.8)			186
22	0.252 (6.4)	0.118 (3)	0.252 (6.4)	0.118 (3)		0.434 (11)			0.252 (6.4)	0.110 (2.8)	0.291 (7.4)	0.110 (2.8)	0.740 (18.8)	0.362 (9.2)			226
27	0.312 (7.9)	0.142 (3.6)	0.378 (9.6)	0.142 (3.6)		0.552 (14)			0.252 (6.4)	0.130 (3.3)	0.323 (8.2)	0.130 (3.3)	0.740 (18.8)	0.504 (12.8)			276
33	0.331 (8.4)	0.220 (5.6)	0.378 (9.6)	0.220 (5.6)		0.630 (16)			0.280 (7.1)	0.220 (5.6)	0.413 (10.5)	0.220 (5.6)		0.598 (15.2)			336
39	0.457 (11.6)	0.237 (6)	0.504 (12.8)	0.237 (6)					0.378 (9.6)	0.228 (5.8)	0.441 (11.2)	0.228 (5.8)		0.630 (16)			396
47	0.497 (12.6)	0.276 (7)	0.504 (12.8)	0.276 (7)					0.378 (9.6)	0.256 (6.5)	0.465 (11.8)	0.256 (6.5)					476
56	0.662 (16.8)	0.347 (8.8)	0.669 (17)	0.347 (8.8)					0.457 (11.6)	0.347 (8.8)	0.472 (12)	0.347 (8.8)					566
68		0.378 (9.6)		0.378 (9.6)					0.583 (14.8)	0.354 (9)	0.591 (15)	0.354 (9)					686
82		0.504 (12.8)		0.504 (12.8)						0.465 (11.8)		0.465 (11.8)					826
100		0.575 (14.6)		0.575 (14.6)						0.768 (19.5)		0.768 (19.5)					107

The thickness H max in inches (in mm) for the SC Series or the height T max in inches (in mm) for the SV Series is indicated in the cells.

High Capacitance Stacked Capacitors

SC / SV Series

STANDARD RATINGS

Excellia size code	45107								45214				80150				125205				Cap. code
	SC10								SC11				SC12				SC18				
	50 V		100 V		200 V		500 V		50 V	100 V	200 V	500 V	50 V	100 V	200 V	500 V	50 V	100 V	200 V	500 V	
Dielectric code	X	T	X	T	X	T	X	T	X	X	X	X	X	X	X	X	X	X	X	X	
680nf							0.138 (3.5)	0.122 (3.1)													684
820					0.118 (3)	0.118 (3)	0.138 (3.5)	0.122 (3.1)													824
1 µF	0.118 (3)		0.118 (3)		0.118 (3)	0.118 (3)	0.150 (3.8)	0.122 (3.1)													105
1.2	0.118 (3)		0.118 (3)		0.118 (3)	0.118 (3)	0.150 (3.8)	0.122 (3.1)													125
1.5	0.118 (3)	0.118 (3)	0.118 (3)	0.118 (3)	0.118 (3)	0.118 (3)	0.252 (6.4)	0.122 (3.1)													155
1.8	0.118 (3)	0.118 (3)	0.118 (3)	0.118 (3)	0.118 (3)	0.118 (3)	0.252 (6.4)	0.122 (3.1)													185
2.2	0.118 (3)	0.118 (3)	0.118 (3)	0.118 (3)	0.138 (3.5)	0.118 (3)	0.252 (6.4)	0.122 (3.1)													225
2.7	0.118 (3)	0.118 (3)	0.118 (3)	0.118 (3)	0.150 (3.8)	0.118 (3)	0.292 (7.4)	0.122 (3.1)				*							0.157 (4)		275
3.3	0.118 (3)	0.118 (3)	0.118 (3)	0.118 (3)	0.157 (4)	0.118 (3)	0.378 (9.6)	0.331 (8.4)				*							0.157 (4)		335
3.9	0.118 (3)	0.118 (3)	0.118 (3)	0.118 (3)	0.213 (5.4)	0.118 (3)	0.504 (12.8)	0.331 (8.4)				*							0.157 (4)		395
4.7	0.118 (3)	0.118 (3)	0.118 (3)	0.118 (3)	0.233 (5.9)	0.118 (3)	0.583 (14.8)	0.331 (8.4)				*							0.157 (4)		475
5.6	0.118 (3)	0.118 (3)	0.118 (3)	0.118 (3)	0.252 (6.4)	0.118 (3)	0.583 (14.8)	0.331 (8.4)				*							0.315 (8)		565
6.8	0.118 (3)	0.118 (3)	0.118 (3)	0.118 (3)	0.319 (8.1)	0.252 (6.4)	0.662 (16.8)	0.331 (8.4)				*							0.315 (8)		685
8.2	0.118 (3)	0.118 (3)	0.118 (3)	0.118 (3)	0.378 (9.6)	0.252 (6.4)		0.496 (12.6)				*	*					0.157 (4)	0.315 (8)		825
10	0.138 (3.5)	0.118 (3)	0.138 (3.5)	0.118 (3)	0.378 (9.6)	0.252 (6.4)		0.496 (12.6)				*	*					0.157 (4)	0.315 (8)		106
12	0.138 (3.5)	0.118 (3)	0.138 (3.5)	0.118 (3)	0.504 (12.8)	0.378 (9.6)		0.661 (16.8)			*	*	*					0.315 (8)	0.472 (12)		126
15	0.252 (6.4)	0.118 (3)	0.252 (6.4)	0.118 (3)	0.504 (12.8)	0.378 (9.6)					*	*						0.315 (8)	0.472 (12)		156
18	0.252 (6.4)	0.118 (3)	0.252 (6.4)	0.118 (3)	0.661 (16.8)	0.504 (12.8)					*	*			*			0.315 (8)	0.630 (16)		186
22	0.378 (9.6)	0.118 (3)	0.378 (9.6)	0.118 (3)		0.504 (12.8)					*	*			*			0.315 (8)	*		226
27	0.378 (9.6)	0.130 (3.3)	0.378 (9.6)	0.130 (3.3)		0.661 (16.8)				*	*	*			*			0.472 (12)	*		276
33	0.504 (12.8)	0.276 (7)	0.504 (12.8)	0.276 (7)						*	*	*					0.157 (4)	0.472 (12)	*		336
39	0.504 (12.8)	0.276 (7)	0.504 (12.8)	0.276 (7)						*	*				0.157 (4)	0.157 (4)	0.630 (16)			*	396
47	0.591 (15)	0.276 (7)	0.591 (15)	0.276 (7)						*	*				0.157 (4)	0.315 (8)	*			*	476
56	0.591 (15)	0.433 (11)	0.591 (15)	0.433 (11)						*	*				0.315 (8)	0.315 (8)	*			*	566
68		0.433 (11)		0.433 (11)						*	*				0.315 (8)	0.315 (8)				*	686
82		0.591 (15)		0.591 (15)						*					0.315 (8)	0.315 (8)			*	*	826
100										*					0.315 (8)	0.472 (12)			*	*	107
120										*					0.472 (12)	0.472 (12)			*	*	127
150															0.472 (12)	0.630 (16)			*	*	157
180															0.630 (16)				*	*	187
220																			*	*	227
270																			*		277
330																			*		337
390																			*		397

The thickness H max in inches (in mm) for the SC Series or the height T max in inches (in mm) for the SV Series is indicated in the cells. * Consult us

CNC3X Series

High Capacitance Stacked Capacitors



ESA Qualified
 Available space ranges:
 consult our detail
 specifications

FEATURES

- Multilayer chips ceramic capacitors stacked
- X7R dielectric (NP0 available on request)
- Capacitance range: 1.2µF to 68µF
- Voltage range: 16 V_{DC} to 25 V_{DC}
- Their low operating voltage give them a major advantage as they have much higher capacitance values in the same format. These components are ideally suited to advanced digital electronic applications requiring ever lower operating voltages

PHYSICAL CHARACTERISTICS

CONSTRUCTION

- P, PL, L models: DIL leaded uncoated stacked chips capacitors for surface mounting recommended to eliminate thermomechanical stresses.
- N, NU models: DIL leaded stacked chips capacitors for through-hole circuits (N: varnished, NU: uncoated chips)
- They can be supplied on request in ribbon or molded configuration

MARKING (clear or coded)

Capacitance value, tolerance, rated voltage (except 16 V).

ELECTRICAL SPECIFICATIONS

DIELECTRIC	X7R
Maximum ΔC/°C over temperature range without voltage	±15%
Ageing	≤ 2.5% per decade hour
Operating temperature	-55°C +125°C
Rated voltage (U _{RC})	16 V _{DC} to 25 V _{DC}
Dielectric withstanding voltage	2.5 U _{RC}
Capacitance	at 1kHz 0.3Vrms
Dissipation factor	≤2.5% at 1kHz 0.3Vrms
Insulation resistance at 25°C under U _{RC}	≥ 1,000 MΩµF

HOW TO ORDER

CNC	33	P	W	F	6,8µF	±10%	25 V
Series	Exxelia size code	Model	RoHS Compliant	Quality level	Capacitance	Tolerance	Rated voltage
CNC	31 32 33 34	P PL L N NU	- = No RoHS W = RoHS compliant	- = standard quality level F = Hi-Rel quality: screening in accordance with Exxelia specification	Capacitance value in clear	±10% ±20%	16 V 25 V

High Capacitance Stacked Capacitors

CNC3X Series

DIMENSIONS in inches (mm)

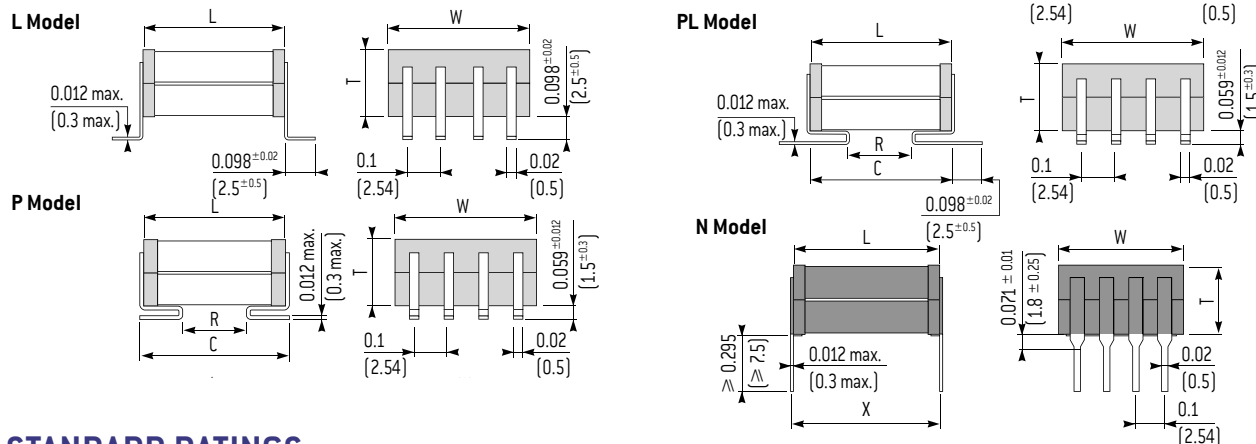

STANDARD RATINGS

Size	Series	Dimensions inches (mm)					Leads per side	T max.		Nb. of chips	Rated Voltage		Min. cap. Value	
		L max.	W max.	R min.	C max.	X		inches	(mm)		16 V	25 V		
2220	CNC31	0.296	0.237	0.098	0.296	0.2 ± 0.020	2	0.099	(2.5)	1	3.9µF	2.2µF	1.2µF	
		(7.5)	(6)	(2.5)	(7.5)	(5.08 ± 0.5)		0.197	(5)		2	6.8µF		4.7µF
								0.296	(7.5)		3	12µF		6.8µF
2528	CNC32	0.315	0.315	0.098	0.315	0.3 ± 0.020	3	0.099	(2.5)	1	4.7µF	3.3µF	1.8µF	
		(8)	(8)	(2.5)	(8)	(7.62 ± 0.5)		0.197	(5)		2	10µF		5.6µF
								0.296	(7.5)		3	15µF		10µF
3333	CNC33	0.394	0.363	0.137	0.394	0.3 ± 0.020	3	0.099	(2.5)	1	8.2µF	5.6µF	3.3µF	
		(10)	(9.2)	(3.5)	(10)	(7.62 ± 0.5)		0.197	(5)		2	15µF		10µF
								0.296	(7.5)		3	22µF		15µF
								0.394	(10)		4	33µF		22µF
4040	CNC34	0.493	0.473	0.196	0.493	0.4 ± 0.020	4	0.099	(2.5)	1	15µF	10µF	5.6µF	
		(12.5)	(12)	(5)	(12.5)	(10.16 ± 0.5)		0.197	(5)		2	27µF		18µF
								0.296	(7.5)		3	47µF		27µF
								0.394	(10)		4	68µF		39µF

Available capacitance values: E6, E12 (see page 14). Specific values upon request.

The above table defines the standard products, other components may be built upon request.

RECOMMENDED FOOTPRINT

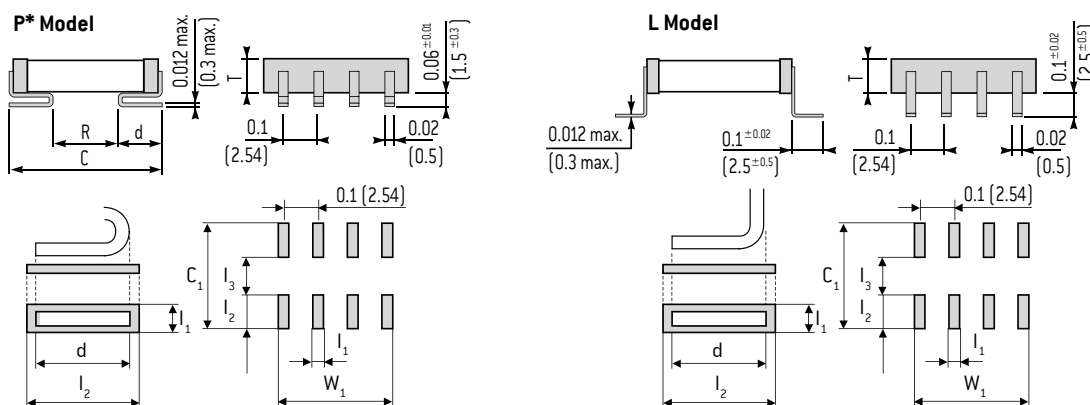

Exxelia size code	Lead shape	C max inches (mm)	Leads per side	d inches (mm)	C ₁ inches (mm)	W ₁ inches (mm)	I ₁ inches (mm)	I ₂ inches (mm)	I ₃ inches (mm)
31	P*	0.295 (7.5)	2	0.059 ± 0.012 (1.5 ± 0.3)	0.335 (8.5)	0.147 (3.74)	0.047 (1.2)	0.128 (3.25)	0.079 (2)
	L	0.512 (13)	2	0.098 ± 0.02 (2.5 ± 0.5)	0.551 (14)	0.147 (3.74)	0.047 (1.2)	0.187 (4.75)	0.177 (4.5)
32	P*	0.315 (8)	3	0.087 ± 0.012 (2.2 ± 0.3)	0.354 (9)	0.247 (6.28)	0.047 (1.2)	0.138 (3.5)	0.079 (2)
	L	0.531 (13.5)	3	0.098 ± 0.02 (2.5 ± 0.5)	0.571 (14.5)	0.247 (6.28)	0.047 (1.2)	0.187 (4.75)	0.197 (5)
33	P*	0.394 (10)	3	0.087 ± 0.012 (2.2 ± 0.3)	0.433 (11)	0.247 (6.28)	0.047 (1.2)	0.157 (4)	0.118 (3)
	L	0.610 (15.5)	3	0.098 ± 0.02 (2.5 ± 0.5)	0.650 (16.5)	0.247 (6.28)	0.047 (1.2)	0.187 (4.75)	0.276 (7)
34	P*	0.492 (12.5)	4	0.087 ± 0.012 (2.2 ± 0.3)	0.531 (13.5)	0.347 (8.82)	0.047 (1.2)	0.177 (4.5)	0.177 (4.5)
	L	0.709 (18)	4	0.098 ± 0.02 (2.5 ± 0.5)	0.748 (19)	0.347 (8.82)	0.047 (1.2)	0.187 (4.75)	0.374 (9.5)

* For PL : add 0.098 in (2.5 mm) to d and I₂ and 0.197 in (5 mm) to C₁.

CEC5X Series

High Capacitance Stacked Capacitors



According to
Available space ranges:
consult our detail
specifications

FEATURES

- Multilayer chips ceramic capacitors
- NPO dielectric
- Capacitance range: 10nF to 6.8 μ F
- Voltage range: 63 V_{DC} to 500 V_{DC}

PHYSICAL CHARACTERISTICS

CONSTRUCTION

- P, PL, L models: DIL leaded uncoated stacked chips capacitors for surface mounting recommended to eliminate thermomechanical stresses.
- N, NU models: DIL leaded stacked chips capacitors for through-hole circuits (N: varnished, NU: uncoated chips)
- They can be supplied on request in ribbon connection configuration ideally suited to iron soldering

MARKING (clear or coded)

Series, Capacitance value, tolerance, rated voltage, date code.

ELECTRICAL SPECIFICATIONS

DIELECTRIC	NPO
Maximum $\Delta C/^\circ C$ over temperature range without voltage	NA
Temperature coefficient	(0 \pm 30)ppm/ $^\circ C$
Ageing	None
Operating temperature	-55 $^\circ C$ to +125 $^\circ C$
Rated voltage (U _{RC})	63 V _{DC} to 500 V _{DC}
Dielectric withstanding voltage	2.5 U _{RC} for U _{RC} < 500 V _{DC} 2 U _{RC} for U _{RC} = 500 V _{DC}
Capacitance	at 1kHz
Dissipation factor	\leq 0.15% at 1kHz
Insulation resistance at 25 $^\circ C$ under U _{RC}	\geq 1,000 M $\Omega \mu$ F

HOW TO ORDER

CEC	53	P	W	F	120nF	\pm 10%	200 V
Series	Exxelia size code	Model	RoHS compliant	Quality level	Capacitance	Tolerance	Rated voltage
CEC	53 54 55 56 57 58 65	P PL L N NU	- = No RoHS W = RoHS compliant	- = standard quality level F = Hi-Rel quality: screening in accordance with Exxelia specification	Capacitance value in clear	\pm 1% \pm 2% \pm 5% \pm 10% \pm 20%	63V 100V 200V 500V

RECOMMENDED FOOTPRINT

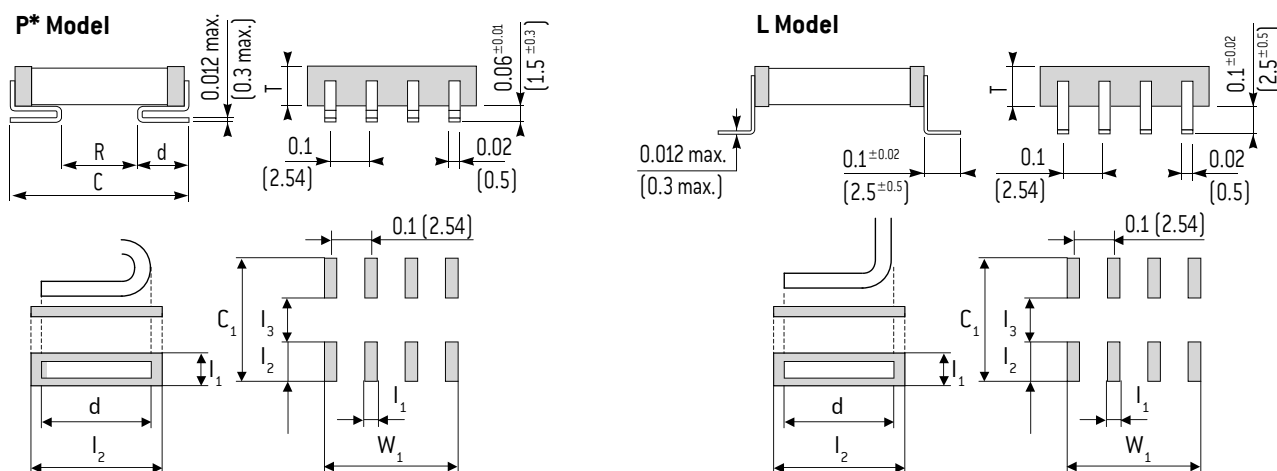

Exxelia size code	Lead shape	C max		Leads per side	d		C ₁		W ₁		l ₁		l ₂		l ₃	
		inches	(mm)		inches	(mm)	inches	(mm)	inches	(mm)	inches	(mm)	inches	(mm)	inches	(mm)
53	P*	0.354	[9]	3	0.087 ± 0.012	{2.2 ± 0.3}	0.394	[10]	0.247	[6.28]	0.047	[1.2]	0.146	[3.7]	0.102	[2.6]
	L	0.579	[14.7]	3	0.098 ± 0.02	{2.5 ± 0.5}	0.618	[15.7]	0.247	[6.28]	0.047	[1.2]	0.167	[4.25]	0.283	[7.2]
54	P*	0.472	[12]	4	0.087 ± 0.012	{2.2 ± 0.3}	0.512	[13]	0.347	[8.82]	0.047	[1.2]	0.187	[4.75]	0.138	[3.5]
	L	0.656	[16.66]	4	0.098 ± 0.02	{2.5 ± 0.5}	0.695	[17.66]	0.347	[8.82]	0.047	[1.2]	0.167	[4.25]	0.361	[9.16]
55	P*	0.587	[14.9]	5	0.087 ± 0.012	{2.2 ± 0.3}	0.626	[15.9]	0.447	[11.36]	0.047	[1.2]	0.175	[4.45]	0.276	[7]
	L	0.807	[20.5]	5	0.098 ± 0.02	{2.5 ± 0.5}	0.846	[21.5]	0.447	[11.36]	0.047	[1.2]	0.167	[4.25]	0.512	[13]
56	P*	0.661	[16.8]	7	0.087 ± 0.012	{2.2 ± 0.3}	0.701	[17.8]	0.647	[16.44]	0.047	[1.2]	0.163	[4.15]	0.374	[9.5]
	L	0.856	[21.74]	7	0.098 ± 0.02	{2.5 ± 0.5}	0.895	[22.74]	0.647	[16.44]	0.047	[1.2]	0.167	[4.25]	0.561	[14.24]
57	P*	0.472	[12]	14	0.087 ± 0.012	{2.2 ± 0.3}	0.512	[13]	1.347	[34.22]	0.047	[1.2]	0.163	[4.15]	0.185	[4.7]
	L	0.656	[16.66]	14	0.098 ± 0.02	{2.5 ± 0.5}	0.695	[17.66]	1.347	[34.22]	0.047	[1.2]	0.167	[4.25]	0.361	[9.16]
58	P*	0.945	[24]	14	0.087 ± 0.012	{2.2 ± 0.3}	0.984	[25]	1.347	[34.22]	0.047	[1.2]	0.163	[4.15]	0.657	[16.7]
	L	1.056	[26.82]	14	0.098 ± 0.02	{2.5 ± 0.5}	1.095	[27.82]	1.347	[34.22]	0.047	[1.2]	0.167	[4.25]	0.761	[19.32]
65	P*	0.850	[21.6]	6	0.087 ± 0.012	{2.2 ± 0.3}	0.890	[22.6]	0.547	[13.9]	0.047	[1.2]	0.163	[4.15]	0.563	[14.3]
	L	1.056	[26.82]	6	0.098 ± 0.02	{2.5 ± 0.5}	1.095	[27.82]	0.547	[13.9]	0.047	[1.2]	0.167	[4.25]	0.761	[19.32]

* For PL : add 0.098 in [2.5 mm] to d and l₂ and 0.197 in [5 mm] to C₁.

HIGH CAPACITANCE

CEC5X Series

High Capacitance Stacked Capacitors

DIMENSIONS in inches (mm)

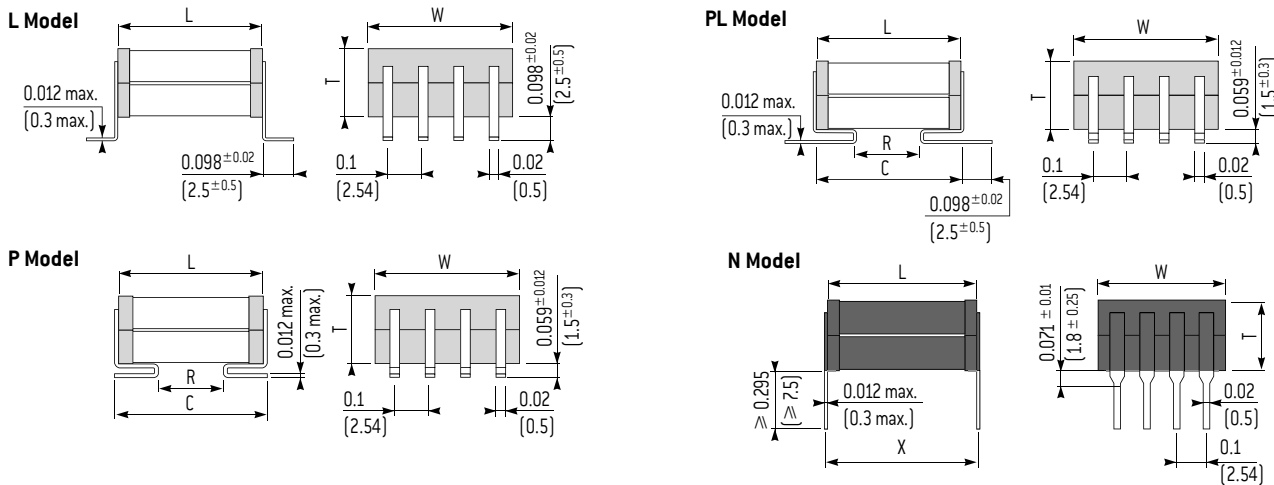

STANDARD RATINGS

Size	3033	3740	5550	6080	40140	80150	8060			
Exxelia size code	53	54	55	56	57	58	65			
L max.	0.355 (9)	0.473 (12)	0.587 (14.9)	0.662 (16.8)	0.473 (12)	0.945 (24)	0.851 (21.6)			
W max.	0.363 (9.2)	0.453 (11.5)	0.536 (13.6)	0.851 (21.6)	1.504 (38.2)	1.599 (40.6)	0.654 (16.6)			
R min.	0.122 (3.1)	0.204 (5.2)	0.295 (7.5)	0.393 (10)	0.204 (5.2)	0.649 (16.5)	0.582 (14.8)			
C max.	0.355 (9)	0.473 (12)	0.587 (14.9)	0.662 (16.8)	0.473 (12)	0.945 (24)	0.851 (21.6)			
X	0.3 ± 0.02 (7.62 ± 0.5)	0.4 ± 0.02 (10.16 ± 0.5)	0.551 ± 0.02 (14 ± 0.5)	0.6 ± 0.02 (15.24 ± 0.5)	0.4 ± 0.02 (10.16 ± 0.5)	0.8 ± 0.02 (20.32 ± 0.5)	0.8 ± 0.02 (20.32 ± 0.5)			
Leads per side	3	4	5	7	14	14	6			
Dimensions inches (mm)	Min. Capacitance value	10nF	18nF	33nF	68nF	100nF	150nF	68nF	T max. inches (mm)	Nb. of chips
	63 V	100nF	180nF	330nF	680nF	820nF	1.8µF	680nF	0.158 (4)	1
Rated voltage (U _{RC})	63 V	220nF	330nF	560nF	1.2µF	1.5µF	3.3µF	1.2µF	0.315 (8)	2
		330nF	470nF	820nF	1.8µF	2.2µF	4.7µF	1.8µF	0.473 (12)	3
		470nF	680nF	1.2µF	2.7µF	3.3µF	6.8µF	2.7µF	0.630 (16)	4
		100 V	82nF	120nF	220nF	470nF	560nF	1.2µF	470nF	0.158 (4)
	100 V	180nF	270nF	470nF	1µF	1.2µF	2.7µF	1µF	0.315 (8)	2
		270nF	390nF	680nF	1.5µF	1.8µF	3.9µF	1.5µF	0.473 (12)	3
		330nF	470nF	1µF	1.8µF	2.2µF	4.7µF	1.8µF	0.630 (16)	4
		200 V	56nF	82nF	180nF	330nF	390nF	820nF	330nF	0.158 (4)
	200 V	120nF	180nF	330nF	680nF	820nF	1.5µF	680nF	0.315 (8)	2
		180nF	270nF	470nF	1µF	1.2µF	2.7µF	1µF	0.473 (12)	3
		220nF	330nF	680nF	1.2µF	1.5µF	3.3µF	1.2µF	0.630 (16)	4
		500 V	18nF	27nF	56nF	100nF	150nF	270nF	100nF	0.158 (4)
500 V	33nF	56nF	120nF	220nF	270nF	560nF	220nF	0.315 (8)	2	
	56nF	100nF	180nF	330nF	390nF	820nF	330nF	0.473 (12)	3	
	68nF	120nF	220nF	390nF	470nF	1.2µF	390nF	0.630 (16)	4	

Available capacitance values:
 NPO dielectric: E6, E12, E24 (see page 14). Specific values upon request.
 The above table defines the standard products, other components may be built upon request.



FEATURES

- Multilayer chips ceramic capacitors
- NPO dielectric
- Capacitance range: 10nF to 2.7µF
- Voltage range: 63 V_{DC} to 500 V_{DC}

PHYSICAL CHARACTERISTICS

CONSTRUCTION

Radial leaded varnished stacked chips capacitors for through-hole circuits

MARKING (clear or coded)

Series, Capacitance value, tolerance, rated voltage, date code.

ELECTRICAL SPECIFICATIONS

DIELECTRIC	NPO
Maximum ΔC/°C over temperature range without voltage	NA
Temperature coefficient	(0±30)ppm/°C
Ageing	None
Operating temperature	-55°C to +125°C
Rated voltage (U _{RC})	63 V _{DC} to 500 V _{DC}
Dielectric withstanding voltage	2.5 U _{RC} for U _{RC} < 500 V _{DC} 2 U _{RC} for U _{RC} = 500 V _{DC}
Capacitance	at 1kHz
Dissipation factor	≤ 0.15% at 1kHz
Insulation resistance at 25°C under U _{RC}	≥ 1,000 MΩ·µF

HIGH CAPACITANCE

HOW TO ORDER

TEP	53	W	F	120nF	±10%	200 V
Series	Exxelia size code	RoHS compliant	Quality level	Capacitance	Tolerance	Rated voltage
TEP = radial leads vertical stack	53 54 55 56	- = No RoHS W = RoHS compliant	- = standard quality level F = Hi-Rel quality: screening in accordance with Exxelia specification	Capacitance value in clear	±1% ±2% ±5% ±10% ±20%	63V 100V 200V 500V
TEV = radial leads horizontal stack	57 58 65					

TEP / TEV Series

High Capacitance Stacked Capacitors

DIMENSIONS in inches (mm)

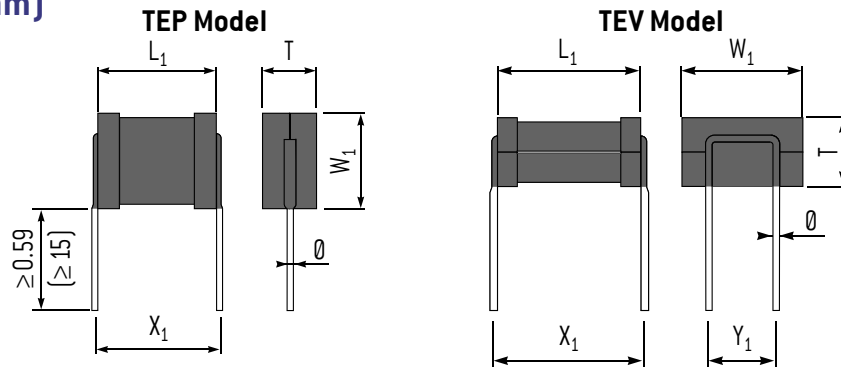

STANDARD RATINGS

Size	3033	3740	5550	6080	40140	80150	8060			
Exxelia size code	53	54	55	56	57	58	65			
Dimensions inches (mm)	L ₁ max.	0.418 (10.6)	0.493 (12.5)	0.623 (15.8)	0.701 (17.8)	0.556 (14.1)	0.894 (22.7)	0.894 (22.7)		
	W ₁ max.	0.363 (9.2)	0.473 (12)	0.536 (13.6)	0.851 (21.6)	1.504 (38.2)	1.599 (40.6)	0.654 (16.6)		
	X ₁ max.	0.323 ± 0.02 (8.2 ± 0.5)	0.4 ± 0.02 (10.16 ± 0.5)	0.579 ± 0.02 (14.7 ± 0.5)	0.6 ± 0.02 (15.24 ± 0.5)	0.4 ± 0.02 (10.16 ± 0.5)	0.835 ± 0.02 (21.2 ± 0.5)	0.835 ± 0.02 (21.2 ± 0.5)		
	Y ₁ max.	0.2 ± 0.02 (5.08 ± 0.5)	0.3 ± 0.02 (7.62 ± 0.5)	0.3 ± 0.02 (7.62 ± 0.5)	0.6 ± 0.02 (15.24 ± 0.5)	1.1 ± 0.02 (27.94 ± 0.5)	1.2 ± 0.02 (30.48 ± 0.5)	0.4 ± 0.02 (10.16 ± 0.5)		
Leads diameter Ø		See table below								
Min. Capacitance value	10nF	18nF	33nF	68nF	100nF	150nF	68nF	T max. inches (mm)	Nb. of chips	
Rated voltage (U _{rated})	63 V	100nF	180nF	330nF	680nF	820nF	1.8µF	680nF	0.158 (4)	1
		220nF	330nF	560nF	1.2µF	1.5µF	3.3µF	1.2µF	0.315 (8)	2
		330nF	470nF	820nF	1.8µF	2.2µF	4.7µF	1.8µF	0.473 (12)	3
		470nF	680nF	1.2µF	2.7µF	3.3µF	6.8µF	2.7µF	0.630 (16)	4
	100 V	82nF	120nF	220nF	470nF	560nF	1.2µF	470nF	0.158 (4)	1
		180nF	270nF	470nF	1µF	1.2µF	2.7µF	1µF	0.315 (8)	2
		270nF	390nF	680nF	1.5µF	1.8µF	3.9µF	1.5µF	0.473 (12)	3
		330nF	470nF	1µF	1.8µF	2.2µF	4.7µF	1.8µF	0.630 (16)	4
	200 V	56nF	82nF	180nF	330nF	390nF	820nF	330nF	0.158 (4)	1
		120nF	180nF	330nF	680nF	820nF	1.5µF	680nF	0.315 (8)	2
		180nF	270nF	470nF	1µF	1.2µF	2.7µF	1µF	0.473 (12)	3
		220nF	330nF	680nF	1.2µF	1.5µF	3.3µF	1.2µF	0.630 (16)	4
	500 V	18nF	27nF	56nF	100nF	150nF	270nF	100nF	0.158 (4)	1
		33nF	56nF	120nF	220nF	270nF	560nF	220nF	0.315 (8)	2
		56nF	100nF	180nF	330nF	390nF	820nF	330nF	0.473 (12)	3
		68nF	120nF	220nF	390nF	470nF	1.2µF	390nF	0.630 (16)	4

Available capacitance values:
 NPO dielectric: E6, E12, E24 (see page 14). Specific values upon request.
 The above table defines the standard products, other components may be built upon request.

T max.	TEP 53 - TEP 54 - TEP 55	TEP 56 - TEP 65	TEV 53	TEV 54 - TEV 55 - TEV 56 - TEV 65
	Leads diameter Ø [±10%] inches (mm)			
4	0.024 (0.6)	0.031 (0.8)	0.031 (0.8)	0.039 (1)
8	0.024 (0.6)	0.031 (0.8)	0.031 (0.8)	0.039 (1)
12	0.031 (0.8)	0.039 (1)	0.031 (0.8)	0.039 (1)
16	0.031 (0.8)	0.039 (1)	0.031 (0.8)	0.039 (1)

High Capacitance Molded Stacked Capacitors

TCN8X Series

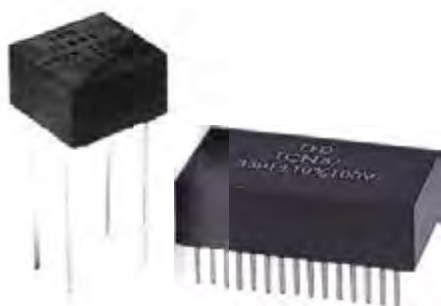

FEATURES

- Multilayer stacked ceramic capacitors
- Epoxy resin molding
- X7R dielectric
- Capacitance range: 470nF to 120µF
- Voltage range: 50 V_{DC} to 500 V_{DC}

PHYSICAL CHARACTERISTICS

CONSTRUCTION

- TCN83/TCN86: epoxy molded (thermal and mechanical protection) capacitors with four radial leads to guarantee enhanced mechanical resistance after mounting
- TCN87: epoxy molded (thermal and mechanical protection) capacitors with DIL leads

MARKING

Series, Capacitance value, tolerance, rated voltage, date code.

ELECTRICAL SPECIFICATIONS

DIELECTRIC	X7R
Maximum ΔC/°C over temperature range without voltage	≤ 20%
Operating temperature	-55°C +125°C
Rated voltage (U _{RC})	50 V _{DC} to 500 V _{DC}
Dielectric withstanding voltage	2 U _{RC}
Capacitance	at 1kHz 0.3 Vrms
Dissipation factor	≤ 2.5% at 1kHz 0.3 Vrms
Insulation resistance at 25°C under U _{RC}	≥ 500 MΩ.µF

HIGH CAPACITANCE

HOW TO ORDER

TCN83	3	W	F	10µF	10%	100 V
Series	Exxelia size code	RoHS compliant	Quality level	Capacitance	Tolerance	Rated voltage
TCN83 TCN86 TCN87	Only for TCN83 and TCN86: 1 2 3 4 5	- = No RoHS W = RoHS compliant	- = standard quality level F = Hi-Rel quality: screening in accordance with Exxelia specification	Capacitance value in clear	±10% ±20%	50 V 100 V 200 V 500 V

TCN8X Series

High Capacitance Molded Stacked Capacitors

DIMENSIONS in inches (mm)

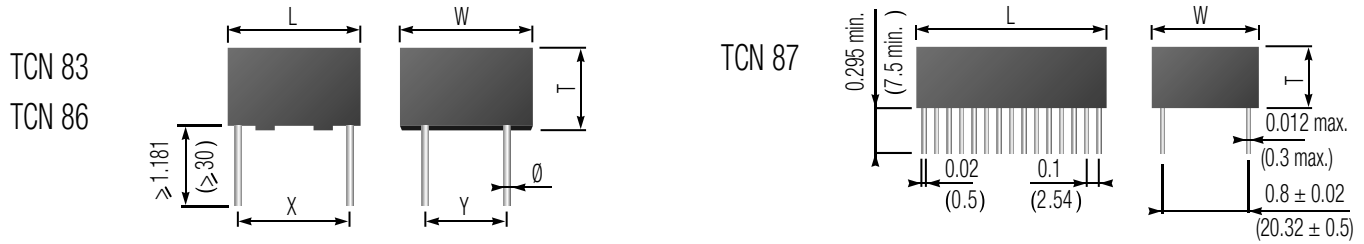

STANDARD RATINGS

Series		TCN83	TCN86	TCN83	TCN86	TCN83	TCN86	TCN83	TCN86	TCN83	TCN86	TCN87	
Case		1	1	2	2	3	3	4	4	5	5	-	
Dimensions inches (mm)	L	±0.02 (±0.5)	0.787 (20)	0.787 (20)	0.787 (20)	0.787 (20)	0.787 (20)	0.787 (20)	0.787 (20)	0.787 (20)	0.787 (20)	1.673 (42.5)	
	W	±0.02 (±0.5)	0.748 (19)	0.787 (20)	0.748 (19)	0.787 (20)	0.748 (19)	0.787 (20)	0.748 (19)	0.787 (20)	0.748 (19)	0.906 (23)	
	X	±0.02 (±0.5)	0.701 (17.8)	0.600 (15.24)	0.701 (17.8)	0.600 (15.24)	0.701 (17.8)	0.600 (15.24)	0.701 (17.8)	0.600 (15.24)	0.701 (17.8)	0.600 (15.24)	-
	Y	±0.02 (±0.5)	0.400 (10.16)	0.500 (12.7)	0.400 (10.16)	0.500 (12.7)	0.400 (10.16)	0.500 (12.7)	0.400 (10.16)	0.500 (12.7)	0.400 (10.16)	0.500 (12.7)	-
	T	0 ± 10%	0.256 max (6.5 max)	0.315 max (8 max)	0.315 max (8 max)	0.493 max (12.5 max)	0.493 max (12.5 max)	0.788 max (20 max)	0.788 max (20 max)	1.182 max (30 max)	1.182 max (30 max)	0.492±0.02 (12.5±0.5)	-
Rated voltage (U _{RC})	Min. Capacitance value		0.47µF	0.56µF	0.56µF	1.8µF	1.8µF	3.3µF	3.3µF	5.6µF	5.6µF	2.2µF	
	63 V	Standard	12µF	12µF	18µF	18µF	27µF	27µF	68µF	68µF	100µF	100µF	100µF
		Extended	18µF	18µF	27µF	27µF	47µF	39µF	82µF	82µF	120µF	120µF	120µF
	100 V	Standard	4.7µF	4.7µF	6.8µF	6.8µF	15µF	15µF	27µF	27µF	39µF	39µF	56µF
		Extended	15µF	5.6µF	18µF	10µF	47µF	18µF	56µF	33µF	47µF	47µF	68µF
	200 V	Standard	1.5µF	1.5µF	2.2µF	2.2µF	3.9µF	3.9µF	8.2µF	8.2µF	15µF	15µF	15µF
		Extended	3.3µF	2.7µF	6.8µF	3.9µF	12µF	6.8µF	12µF	12µF	18µF	18µF	22µF
	400V	Extended	1.5µF	-	1.8µF	-	4.7µF	-	6.8µF	-	8.2µF	-	-
		Standard	0.82µF	0.82µF	1.5µF	1.5µF	2.7µF	2.7µF	4.7µF	4.7µF	6.8µF	6.8µF	8.2µF
	500 V	Standard	0.82µF	0.82µF	1.5µF	1.5µF	2.7µF	2.7µF	4.7µF	4.7µF	6.8µF	6.8µF	8.2µF
Extended		1.5µF	1.5µF	1.8µF	1.8µF	3.3µF	3.3µF	5.6µF	5.6µF	8.2µF	8.2µF	12µF	

Available capacitance values: E6, E12 (see page 14). Specific values upon request.
The above table defines the standard products, other components may be built upon request.

ELECTRICAL EQUIVALENT CIRCUITS

TCN 83

Standard version to be used for usual applications.

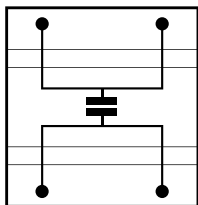

TCN 86

Version featuring particular electrode geometry (crossed electrodes) allowing, compared to TCN 83, to achieve:

- lower series resistance RS
- higher permissible rms. current
- higher resonance frequency

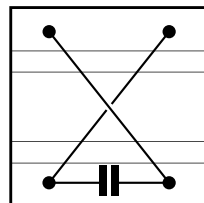

The total use of the the crossed four pole design allows operation at a higher operating frequency and reduces noise due to switching (lower self inductance) for a given capacitance value (see figures on the right).

TCN 87

The use of DIL connections and the general «line shape» of the capacitor provide for:

- easy placement
- very high permissible rms currents
- suppression of switching noise

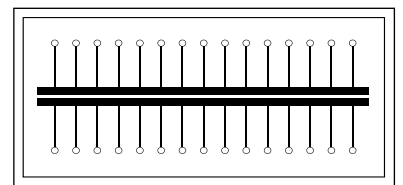

Figures on the right show the outstanding performance of these components in terms of impedance and series resistance.

HIGH TEMPERATURE

GENERAL INFORMATION 104

CE / CN SERIES

High Temperature Chips Capacitors 106

SCT SERIES

High Temperature Stacked Capacitors 108

TCE / TCN MOLDED SERIES HT

High Temperature Molded Capacitors 113

TCE / TCN SELF-PROTECTED SERIES

High Temperature Self-Protected Capacitors 115

TCH SERIES

High Temperature / High Voltage Capacitors 117

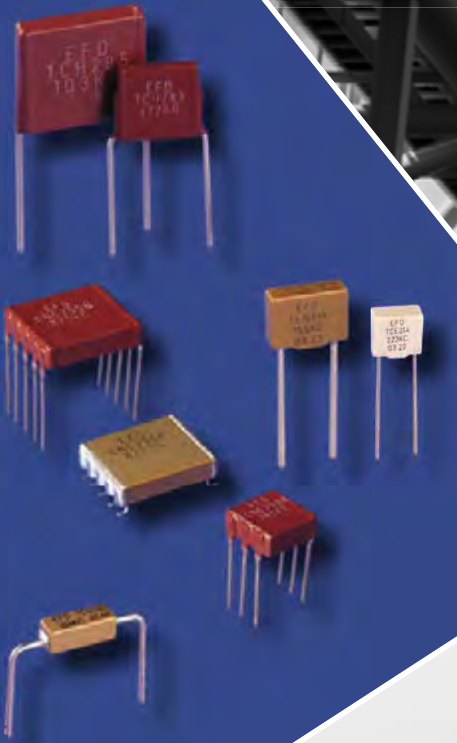

General Information

High temperature capacitors are made of class 1 or class 2 ceramic dielectrics featuring special compositions based upon high purity oxides to reduce ionic conduction inherent to the presence of atoms such as sodium.

In addition, all quality controls carried out at intermediate and final production stages (lot acceptance test under U_{RC} and insulation resistance measurement at operating temperature) are the assurance of enhanced reliability.

High temperature capacitors include :

- chip class 1 (CEC 203 to CEC 233) and class 2 (CNC 203 to 233),
- encapsulated radial leads class 1 and 2 (TCE / TCN 201 to 204),
- encapsulated axial leads class 1 and 2 (TCE / TCN 252 to 254),
- selfprotected radial leads class 1 and 2 (TCE / TCN 212 to 216) and radial leads class 1 and 2 (TCE / TCN 263).

Mechanical stress is eliminated with replacement of epoxy by selfprotected ceramic. This also allows the increase of the capacitance ranges and improves the reliability.

- high voltage varnished capacitors (TCH 279 to 285)
- high capacitance value SCT Series.

They are highly recommended for operation at temperatures of up to 200°C. Capacitors specifically designed for higher operating temperatures (e.g. TCE / TCN 212 to 216 and TCE / TCN 263 to 266) are also available.

High temperature capacitors are made of class 1 or class 2 ceramic dielectrics featuring special compositions based upon high purity oxides to reduce ionic conduction inherent to the presence of atoms such as sodium.

TYPICAL CURVES: CE / CN Series, TCE / TCN Series, TCH Series

NPO: TYPICAL CAPACITANCE VARIATION VERSUS TEMPERATURE

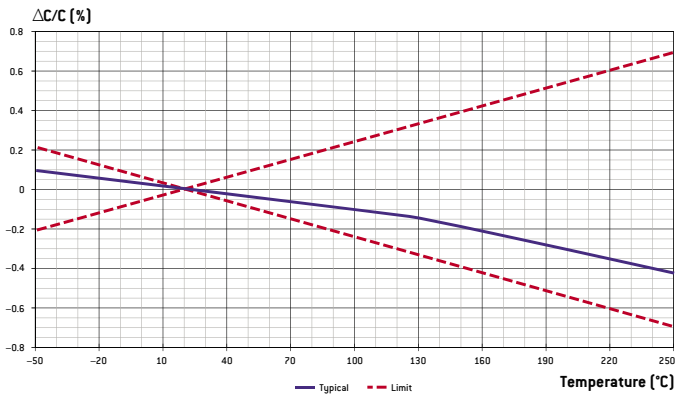

NPO: TYPICAL INSULATION RESISTANCE VERSUS TEMPERATURE

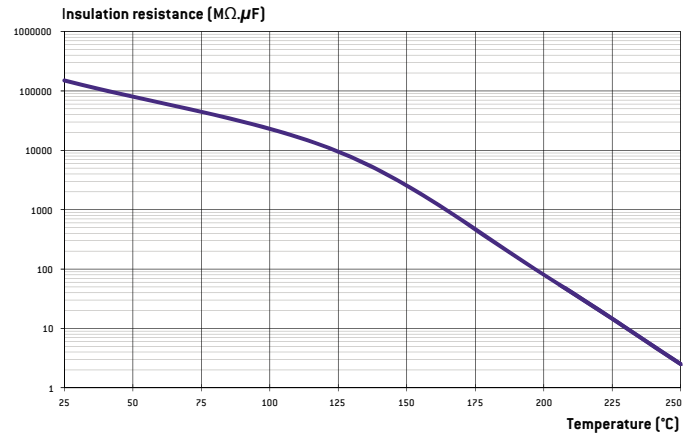

X7R: TYPICAL CAPACITANCE VARIATION VERSUS TEMPERATURE

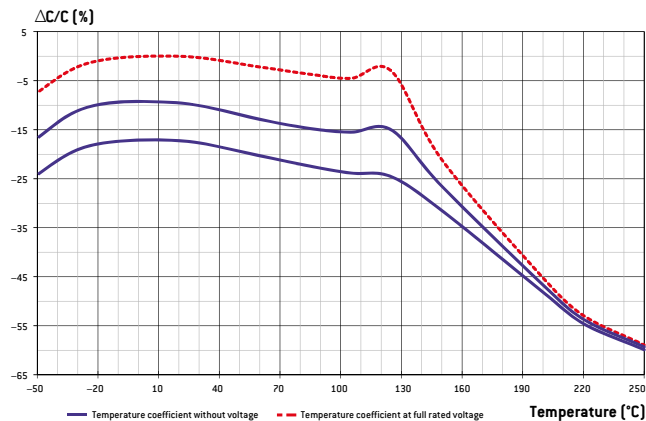

X7R: TYPICAL INSULATION RESISTANCE VERSUS TEMPERATURE

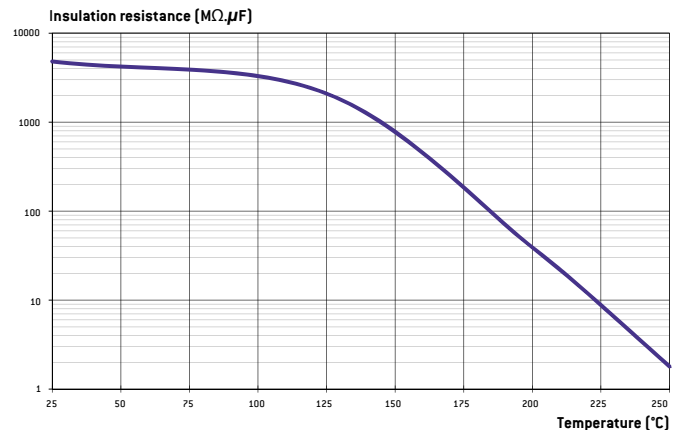

General Information

TYPICAL CURVES: SCT Series

$\Delta C/C$ VERSUS APPLIED VOLTAGE AND RATED VOLTAGE (U_R)

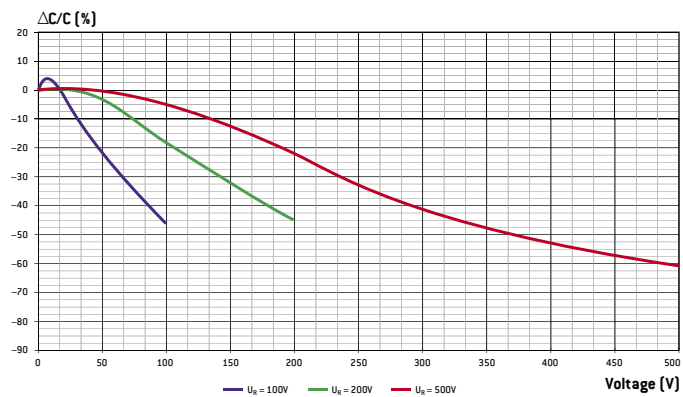

CAPACITANCE VERSUS TEMPERATURE

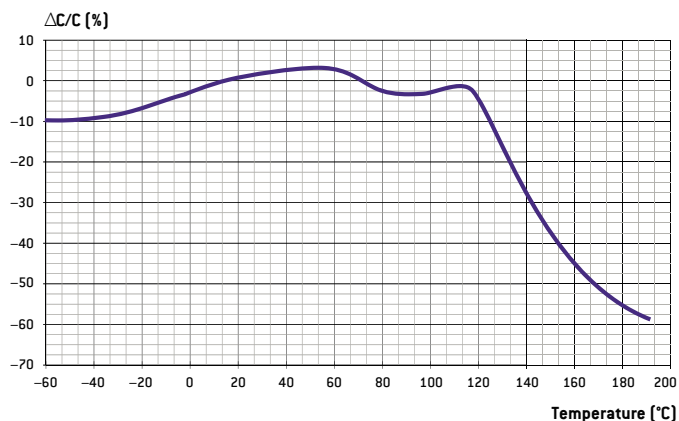

DIELECTRIC LOSSES VERSUS TEMPERATURE

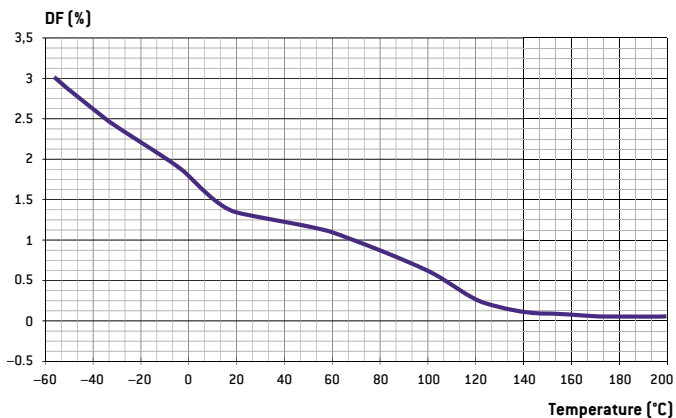

INSULATION RESISTANCE VERSUS TEMPERATURE

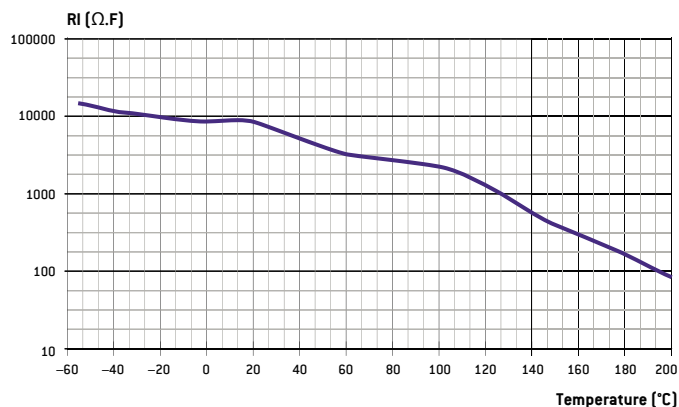

HIGH TEMPERATURE

CE/CN Series

High Temperature Chips Capacitors

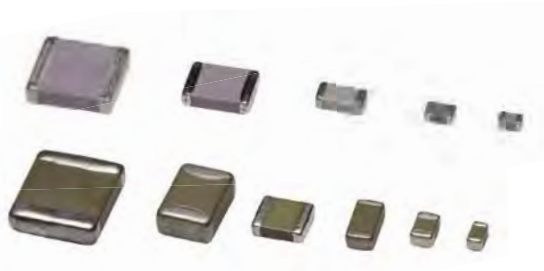

FEATURES

- Multilayer Chips Ceramic Capacitors for operating temperature up to 250°C
- Size 0603 to 3040
- NPO and X7R dielectrics
- Capacitance range: 1pF to 8.2μF
- Voltage range at 20°C: 16 V_{DC} to 100 V_{DC}

PHYSICAL CHARACTERISTICS

CONSTRUCTION

Bare chips capacitors for surface mounting with optional nickel barrier and tinning.

MARKING (clear or coded)

Capacitance value (not available on sizes 0603).

ELECTRICAL SPECIFICATIONS

Description	NPO	X7R
Operating temperature	-55°C to +250°C	-55°C to +250°C
Rated voltage at 20°C	16 V _{DC} to 100 V _{DC}	16 V _{DC} to 100 V _{DC}
Dielectric withstanding voltage at 20°C	2.5 U _{RC} for U _{RC} < 500 V _{DC} 1.5 U _{RC} for U _{RC} = 500 V _{DC}	2.5 U _{RC} for U _{RC} < 500 V _{DC} 1.5 U _{RC} for U _{RC} = 500 V _{DC}
Capacitance	at 1MHz for C ≤ 1,000pF at 1kHz for C > 1,000pF	at 1MHz for C ≤ 100pF at 1kHz for C > 100pF
Dissipation factor at 20°C	≤ 0.015 (150/C + 7)% at 1MHz for C ≤ 50pF ≤ 0.15% at 1MHz for 50pF < C ≤ 1,000pF ≤ 0.15% at 1kHz for C > 1,000pF	≤ 2.5% at 1MHz for C ≤ 100pF ≤ 2.5% at 1kHz for C > 100pF
Dissipation factor at 200°C	≤ 0.03 (150/C + 7)% at 1MHz for C ≤ 50pF ≤ 0.3% at 1MHz for 50pF < C ≤ 1,000pF ≤ 0.3% at 1kHz for C > 1,000pF	≤ 1.5% at 1MHz for C ≤ 100pF ≤ 1.5% at 1kHz for C > 100pF
Dissipation factor at 220°C	≤ 0.03 (150/C + 7)% at 1MHz for C ≤ 50pF ≤ 0.3% at 1MHz for 50pF < C ≤ 1,000pF ≤ 0.3% at 1kHz for C > 1,000pF	≤ 0.5% at 1MHz for C ≤ 100pF ≤ 0.5% at 1kHz for C > 100pF
Dissipation factor at 250°C	≤ 0.03 (150/C + 7)% at 1MHz for C ≤ 50pF ≤ 0.3% at 1MHz for 50pF < C ≤ 1,000pF ≤ 0.3% at 1kHz for C > 1,000pF	≤ 0.5% at 1MHz for C ≤ 100pF ≤ 0.5% at 1kHz for C > 100pF
Insulation resistance at 20°C under U _{RC}	≥ 100,000MΩ or ≥ 1,000MΩ.μF (whichever is less)	≥ 100,000MΩ or ≥ 1,000MΩ.μF (whichever is less)
Insulation resistance at 200°C under U _{RC}	≥ 1,000MΩ or ≥ 20MΩ.μF (whichever is less)	≥ 1,000MΩ or ≥ 10MΩ.μF (whichever is less)
Insulation resistance at 220°C under U _{RC}	≥ 800MΩ or ≥ 8MΩ.μF (whichever is less)	≥ 200MΩ or ≥ 4MΩ.μF (whichever is less)
Insulation resistance at 250°C under U _{RC}	≥ 200MΩ or ≥ 2MΩ.μF (whichever is less)	≥ 100MΩ or ≥ 1MΩ.μF (whichever is less)
Ageing	None	≤ 2.5% per decade hour

HOW TO ORDER

CNC	2	11						
CN	2X	0805	C	M	47nF	10%	100 V	S8
CN	5X	0805						
Series	Exxelia size code	Terminations	Marking	Capacitance	Tolerance	Rated voltage at 20°C	Packaging	
Operating temperature	14 = 0603 03 = 0805 08 = 1206 11 = 1210 20 = 1812 28 = 1825 30 = 2220 25 = 2225 33 = 3030 40 = 3040	W = RoHS compliant For working temperature up to 250°C For all sizes - Ag/Pd/Pt W Ag/Pd/Pt For working temperature up to 200°C Up to size 1210 for X7R and 2220 for NPO C Ag + Ni + electrolytic Sn/Pb 95/5 CW Ag + Ni + electrolytic Sn G Ag + Ni + Au GW Ag + Ni + Au D Ag + Ni* + electrolytic Sn/Pb 60/40 For working temperature up to 180°C Up to size 3030 YC Ag + Polymer + Ni + Sn/Pb 95/5 YCW Ag + Polymer + Ni + Sn YG Ag + Polymer + Ni + Au YGW Ag + Polymer + Ni + Au	- = no marking M = Marking: capacitance value clear or coded (not available on sizes 0603)	Capacitance value in clear	NPO: cap. value ≤ 12pF ±0.25pF cap. value ≤ 8.2pF ±0.5pF ±1pF cap. value > 22pF ±1% cap. value > 12pF ±2% cap. value > 8.2pF ±5% ±10% cap. value > 3.9pF ±20% X7R: ±10% ±20%	16V 25 V 50 V 100 V	- = Exxelia packaging S8 = available for 0402 to 1210 sizes. S12 = available for 1812 to 2220 sizes. BA = available for 0402 to 2220 sizes. See page 13	
Up to 200°C CEC2 = NPO CNC2 = X7R	For 2X and 5X series, use the standard size							
Up to 220°C CE2X = NPO CN2X = X7R								
Up to 250°C CE5X = NPO CN5X = X7R								

High Temperature Chips Capacitors

CE/CN Series

DIMENSIONS in inches (mm)

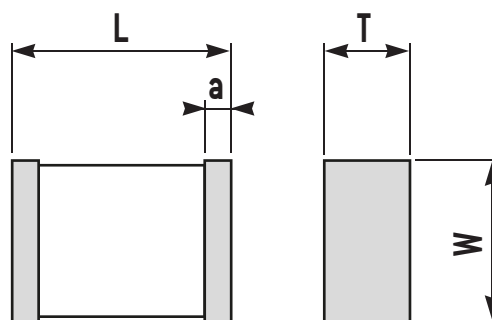

STANDARD RATINGS

Standard size		0603		0805		1206		1210		1812	
Excellia size code		14		03		08		11		20	
Dimensions inches (mm)	L	0.063 ± 0.006 (1.6 ± 0.15)		0.079 ± 0.012 (2 ± 0.3)		0.126 ± 0.01 (3.2 ± 0.25)		0.126 ± 0.016 (3.2 ± 0.4)		0.177 ± 0.02 (4.5 ± 0.5)	
	W	0.032 ± 0.006 (0.8 ± 0.15)		0.049 ± 0.008 (1.25 ± 0.2)		0.063 ± 0.006 (1.6 ± 0.15)		0.098 ± 0.012 (2.5 ± 0.3)		0.126 ± 0.016 (3.2 ± 0.4)	
	a	0.012 ± 0.008 (0.3 ± 0.2)		0.02 ± 0.012 (0.5 ± 0.3)		0.02 ± 0.012 (0.5 ± 0.3)		0.024 ± 0.016 (0.6 ± 0.4)		0.024 ± 0.016 (0.6 ± 0.4)	
	T max.	0.04 (1)		0.052 (1.3)		0.063 (1.6)		0.071 (1.8)		0.071 (1.8)	
Dielectric		NPO X7R		NPO X7R		NPO X7R		NPO X7R		NPO X7R	
Min. Capa. value		1pF 10pF		1pF 10pF		1pF 100pF		10pF 180pF		47pF 470pF	
Rated voltage (U _{RC})	20°C	200°C	220°C	250°C							
	16V 8V 5V 3V	2.7nF 120nF	12nF 470nF	22nF 1.2µF	56nF 2.2µF	100nF 4.7µF					
	25V 12V 8V 5V	1.8nF 56nF	6.8nF 220nF	15nF 680nF	39nF 1µF	47nF 2.2µF					
	50V 25V 16V 10V	820pF 33nF	3.3nF 120nF	8.2nF 270nF	18nF 560nF	27nF 1.2µF					
	100V 50V 25V 16V	330pF 12nF	1.5nF 39nF	3.9nF 120nF	8.2nF 220nF	15nF 470nF					

Standard size		1825		2220		2225		3030		3040	
Excellia size code		28		30		25		33		40	
Dimensions inches (mm)	L	0.177 ± 0.020 (4.5 ± 0.5)		0.224 ± 0.02 (5.7 ± 0.5)		0.224 ± 0.02 (5.7 ± 0.5)		0.299 ± 0.02 (7.6 ± 0.5)		0.299 ± 0.02 (7.6 ± 0.5)	
	W	0.250 ± 0.020 (6.35 ± 0.5)		0.197 ± 0.02 (5 ± 0.5)		0.250 ± 0.020 (6.35 ± 0.5)		0.299 ± 0.02 (7.6 ± 0.5)		0.4 ± 0.02 (10.16 ± 0.5)	
	a	0.024 ± 0.020 (0.6 ± 0.4)		0.024 ± 0.016 (0.6 ± 0.4)		0.024 ± 0.020 (0.6 ± 0.4)		0.024 ± 0.016 (0.6 ± 0.4)		0.024 ± 0.016 (0.6 ± 0.4)	
	T max.	0.071 (1.8)		0.071 (1.8)		0.079 (2)		0.079 (2)		0.079 (2)	
Dielectric		NPO X7R		NPO X7R		NPO X7R		NPO X7R		NPO X7R	
Min. Capa. value		100pF 1nF		100pF 1.2nF		150pF 1.5nF		390pF 4.7nF		680pF 8.2nF	
Rated voltage (U _{RC})	20°C	200°C	220°C	250°C							
	16V 8V 5V 3V	150nF 2.7µF	180nF 10µF	180nF 4.7µF	330nF 6.8µF	470nF 8.2µF					
	25V 12V 8V 5V	82nF 2.2µF	82nF 4.7µF	100nF 3.9µF	180nF 3.9µF	270nF 5.6µF					
	50V 25V 16V 10V	56nF 1.5µF	56nF 2.7µF	68nF 2.2µF	120nF 2.7µF	150nF 3.9µF					
	100V 50V 25V 16V	22nF 820nF	33nF 1µF	33nF 1.2µF	56nF 1.5µF	82nF 2.2µF					

Available capacitance values:

NPO: E6, E12, E24, E48, E96 (see page 14). Specific values upon request.

X7R: E6, E12, E24 (see page 14). Specific values upon request.

The above table defines the standard products, other components may be built upon request.

HIGH TEMPERATURE

SCT Series

High Temperature Stacked Capacitors



FEATURES

- Multilayer stacked ceramic capacitors
- Dielectric type II
- Capacitance range: 47nf to 390 μ F
- Voltage range: 50 V_{DC} to 500 V_{DC}

TERMINATIONS

- Ag 100% termination developed for high temperature up to 215°C. Less sensitive to thermal shocks and compatible with high melting point solder containing lead.
- DIL type J, L or N are available.

MARKING

Size	Marking codes	Example
	«TA» logo	TA
All sizes	Cap code + Tolerance code	105M
	Rated voltage value	100 V

ELECTRICAL SPECIFICATIONS

Description	«X» Series (type II)
CECC	2R1
EIA	X7R
Exxelia Temex Code	X
Operating temperature range	-55°C to +215°C
Maximum Δ C/°C over Temperature range without voltage applied	$\pm 15\%$
Ageing	$\leq 2.5\%$ per decade hour
Dissipation Factor (DF)	$\leq 2.5\%$
Voltage proof	U _R \leq 200 V: 2.5 x U _R U _R > 200 V: 2.0 x U _R
Insulation Resistance (IR) at 25°C under U _R	100G Ω or 1000 Ω .F whichever is the less
Insulation Resistance (IR) at 125°C under U _R	10G Ω or 100 Ω .F whichever is the less
Measurement Conditions for C and DF at 20°C	≤ 100 pF: 1MHz / 1Vrms (no bias) > 100pF: 1KHz / 1Vrms (no bias)
Capacitance versus applied Voltage and Temperature	See page 99

PACKAGING

«Blister» boxes:

For all products, special «blister» boxes are used to optimize the protection of the parts during the carriage and the storage. Depending upon the termination (with or without connection) and the size, the number of the parts in each box is defined. Please, consult us for more details.

HOW TO ORDER

201	SCT	01	X	105	K	R	-	-RoHS
Rated voltage	Series	Exxelia size code	Dielectric code	Capacitance	Tolerance	Termination	Coating	RoHS Compliant
500: 50 V 101: 100 V 201: 200 V 501: 500 V	SCT	00 01 02 04 05 06 07 10 12	X = X7R	1 st two digits represent significant figures; last digit specifies the number of zeros to follow. Examples: 104: 0.1 μ F 335: 3.3 μ F 156: 15 μ F 107: 10 μ F	K = $\pm 10\%$ M = $\pm 20\%$	DN DIL N type DJ DIL J type DL DIL L type	RoHS = HMP tinned phosphor bronze, non magnetic. - = uncoated and no marking U = uncoated and marked	Non-RoHS not available

High Temperature Stacked Capacitors

DIMENSIONS in inches (mm)

SC SERIES

Dual In Line DIL termination

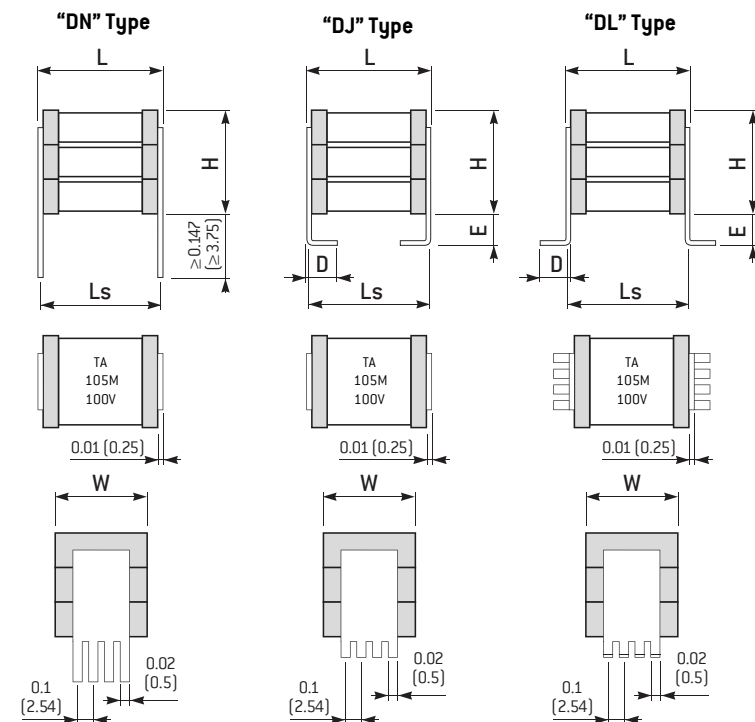

Size	L max.	W max.	LS ± 0.02* [±0.5]*	E ± 0.012 [±0.5]**	D ± 0.02 [±0.5]	Number of leads per side	H max.
SCT00	0.300 (7.62)	0.276 (7)	0.250 (6.35)	0.071 (1.8)	0.079 (2)	3	Please, consult the tables of standard ratings
SCT01	0.402 (10.2)	0.378 (9.6)	0.300 (7.62)	0.059 (1.5)	0.098 (2.5)	3	
SCT02	0.469 (11.9)	0.449 (11.4)	0.400 (10.16)	0.059 (1.5)	0.098 (2.5)	4	
SCT04	0.650 (16.5)	0.552 (14)	0.539 (13.7)	0.059 (1.5)	0.098 (2.5)	5	
SCT05	0.729 (18.5)	0.670 (17)	0.700 (17.78)	0.059 (1.5)	0.098 (2.5)	6	
SCT06	0.701 (17.8)	0.851 (21.6)	0.600 (15.24)	0.059 (1.5)	0.098 (2.5)	7	
SCT07	0.894 (22.7)	0.654 (16.6)	0.800 (20.32)	0.059 (1.5)	0.098 (2.5)	6	
SCT10	0.520 (13.2)	1.083 (27.5)	0.453 (11.5)	0.083 (2.1)	0.102 (2.6)	10	
SCT12	0.945 (24)	1.598 (40.6)	0.800 (20.32)	0.098 (2.5)	0.098 (2.5)	14	

* Except for the SCT07, tolerance = ± 0.032 in (±0.8mm).

** For the SCT12, tolerance = ± 0.012 in (±0.3mm).

Note: the marking shown here is just given as an example

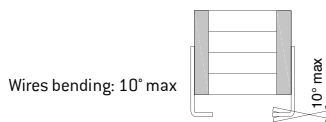

DERATING RULES

The given voltages in the below capacitance range are the nominal voltages at 125°C.

For higher operating temperatures, the derating rules to be applied on the voltage versus temperature are defined as per the following table :

125°C	200°C	215°C
500V	200V	100V
200V	100V	50V
100V	50V	25V
50V	25V	16V

SCT Series

High Temperature Stacked Capacitors

STANDARD RATINGS

Exxelia size code	2225				3033				3740				5550				Cap. code	
	SCT00				SCT01				SCT02				SCT04					
	U _R	50 V	100 V	200 V	500 V	50 V	100 V	200 V	500 V	50 V	100 V	200 V	500 V	50 V	100 V	200 V		500 V
47nf				0.118 (3)				0.083 (2.1)										473
56				0.118 (3)				0.083 (2.1)										563
68				0.118 (3)				0.083 (2.1)										683
82				0.118 (3)				0.083 (2.1)										823
100			0.039 (1.8)	0.118 (3)			0.083 (2.1)	0.098 (2.5)				0.118 (3)						104
120			0.039 (1.8)	0.118 (3)			0.083 (2.1)	0.098 (2.5)				0.118 (3)						124
150			0.079 (2)	0.252 (6.4)			0.083 (2.1)	0.098 (2.5)				0.118 (3)						154
180	0.039 (1.8)	0.039 (1.8)	0.079 (2)	0.252 (6.4)	0.083 (2.1)	0.083 (2.1)	0.083 (2.1)	0.126 (3.2)			0.083 (2.1)	0.118 (3)						184
220	0.039 (1.8)	0.039 (1.8)	0.098 (2.5)	0.252 (6.4)	0.083 (2.1)	0.083 (2.1)	0.083 (2.1)	0.126 (3.2)			0.083 (2.1)	0.118 (3)						224
270	0.039 (1.8)	0.039 (1.8)	0.098 (2.5)	0.378 (9.6)	0.083 (2.1)	0.083 (2.1)	0.083 (2.1)	0.138 (3.5)			0.083 (2.1)	0.118 (3)				0.098 (2.5)		274
330	0.039 (1.8)	0.039 (1.8)	0.118 (3)	0.378 (9.6)	0.083 (2.1)	0.083 (2.1)	0.083 (2.1)	0.241 (6.1)	0.083 (2.1)	0.083 (2.1)	0.083 (2.1)	0.130 (3.3)				0.098 (2.5)		334
390	0.039 (1.8)	0.039 (1.8)	0.118 (3)	0.504 (12.8)	0.083 (2.1)	0.083 (2.1)	0.083 (2.1)	0.241 (6.1)	0.083 (2.1)	0.083 (2.1)	0.083 (2.1)	0.138 (3.5)				0.098 (2.5)		394
470	0.039 (1.8)	0.039 (1.8)	0.213 (5.4)	0.504 (12.8)	0.083 (2.1)	0.083 (2.1)	0.083 (2.1)	0.272 (6.9)	0.083 (2.1)	0.083 (2.1)	0.083 (2.1)	0.157 (4)				0.118 (3)		474
560	0.079 (2)	0.079 (2)	0.232 (5.9)	0.551 (14)	0.083 (2.1)	0.083 (2.1)	0.098 (2.5)	0.414 (10.5)	0.083 (2.1)	0.083 (2.1)	0.083 (2.1)	0.169 (4.3)				0.118 (3)		564
680	0.079 (2)	0.079 (2)	0.252 (6.4)	0.630 (16)	0.083 (2.1)	0.083 (2.1)	0.118 (3)	0.414 (10.5)	0.083 (2.1)	0.083 (2.1)	0.098 (2.5)	0.276 (7)				0.118 (3)		684
820	0.079 (2)	0.079 (2)	0.319 (8.1)	0.709 (18)	0.083 (2.1)	0.083 (2.1)	0.138 (3.5)	0.548 (13.9)	0.083 (2.1)	0.083 (2.1)	0.098 (2.5)	0.390 (9.9)			0.118 (3)	0.138 (3.5)		824
1 μF	0.087 (2.2)	0.087 (2.2)	0.378 (9.6)		0.098 (2.5)	0.098 (2.5)	0.174 (4.4)	0.583 (14.8)	0.083 (2.1)	0.083 (2.1)	0.118 (3)	0.406 (10.3)			0.118 (3)	0.165 (4.2)		105
1.2	0.098 (2.5)	0.098 (2.5)	0.504 (12.8)		0.098 (2.5)	0.098 (2.5)	0.213 (5.4)	0.669 (17.6)	0.083 (2.1)	0.083 (2.1)	0.138 (3.5)	0.552 (14)			0.118 (3)	0.252 (6.4)		125
1.5	0.118 (3)	0.118 (3)	0.551 (14)		0.110 (2.8)	0.110 (2.8)	0.260 (6.6)		0.083 (2.1)	0.083 (2.1)	0.157 (4)	0.630 (16)			0.118 (3)	0.378 (9.6)		155
1.8	0.173 (4.4)	0.173 (4.4)	0.630 (16.4)		0.110 (2.8)	0.110 (2.8)	0.347 (8.8)		0.098 (2.5)	0.098 (2.5)	0.233 (5.9)	0.709 (18)	0.098 (2.5)	0.098 (2.5)	0.118 (3)	0.378 (9.6)		185
2.2	0.197 (5.1)	0.197 (5.1)	0.630 (16.4)		0.110 (2.8)	0.110 (2.8)	0.426 (10.8)		0.098 (2.5)	0.098 (2.5)	0.252 (6.4)	0.709 (18)	0.098 (2.5)	0.098 (2.5)	0.118 (3)	0.378 (9.6)		225
2.7	0.232 (5.9)	0.232 (5.9)			0.130 (3.3)	0.130 (3.3)	0.552 (14)		0.110 (2.8)	0.110 (2.8)	0.252 (6.4)		0.098 (2.5)	0.098 (2.5)	0.138 (3.5)	0.504 (12.8)		275
3.3	0.296 (7.5)	0.296 (7.5)			0.150 (3.8)	0.150 (3.8)	0.591 (15)		0.110 (2.8)	0.110 (2.8)	0.378 (9.6)		0.098 (2.5)	0.098 (2.5)	0.157 (4)	0.583 (14.8)		335
3.9	0.339 (8.6)	0.339 (8.6)			0.237 (6)	0.244 (6.2)			0.130 (3.3)	0.130 (3.3)	0.378 (9.6)		0.098 (2.5)	0.098 (2.5)	0.252 (6.4)	0.662 (16.8)		395
4.7	0.378 (9.6)	0.378 (9.6)			0.237 (6)	0.252 (6.4)			0.138 (3.5)	0.138 (3.5)	0.504 (12.8)		0.118 (3)	0.118 (3)	0.378 (9.6)			475
5.6	0.484 (12.3)	0.484 (12.3)			0.276 (7)	0.283 (7.2)			0.142 (3.6)	0.142 (3.6)	0.630 (16)		0.118 (3)	0.118 (3)	0.378 (9.6)			565
6.8	0.504 (12.8)	0.504 (12.8)			0.315 (8)	0.323 (8.2)			0.185 (4.7)	0.185 (4.7)	0.709 (18)		0.118 (3)	0.118 (3)	0.434 (11)			685
8.2	0.630 (16)	0.630 (16)			0.434 (11)	0.441 (11.2)			0.284 (7.2)	0.354 (9)			0.138 (3.5)	0.138 (3.5)	0.438 (11.1)			825
10					0.473 (12)	0.480 (12.2)			0.292 (7.4)	0.354 (9)			0.150 (3.8)	0.150 (3.8)	0.497 (12.6)			106
12					0.552 (14)	0.559 (14.4)			0.414 (10.5)	0.472 (12)			0.252 (6.4)	0.252 (6.4)	0.630 (16)			126
15									0.438 (11.1)	0.492 (12.5)			0.284 (7.2)	0.319 (8.1)				156
18									0.583 (14.8)	0.591 (15)			0.304 (7.7)	0.394 (10.8)				186
22									0.598 (15.2)	0.598 (15.2)			0.315 (8)	0.504 (12.8)				226
27													0.461 (11.7)	0.504 (12.8)				276
33													0.473 (12)	0.583 (14.8)				336
39													0.630 (16)	0.662 (16.8)				396

* Consult us - The height Hmax in inches (in mm) for the SCT Series is indicated in the cells.

High Temperature Stacked Capacitors

SCT Series

STANDARD RATINGS

Exxelia size code	6560				6080 / 8060				45107				45214				Cap. code
	SCT05				SCT06 / SCT07				SCT10				SCT11				
	U _R	50 V	100 V	200 V	500 V	50 V	100 V	200 V	500 V	50 V	100 V	200 V	500 V	50 V	100 V	200 V	
270nf				0.098 (2.5)													274
330				0.098 (2.5)													334
390				0.098 (2.5)													394
470				0.098 (2.5)				0.118 (3)									474
560			0.098 (2.5)	0.098 (2.5)				0.118 (3)									564
680			0.098 (2.5)	0.098 (2.5)				0.118 (3)				0.138 (3.5)					684
820			0.098 (2.5)	0.118 (3)				0.118 (3)			0.118 (3)	0.138 (3.5)					824
1 μF	0.098 (2.5)	0.098 (2.5)	0.098 (2.5)	0.118 (3)				0.118 (3)	0.118 (3)	0.118 (3)	0.150 (3.8)						105
1.2	0.098 (2.5)	0.098 (2.5)	0.098 (2.5)	0.138 (3.5)				0.138 (3.5)	0.118 (3)	0.118 (3)	0.118 (3)	0.150 (3.8)					125
1.5	0.098 (2.5)	0.098 (2.5)	0.098 (2.5)	0.157 (4)			0.118 (3)	0.157 (4)	0.118 (3)	0.118 (3)	0.118 (3)	0.252 (6.4)					155
1.8	0.098 (2.5)	0.098 (2.5)	0.098 (2.5)	0.177 (4.5)			0.118 (3)	0.177 (4.5)	0.118 (3)	0.118 (3)	0.118 (3)	0.252 (6.4)					185
2.2	0.098 (2.5)	0.098 (2.5)	0.098 (2.5)	0.272 (6.9)			0.118 (3)	0.272 (6.9)	0.118 (3)	0.118 (3)	0.138 (3.5)	0.252 (6.4)					225
2.7	0.098 (2.5)	0.098 (2.5)	0.118 (3)	0.312 (7.9)			0.118 (3)	0.378 (9.6)	0.118 (3)	0.118 (3)	0.150 (3.8)	0.292 (7.4)				*	275
3.3	0.098 (2.5)	0.098 (2.5)	0.118 (3)	0.331 (8.4)			0.118 (3)	0.398 (10.1)	0.118 (3)	0.118 (3)	0.157 (4)	0.378 (9.6)				*	335
3.9	0.098 (2.5)	0.098 (2.5)	0.138 (3.5)	0.438 (11.1)	0.118 (3)	0.118 (3)	0.138 (3.5)	0.504 (12.8)	0.118 (3)	0.118 (3)	0.213 (5.4)	0.504 (12.8)				*	395
4.7	0.098 (2.5)	0.098 (2.5)	0.157 (4)	0.497 (12.6)	0.118 (3)	0.118 (3)	0.157 (4)	0.583 (14.8)	0.118 (3)	0.118 (3)	0.233 (5.9)	0.583 (14.8)				*	475
5.6	0.098 (2.5)	0.098 (2.5)	0.233 (5.9)	0.662 (16.8)	0.118 (3)	0.118 (3)	0.252 (6.4)	0.583 (14.8)	0.118 (3)	0.118 (3)	0.252 (6.4)	0.583 (14.8)				*	565
6.8	0.098 (2.5)	0.098 (2.5)	0.252 (6.4)	0.819 (20.8)	0.118 (3)	0.118 (3)	0.252 (6.4)	0.661 (16.8)	0.118 (3)	0.118 (3)	0.319 (8.1)	0.662 (16.8)				*	685
8.2	0.118 (3)	0.118 (3)	0.359 (9.1)		0.118 (3)	0.118 (3)	0.378 (9.6)	0.740 (18.8)	0.118 (3)	0.118 (3)	0.378 (9.6)				*	*	825
10	0.118 (3)	0.118 (3)	0.378 (9.6)		0.138 (3.5)	0.138 (3.5)	0.378 (9.6)		0.138 (3.5)	0.138 (3.5)	0.378 (9.6)				*	*	106
12	0.138 (3.5)	0.138 (3.5)	0.504 (12.8)		0.138 (3.5)	0.138 (3.5)	0.504 (12.8)		0.138 (3.5)	0.138 (3.5)	0.504 (12.8)			*	*	*	126
15	0.157 (4)	0.157 (4)	0.583 (14.8)		0.138 (3.5)	0.138 (3.5)	0.504 (12.8)		0.252 (6.4)	0.252 (6.4)	0.504 (12.8)			*	*		156
18	0.252 (6.4)	0.252 (6.4)			0.146 (3.7)	0.146 (3.7)	0.630 (16)		0.252 (6.4)	0.252 (6.4)	0.661 (16.8)			*	*		186
22	0.252 (6.4)	0.252 (6.4)			0.252 (6.4)	0.291 (7.4)	0.740 (18.8)		0.378 (9.6)	0.378 (9.6)				*	*		226
27	0.312 (7.9)	0.378 (9.6)			0.252 (6.4)	0.323 (8.2)	0.740 (18.8)		0.378 (9.6)	0.378 (9.6)				*	*	*	276
33	0.331 (8.4)	0.378 (9.6)			0.280 (7.1)	0.413 (10.5)			0.504 (12.8)	0.504 (12.8)				*	*	*	336
39	0.457 (11.6)	0.504 (12.8)			0.378 (9.6)	0.441 (11.2)			0.504 (12.8)	0.504 (12.8)				*	*		396
47	0.497 (12.6)	0.504 (12.8)			0.378 (9.6)	0.465 (11.8)			0.591 (15)	0.591 (15)				*	*		476
56	0.662 (16.8)	0.669 (17)			0.457 (11.6)	0.472 (12)			0.591 (15)	0.591 (15)				*	*		566
68					0.583 (14.8)	0.591 (15)								*	*		686
82														*			826
100														*			107
120														*			127

* Consult us - The height Hmax in inches (in mm) for the SCT Series is indicated in the cells.

SCT Series

High Temperature Stacked Capacitors

STANDARD RATINGS

Exxelia size code	80150				125205				Cap. code
	SCT12				SCT18				
	50 V	100 V	200 V	500 V	50 V	100 V	200 V	500 V	
680nf									684
820									824
1 µF									105
1.2									125
1.5									155
1.8									185
2.2									225
2.7				0.157 (4)					275
3.3				0.157 (4)					335
3.9				0.157 (4)					395
4.7				0.157 (4)					475
5.6				0.315 (8)					565
6.8				0.315 (8)					685
8.2			0.157 (4)	0.315 (8)			*		825
10			0.157 (4)	0.315 (8)			*		106
12			0.315 (8)	0.472 (12)			*		126
15			0.315 (8)	0.472 (12)			*		156
18		*	0.315 (8)	0.630 (16)			*		186
22		*	0.315 (8)	*			*	*	226
27		*	0.472 (12)	*			*	*	276
33		0.157 (4)	0.472 (12)	*			*	*	336
39	0.157 (4)	0.157 (4)	0.630 (16)			*	*	*	396
47	0.157 (4)	0.315 (8)	*			*	*	*	476
56	0.315 (8)	0.315 (8)	*			*	*	*	566
68	0.315 (8)	0.315 (8)				*	*		686
82	0.315 (8)	0.315 (8)			*	*	*		826
100	0.315 (8)	0.472 (12)			*	*	*		107
120	0.472 (12)	0.472 (12)			*	*			127
150	0.472 (12)	0.630 (16)			*	*			157
180	0.630 (16)				*	*			187
220					*	*			227
270					*				277
330					*				337
390					*				397

* Consult us - The height Hmax in inches (in mm) for the SCT Series is indicated in the cells.

High Temperature Molded Capacitors

TCE / TCN Molded Series HT

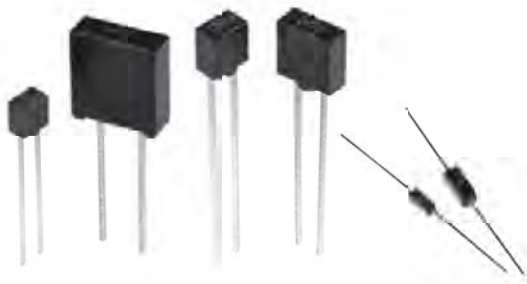

FEATURES

- Multilayer chips ceramic capacitors for operating temperature up to 220°C
- NPO and X7R dielectrics
- Capacitance range: 1pF to 10µF
- Voltage range at 20°C: 16 V_{DC} to 100 V_{DC}

PHYSICAL CHARACTERISTICS

CONSTRUCTION

Epoxy molded radial or axial leaded chips capacitors for through-hole circuits.

MARKING (clear or coded)

Series, capacitance value, tolerance, voltage, date code.

ELECTRICAL SPECIFICATIONS

Description	NPO	X7R
Operating temperature	-55°C to +220°C	-55°C to +220°C
Rated voltage at 20°C	16 V _{DC} to 100 V _{DC}	16 V _{DC} to 100 V _{DC}
Dielectric withstanding voltage at 20°C	2.5 U _{RC} for U _{RC} < 500 V _{DC}	2.5 U _{RC} for U _{RC} < 500 V _{DC}
	1.5 U _{RC} for U _{RC} = 500 V _{DC}	1.5 U _{RC} for U _{RC} = 500 V _{DC}
Capacitance	at 1MHz for C ≤ 1,000pF	at 1MHz for C ≤ 100pF
	at 1kHz for C > 1,000pF	at 1kHz for C > 100pF
Dissipation factor at 20°C	≤ 0.015 (150/C + ?)% at 1MHz for C ≤ 50pF	≤ 2.5% at 1MHz for C ≤ 100pF
	≤ 0.15% at 1MHz for 50pF < C ≤ 1,000pF	≤ 2.5% at 1kHz for C > 100pF
	≤ 0.15% at 1kHz for C > 1,000pF	
Dissipation factor at 200°C	≤ 0.03 (150/C + ?)% at 1MHz for C ≤ 50pF	≤ 1.5% at 1MHz for C ≤ 100pF
	≤ 0.3% at 1MHz for 50pF < C ≤ 1,000pF	≤ 1.5% at 1kHz for C > 100pF
	≤ 0.3% at 1kHz for C > 1,000pF	
Dissipation factor at 220°C	≤ 0.03 (150/C + ?)% at 1MHz for C ≤ 50pF	≤ 0.5% at 1MHz for C ≤ 100pF
	≤ 0.3% at 1MHz for 50pF < C ≤ 1,000pF	≤ 0.5% at 1kHz for C > 100pF
	≤ 0.3% at 1kHz for C > 1,000pF	
Insulation resistance at 20°C under U _{RC}	≥ 50,000MΩ or ≥ 1,000MΩ.µF (whichever is less)	≥ 20,000MΩ or ≥ 500MΩ.µF (whichever is less)
Insulation resistance at 200°C under U _{RC}	≥ 1,000MΩ or ≥ 20MΩ.µF (whichever is less)	≥ 200MΩ or ≥ 5MΩ.µF (whichever is less)
Insulation resistance at 220°C under U _{RC}	≥ 200MΩ or ≥ 5MΩ.µF (whichever is less)	≥ 100MΩ or ≥ 2MΩ.µF (whichever is less)
Ageing	None	≤ 2.5% per decade hour

HOW TO ORDER

Series	Exxelia size code	Terminations	RoHS compliant	Capacitance	Tolerance	Rated voltage at 20°C
TCE 2	01	-	W	12nF	10%	16 V
TCE 2X	01	-	W	12nF	10%	16 V
Operating temperature	01 02 03 04 51 52 53 54 55 56	- = Tinned copper leads Available on sizes 01, 02, 03, 04: D = Tinned nickel leads	- = No RoHS W = RoHS compliant	Capacitance value in clear	NPO: cap. value ≤ 12pF ±0.25pF cap. value ≤ 8.2pF ±0.5pF cap. value > 22pF ±1pF cap. value > 12pF ±1% cap. value > 12pF ±2% cap. value > 8.2pF ±5% cap. value > 3.9pF ±10% X7R: ±10% ±20%	16V 25V 50V 100V

TCE / TCN Molded Series HT

High Temperature Molded Capacitors

DIMENSIONS in inches (mm)

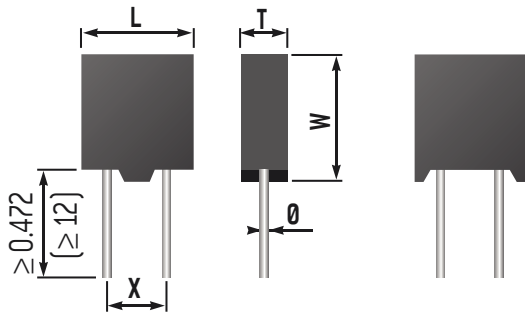

TCE/TCN 201, 202, 203, 204

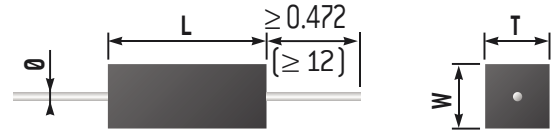

TCE/TCN 251, 252, 253, 254

STANDARD RATINGS

Exxelia size code		01		02		03		04		52		53		54			
Dimensions inches (mm)	L ± 0.02 (± 0.5)	0.122 (3.1)	0.197 (5)	0.295 (7.5)	0.394 (10)	0.217 (5.5)	0.295 (7.5)	0.394 (10)	0.099 (2.5)	0.099 (2.5)	0.154 (3.9)	0.099 (2.5)	0.099 (2.5)	0.154 (3.9)	0.154 (3.9)		
	W max.	0.178 (4.5)	0.237 (6)	0.335 (8.5)	0.434 (11)	0.099 (2.5)	0.099 (2.5)	0.154 (3.9)	0.099 (2.5)	0.099 (2.5)	0.154 (3.9)	0.099 (2.5)	0.099 (2.5)	0.154 (3.9)	0.154 (3.9)		
	T ± 0.008 (± 0.2)	0.098 (2.5)	0.098 (2.5)	0.098 (2.5)	0.138 (3.5)	0.098 (2.5)	0.098 (2.5)	0.138 (3.5)	0.098 (2.5)	0.098 (2.5)	0.138 (3.5)	0.098 (2.5)	0.098 (2.5)	0.138 (3.5)	0.138 (3.5)		
	X ± 0.008 (± 0.2)	0.1 (2.54)	0.1 (2.54)	0.2 (5.08)	0.2 (5.08)	-	-	-	-	-	-	-	-	-	-		
	Ø ± 10%	0.024 (0.6)	0.024 (0.6)	0.024 (0.6)	0.031 (0.8)	0.024 (0.6)	0.024 (0.6)	0.031 (0.8)	0.024 (0.6)	0.024 (0.6)	0.024 (0.6)	0.024 (0.6)	0.024 (0.6)	0.024 (0.6)	0.024 (0.6)		
Dielectric		NPO	X7R	NPO	X7R	NPO	X7R	NPO	X7R	NPO	X7R	NPO	X7R	NPO	X7R		
Min. capacitance value		1pF	10pF	10pF	180pF	100pF	1.2nF	390pF	4.7nF	1pF	10pF	1pF	100pF	10pF	180pF		
Rated voltage (U _{rated})	20°C	200°C	220°C														
	16V	8V	5V	12nF	470nF	56nF	2.2µF	180nF	10µF	330nF	10µF	12nF	470nF	22nF	1.2µF	56nF	2.2µF
	25V	12V	8V	6.8nF	220nF	39nF	1µF	82nF	4.7µF	180nF	4.7µF	6.8nF	220nF	15nF	680nF	39nF	1µF
	50V	25V	16V	3.3nF	120nF	18nF	560nF	56nF	2.7µF	120nF	2.7µF	3.3nF	120nF	8.2nF	270nF	18nF	560nF
100V	50V	25V	1.5nF	39nF	8.2nF	220nF	33nF	1µF	56nF	1.5µF	1.5nF	39nF	3.9nF	120nF	8.2nF	220nF	

Available capacitance values:

NPO: E6, E12, E24 (see page 14). Specific values upon request.

X7R: E6, E12 (see page 14). Specific values upon request.

The above table defines the standard products, other components may be built upon request.

High Temperature Self-Protected Capacitors

TCE / TCN Self-Protected Series

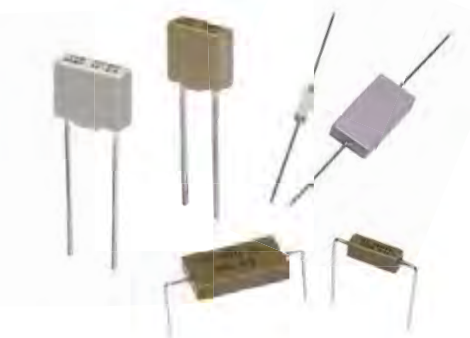

FEATURES

- Multilayer Chips Ceramic Capacitors for operating temperature up to 250°C
- NPO and X7R dielectrics
- Capacitance range: 10pF to 3.3µF
- Voltage range at 20°C: 25 V_{DC} to 500 V_{DC}

PHYSICAL CHARACTERISTICS

CONSTRUCTION

Selfprotected radial or axial leaded chips capacitors for through-hole circuits. Mechanical stress is eliminated by replacement of epoxy by selfprotected ceramic.

MARKING (clear or coded)

Series, capacitance value, tolerance, voltage, date code.

ELECTRICAL SPECIFICATIONS

Description	NPO	X7R
Operating temperature	-55°C to +250°C	-55°C to +250°C
Rated voltage at 20°C	25 V _{DC} to 500 V _{DC}	25 V _{DC} to 500 V _{DC}
Dielectric withstanding voltage at 20°C	2.5 U _{RC}	2.5 U _{RC}
Capacitance	at 1MHz for C ≤ 1,000pF at 1kHz for C > 1,000pF	at 1MHz for C ≤ 100pF at 1kHz for C > 100pF
Dissipation factor at 20°C	≤ 0.015 (150/C + 7)% at 1MHz for C ≤ 50pF ≤ 0.15% at 1MHz for 50pF < C ≤ 1,000pF ≤ 0.15% at 1kHz for C > 1,000pF	≤ 2.5% at 1MHz for C ≤ 100pF ≤ 2.5% at 1kHz for C > 100pF
Dissipation factor at 200°C	≤ 0.03 (150/C + 7)% at 1MHz for C ≤ 50pF ≤ 0.3% at 1MHz for 50pF < C ≤ 1,000pF ≤ 0.3% at 1kHz for C > 1,000pF	≤ 1.5% at 1MHz for C ≤ 100pF ≤ 1.5% at 1kHz for C > 100pF
Dissipation factor at 220°C	≤ 0.03 (150/C + 7)% at 1MHz for C ≤ 50pF ≤ 0.3% at 1MHz for 50pF < C ≤ 1,000pF ≤ 0.3% at 1kHz for C > 1,000pF	≤ 0.5% at 1MHz for C ≤ 100pF ≤ 0.5% at 1kHz for C > 100pF
Dissipation factor at 250°C	≤ 0.03 (150/C + 7)% at 1MHz for C ≤ 50pF ≤ 0.3% at 1MHz for 50pF < C ≤ 1,000pF ≤ 0.3% at 1kHz for C > 1,000pF	≤ 0.5% at 1MHz for C ≤ 100pF ≤ 0.5% at 1kHz for C > 100pF
Insulation resistance at 20°C under U _{RC}	≥ 100,000MΩ or ≥ 1,000MΩ.µF (whichever is less)	≥ 100,000MΩ or ≥ 1,000MΩ.µF (whichever is less)
Insulation resistance at 200°C under U _{RC}	≥ 1,000MΩ or ≥ 20MΩ.µF (whichever is less)	≥ 1,000MΩ or ≥ 10MΩ.µF (whichever is less)
Insulation resistance at 220°C under U _{RC}	≥ 800MΩ or ≥ 8MΩ.µF (whichever is less)	≥ 200MΩ or ≥ 4MΩ.µF (whichever is less)
Insulation resistance at 250°C under U _{RC}	≥ 200MΩ or ≥ 5MΩ.µF (whichever is less)	≥ 100MΩ or ≥ 2MΩ.µF (whichever is less)
Ageing	None	≤ 2.5% per decade hour

HOW TO ORDER

Series	Exxelia size code	Leads spacing code	RoHS compliant	Capacitance	Tolerance	Rated voltage at 20°C
TCN2	64	2	W	180pF	10%	100 V
TCN2X	64					
TCN5X	64					
Operating temperature Up to 200°C TCE2 = NPO TCN2 = X7R Up to 220°C TCE2X = NPO TCN2X = X7R Up to 250°C TCE5X = NPO TCN5X = X7R	12 13 14 15 16 63 64 65 66	Available on sizes 63, 64, 65, 66: - 2 3	- = No RoHS Available on sizes 63, 64, 65, 66: W = RoHS compliant Lead free version available for operating temperature up to 175°C (contact your sales representative)	Capacitance value in clear	NPO: cap. value ≤ 12pF ±10% ±0.25pF cap. value ≤ 8.2pF ±0.5pF ±1pF cap. value > 22pF ±1% cap. value > 12pF ±2% cap. value > 8.2pF ±5% ±10% cap. value > 3.9pF ±20%	25 V 50 V 100 V 500 V

TCE / TCN Self-Protected Series

High Temperature Self-Protected Capacitors

DIMENSIONS in inches (mm)

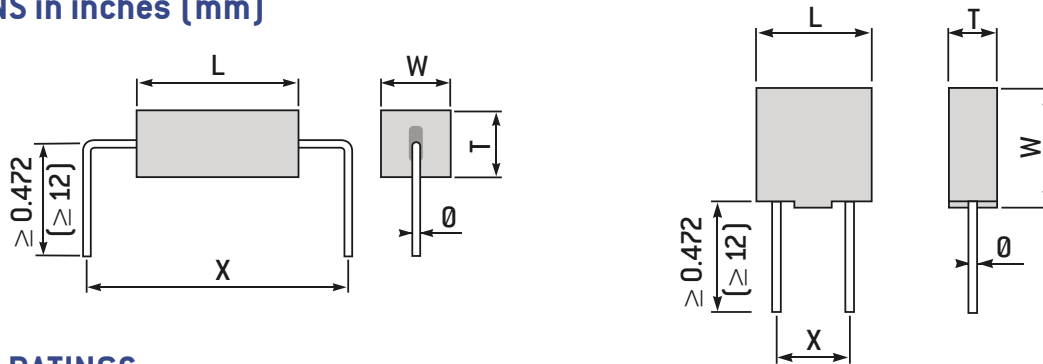

STANDARD RATINGS

Exxelia size code		12		13		14		15		16		63				
Leads spacing code		-		-		-		-		-		2				
Dimensions inches (mm)	L	0.284 ± 0.012 (7.2 ± 0.3)		0.315 ± 0.012 (8 ± 0.3)		0.315 ± 0.012 (8 ± 0.3)		0.559 ± 0.012 (14.2 ± 0.3)		0.559 ± 0.012 (14.2 ± 0.3)		0.267 max (6.85 max)				
	W	0.244 ± 0.012 (6.2 ± 0.3)		0.315 ± 0.012 (8 ± 0.3)		0.315 ± 0.012 (8 ± 0.3)		0.417 ± 0.012 (10.6 ± 0.3)		0.417 ± 0.012 (10.6 ± 0.3)		0.1 max (2.54 max)				
	T max.	0.099 (2.5)		0.099 (2.5)		0.15 (3.8)		0.099 (2.5)		0.15 (3.8)		0.1 (2.54)				
	X	0.2 ± 0.008 (5.08 ± 0.2)		0.2 ± 0.008 (5.08 ± 0.2)		0.2 ± 0.008 (5.08 ± 0.2)		0.4 ± 0.008 (10.16 ± 0.2)		0.4 ± 0.008 (10.16 ± 0.2)		0.5 ± 0.02 (12.7 ± 0.5) 0.6 ± 0.02 (15.24 ± 0.5)				
	Ø ± 10%	0.024 (0.6)		0.024 (0.6)		0.031 (0.8)		0.039 (1)		0.039 (1)		0.024 (0.6)				
Dielectric		NPO		X7R		NPO		X7R		NPO		X7R				
Min. Capacitance value		10pF		3.3nF		270pF		15nF		680pF		22nF				
Rated voltage (U _{DC})	20°C	200°C	220°C	250°C												
	25V	12V	8V	5V	-	-	-	-	-	-	-	-	8.2nF	180nF		
	50V	25V	16V	10V	6.8nF	390nF	12nF	680nF	22nF	1.2µF	33nF	1.8µF	56nF	3.9µF	4.7nF	120nF
	100V	50V	25V	16V	3.9nF	180nF	6.8nF	330nF	15nF	680nF	22nF	1µF	39nF	1.8µF	3.3nF	47nF
	500V	250V	125V	63V	-	-	-	-	-	-	-	-	-	-	330pF	-

Exxelia size code		64			65			66					
Leads spacing code		-			2			3					
Dimensions inches (mm)	L	0.4 max (10.16 max)			0.517 (13.2 max)			0.717 (18.2 max)					
	W	0.15 max (3.8 max)			0.264 max (6.7 max)			0.37 max (9.4 max)					
	T max.	0.15 (3.8)			0.158 (4)			0.158 (4)					
	X	0.6 ± 0.02 (15.24 ± 0.5)		0.7 ± 0.02 (17.78 ± 0.5)		1 ± 0.02 (25.4 ± 0.5)		0.7 ± 0.02 (17.78 ± 0.5)		0.9 ± 0.02 (22.86 ± 0.5) 0.95 ± 0.02 (24.13 ± 0.5) 1 ± 0.02 (25.4 ± 0.5)			
	Ø ± 10%	0.024 (0.6)			0.024 (0.6)			0.024 (0.6)					
Dielectric		NPO			X7R			NPO			X7R		
Min. Capacitance value		100pF			180pF			390pF			390pF		
Rated voltage (U _{DC})	20°C	200°C	220°C	250°C									
	25V	12V	8V	5V	27nF	560nF	68nF	1.8µF	150nF	3.3µF			
	50V	25V	16V	10V	15nF	330nF	39nF	1µF	100nF	1.8µF			
	100V	50V	25V	16V	10nF	120nF	22nF	330nF	56nF	820nF			

Available capacitance values:

NPO: E6, E12, E24 (see page 14). Specific values upon request.

X7R: E6, E12 (see page 14). Specific values upon request.

Exxelia can deliver axial leads on size code 263, 264, 265, 266 to allow the customer to obtain the leads spacing needed (leads spacing code = 9). In that case we recommend to bend the connections at a distance from the ceramic body of 5mm minimum.

The above table defines the standard products, other components may be built upon request.

High Temperature / High Voltage Capacitors

TCH Series



ELECTRICAL SPECIFICATIONS

Description	NPO	X7R
Operating temperature	-55°C to +250°C	-55°C to +250°C
Rated voltage at 20°C	200 V _{DC} to 2,000 V _{DC}	200 V _{DC} to 10,000 V _{DC}
Dielectric withstanding voltage at 20°C	1.25U _{RC} for U _{RC} = 500 V _{DC} 1.5U _{RC} for 500 V _{DC} < U _{RC} < 2,000 V _{DC} 1.3U _{RC} for U _{RC} ≥ 2,000 V _{DC}	1,000V for U _{RC} = 500 V _{DC} 1.5U _{RC} for 500 V _{DC} < U _{RC} < 2,000 V _{DC} 1.2U _{RC} for U _{RC} ≥ 2,000 V _{DC}
Capacitance	at 1MHz for C ≤ 1,000pF at 1kHz for C > 1,000pF	at 1MHz for C ≤ 100pF at 1kHz for C > 100pF
Dissipation factor at 20°C	≤ 0.015 (150/C + 7)% at 1MHz for C ≤ 50pF ≤ 0.15% at 1MHz for 50pF < C ≤ 1,000pF ≤ 0.15% at 1kHz for C > 1,000pF	≤ 2.5% at 1MHz for C ≤ 100pF ≤ 2.5% at 1kHz for C > 100pF
Dissipation factor at 200°C	≤ 0.03 (150/C + 7)% at 1MHz for C ≤ 50pF ≤ 0.3% at 1MHz for 50pF < C ≤ 1,000pF ≤ 0.3% at 1kHz for C > 1,000pF	≤ 1.5% at 1MHz for C ≤ 100pF ≤ 1.5% at 1kHz for C > 100pF
Dissipation factor at 220°C	≤ 0.03 (150/C + 7)% at 1MHz for C ≤ 50pF ≤ 0.3% at 1MHz for 50pF < C ≤ 1,000pF ≤ 0.3% at 1kHz for C > 1,000pF	≤ 0.5% at 1MHz for C ≤ 100pF ≤ 0.5% at 1kHz for C > 100pF
Dissipation factor at 250°C	≤ 0.03 (150/C + 7)% at 1MHz for C ≤ 50pF ≤ 0.3% at 1MHz for 50pF < C ≤ 1,000pF ≤ 0.3% at 1kHz for C > 1,000pF	≤ 0.5% at 1MHz for C ≤ 100pF ≤ 0.5% at 1kHz for C > 100pF
Insulation resistance at 20°C under U _{RC} for U _{RC} ≤ 500 V _{DC} under 500 V _{DC} for U _{RC} > 500 V _{DC}	≥ 100,000MΩ or ≥ 1,000MΩ.μF (whichever is less)	≥ 100,000MΩ or ≥ 1,000MΩ.μF (whichever is less)
Insulation resistance at 200°C under U _{RC} for U _{RC} ≤ 500 V _{DC} under 500 V _{DC} for U _{RC} > 500 V _{DC}	≥ 1,000MΩ or ≥ 20MΩ.μF (whichever is less)	≥ 1,000MΩ or ≥ 10MΩ.μF (whichever is less)
Insulation resistance at 220°C under U _{RC} for U _{RC} ≤ 500 V _{DC} under 500 V _{DC} for U _{RC} > 500 V _{DC}	≥ 800MΩ or ≥ 8MΩ.μF (whichever is less)	≥ 200MΩ or ≥ 4MΩ.μF (whichever is less)
Insulation resistance at 250°C under U _{RC} for U _{RC} ≤ 500 V _{DC} under 500 V _{DC} for U _{RC} > 500 V _{DC}	≥ 200MΩ or ≥ 2MΩ.μF (whichever is less)	≥ 100MΩ or ≥ 1MΩ.μF (whichever is less)
Ageing	None	≤ 2.5% per decade hour

FEATURES

- Multilayer Chips Ceramic Capacitors for operating temperature up to 250°C
- NPO and X7R dielectrics
- Capacitance range: 10pF to 15μF
- Voltage range at 20°C: 200 V_{DC} to 10 kV_{DC}

PHYSICAL CHARACTERISTICS

CONSTRUCTION

Varnished radial leaded chips capacitors for through-hole circuits.

MARKING (clear or coded)

Series, capacitance value, tolerance, voltage, date code.

HOW TO ORDER

TCH	2	85	6.8nF	20%	3,000 V
TCH2X					
TCH5X					
Series	Dielectric code	Size code	Capacitance	Tolerance	Rated voltage at 20°C
Operating temperature	1 = NPO 2 = X7R	79 80 81 82 83 84 89 85 87 88	Capacitance value in clear	For NPO dielectric: ±1% ±2% ±5% ±10% ±20% For X7R dielectric: ±10% ±20%	200 V 500 V 1 kV 2 kV 3 kV 4 kV 5 kV 7.5 kV 10 kV Intermediary and higher voltages available: contact your sales representative.

RoHS and Lead free compliant parts are available: contact your sales representative.

TCH Series

High Temperature / High Voltage Capacitors

DIMENSIONS in inches (mm)

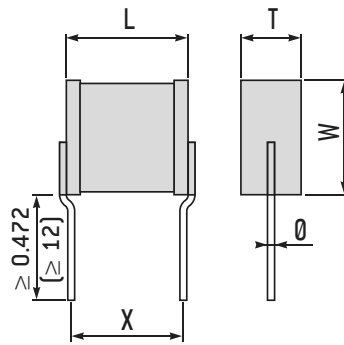

STANDARD RATINGS (NPO)

Size	1812	2220	2825	3333	4040	5440	5550	6560	11283	16080				
Excellia size code	79	80	81	82	83	84	89	85	87	88				
Dimensions inches (mm)	L max	0.237 (6)	0.276 (7)	0.355 (9)	0.394 (10)	0.473 (12)	0.63 (16)	0.642 (16.3)	0.729 (18.5)	1.182 (30)	1.674 (42.5)			
	W max	0.197 (5)	0.276 (7)	0.296 (7.5)	0.394 (10)	0.493 (12.5)	0.493 (12.5)	0.619 (15.7)	0.689 (17.5)	0.886 (22.5)	0.827 (21)			
	T max	0.138 (3.5)	0.150 (3.8)	0.237 (6)	0.237 (6)	0.237 (6)	0.237 (6)	0.237 (6)	0.237 (6)	0.256 (6.5)	0.256 (6.5)			
	0 ± 10%	0.024 (0.6)	0.024 (0.6)	0.031 (0.8)	0.031 (0.8)	0.031 (0.8)	0.039 (1)	0.039 (1)	0.039 (1)	0.039 (1)	0.039 (1)			
	X	0.2 ± 0.020 (5.08 ± 0.5)	0.2 ± 0.020 (5.08 ± 0.5)	0.3 ± 0.020 (7.62 ± 0.5)	0.4 ± 0.020 (10.16 ± 0.5)	0.5 ± 0.020 (12.7 ± 0.5)	0.6 ± 0.020 (15.24 ± 0.5)	0.6 ± 0.020 (15.24 ± 0.5)	0.7 ± 0.020 (17.8 ± 0.5)	1.1 ± 0.020 (27.94 ± 0.5)	1.6 ± 0.020 (40.64 ± 0.5)			
Min. Capacitance value		10pF	10pF	18pF	33pF	10pF	22pF	27pF	47pF	120pF	150pF			
Rated voltage (U _{RC})	20°C	200°C	220°C	250°C										
	200V	130V	100V	50V	18nF	22nF	56nF	100nF	180nF	270nF	220nF	560nF	1µF	1.2µF
	500V	330V	250V	125V	10nF	18nF	27nF	68nF	100nF	150nF	150nF	270nF	470nF	820nF
	1kV	500V	300V	200V	5.6nF	6.8nF	12nF	33nF	47nF	68nF	82nF	120nF	270nF	470nF
	2kV	1kV	650V	500V	820pF	1nF	2.7nF	6.8nF	10nF	15nF	18nF	27nF	56nF	82nF
	3kV	1.5kV	1kV	600V	390pF	470pF	1nF	1.8nF	3.3nF	5.6nF	10nF	10nF	27nF	33nF
	4kV	2kV	1.3kV	800V	220pF	330pF	820pF	1.5nF	2.7nF	4.7nF	6.8nF	8.2nF	22nF	27nF
	5kV	2.5kV	1.6kV	1kV	-	220pF	560pF	1nF	2.2nF	3.9nF	4.7nF	6.8nF	15nF	18nF
	7.5kV	3.75kV	2.5kV	1.5kV					330pF	560pF	1.2nF	1.2nF	3.3nF	4.7nF
	10kV	5kV	3kV	2kV					220pF	390pF	680pF	820pF	2.2nF	3.3nF

STANDARD RATINGS (X7R)

Size	1812	2220	2825	3333	4040	5440	5550	6560	11283	16080				
Excellia size code	79	80	81	82	83	84	89	85	87	88				
Dimensions inches (mm)	L max	0.237 (6)	0.276 (7)	0.355 (9)	0.394 (10)	0.473 (12)	0.63 (16)	0.642 (16.3)	0.729 (18.5)	1.182 (30)	1.674 (42.5)			
	W max	0.197 (5)	0.276 (7)	0.296 (7.5)	0.394 (10)	0.493 (12.5)	0.493 (12.5)	0.619 (15.7)	0.689 (17.5)	0.886 (22.5)	0.827 (21)			
	T max	0.138 (3.5)	0.150 (3.8)	0.237 (6)	0.237 (6)	0.237 (6)	0.237 (6)	0.237 (6)	0.237 (6)	0.256 (6.5)	0.256 (6.5)			
	0 ± 10%	0.024 (0.6)	0.024 (0.6)	0.031 (0.8)	0.031 (0.8)	0.031 (0.8)	0.039 (1)	0.039 (1)	0.039 (1)	0.039 (1)	0.039 (1)			
	X	0.2 ± 0.020 (5.08 ± 0.5)	0.2 ± 0.020 (5.08 ± 0.5)	0.3 ± 0.020 (7.62 ± 0.5)	0.4 ± 0.020 (10.16 ± 0.5)	0.5 ± 0.020 (12.7 ± 0.5)	0.6 ± 0.020 (15.24 ± 0.5)	0.6 ± 0.020 (15.24 ± 0.5)	0.7 ± 0.020 (17.8 ± 0.5)	1.1 ± 0.020 (27.94 ± 0.5)	1.6 ± 0.020 (40.64 ± 0.5)			
Min. Capacitance value		100pF	150pF	150pF	330pF	270pF	390pF	560pF	1nF	2.2nF	2.7nF			
Rated voltage (U _{RC})	20°C	200°C	220°C	250°C										
	200V	100V	60V	40V	220nF	390nF	820nF	1.5µF	2.7µF	3.9µF	4.7µF	6.8µF	12µF	15µF
	500V	250V	160V	100V	47nF	100nF	220nF	390nF	680nF	1µF	1.2µF	1.8µF	3.9µF	4.7µF
	1kV	500V	300V	200V	15nF	22nF	47nF	68nF	150nF	220nF	270nF	390nF	1µF	1.2µF
	2kV	1kV	650V	500V	3.3nF	5.6nF	10nF	18nF	33nF	68nF	68nF	100nF	220nF	330nF
	3kV	1.5kV	1kV	600V	1.2nF	2.2nF	3.9nF	6.8nF	15nF	27nF	27nF	39nF	100nF	120nF
	4kV	2kV	1.3kV	800V	680pF	1.2nF	2.7nF	4.7nF	10nF	15nF	18nF	27nF	68nF	100nF
	5kV	2.5kV	1.6kV	1kV	-	820pF	1.8nF	3.3nF	5.6nF	10nF	12nF	18nF	56nF	68nF
	7.5kV	3.75kV	2.5kV	1.5kV					1.5nF	2.7nF	3.3nF	6.8nF	18nF	27nF
	10kV	5kV	3kV	2kV					680pF	1.2nF	1.5nF	3.3nF	8.2nF	12nF

Available capacitance values:

NPO: E6, E12, E24 (see page 14). Specific values upon request.

X7R: E6, E12 (see page 14). Specific values upon request.

Excellia can deliver axial leads on size code 262, 263, 264, 265, 266 to allow the customer to obtain the leads spacing needed (leads spacing code = 9). In that case we recommend to bend the connections at a distance from the ceramic body of 5mm minimum.

The above table defines the standard products, other components may be built upon request.

FEED-THRU

GENERAL INFORMATION 120

TBC SERIES

Discoidal Capacitors 121

BPM SERIES

Planar Arrays 123



General Information

Discoidal capacitors with NPO, X7R ceramics (BX and BR available on request) feature unique frequency performance due to very low inductance inherent to the configuration.

They are ideally suited to interconnect power amplifier stages through a shielding wall (high impedance electronic circuits).

Silver-palladium terminations can be directly mounted on the metal surface of the shielding wall.

Multiple lines can be filtered simultaneously using the BPM Series which consist of multiple capacitors in the same component. These capacitors can have the same or different values. EXXELIA expertise and flexible manufacturing processes enable a wide range of arrays: custom configuration or geometry. Consult our Engineering team to support your design requirements.

Another version (option T) featuring central conductor configuration (illustrated below) enables to get rid of thermal and mechanical shocks inherent to lead soldering. This also eliminates the risks of plating deterioration during the soldering process.

At last 2 lines can be filtered simultaneously using the BPM 12 or BPM 22 which consists of two capacitors in the same component (4 lines with the BPM24 or BPM224). These capacitors can have the same or different values (consult us).

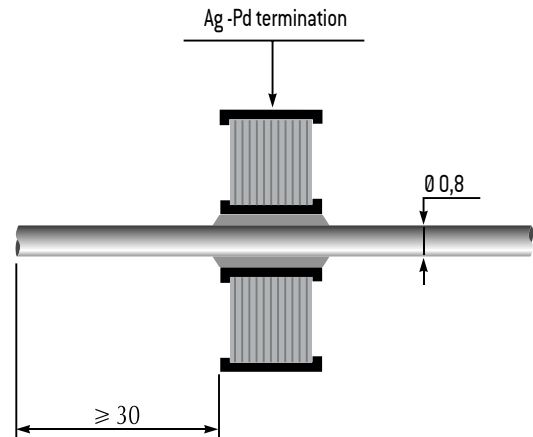

NPO: TYPICAL ATTENUATION CURVE VERSUS FREQUENCY (50Ω IMPEDANCE)

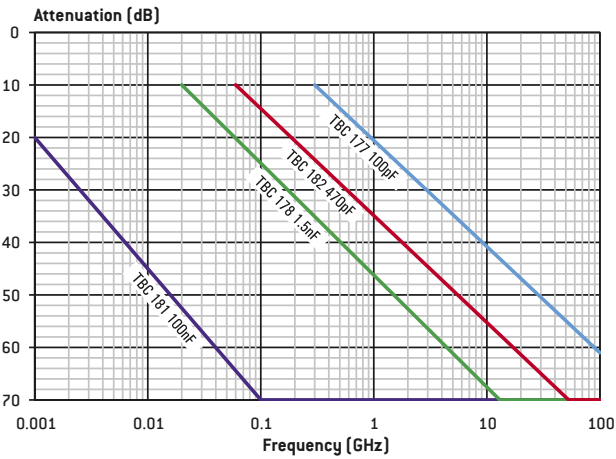

X7R: TYPICAL ATTENUATION CURVE VERSUS FREQUENCY (50Ω IMPEDANCE)

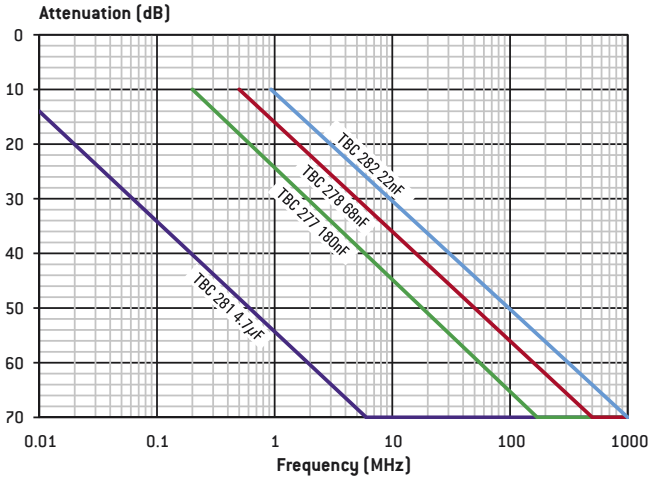

Discoidal Capacitors

TBC Series

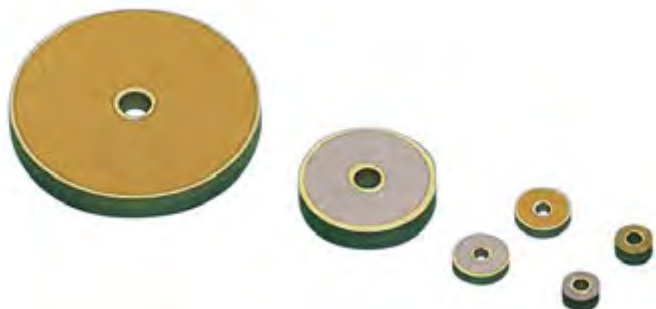

FEATURES

- Discoidal Multilayer Ceramic Capacitors
- Diameters: 0.053" [1.35 mm] – 0.61" [15.5 mm]
- NPO and X7R dielectrics
- Very low ESL
- Capacitance range: 10pF to 12µF
- Voltage range: 25V_{DC} to 1,000V_{DC}

PHYSICAL CHARACTERISTICS

CONSTRUCTION

Discoidal multilayer capacitors with Silver/Palladium/Platinum terminations.

Option T: central lead enables to get rid of thermal, mechanical shocks and plating deterioration during soldering process.

MARKING (on packaging)

Series, capacitance value, tolerance, rated voltage, batch number.

ELECTRICAL SPECIFICATIONS

Description	NPO	X7R
Operating temperature	-55°C to +125°C	-55°C to +125°C
Maximum ΔC/C over temperature range without DC voltage applied	NA	±15%
Temperature coefficient	(0±30)ppm/°C	NA
Climatic category	55 / 125 / 56	55 / 125 / 56
Dielectric withstanding voltage at 25°C	2.5 U _{RC} for U _{RC} ≤ 500V	2.5 U _{RC} for U _{RC} ≤ 500V
	1.5 U _{RC} for U _{RC} > 500V	1.5 U _{RC} for U _{RC} > 500V
Capacitance	at 1MHz for C ≤ 1,000pF	at 1MHz for C ≤ 100pF
	at 1kHz for C > 1,000pF	at 1kHz for C > 100pF
Dissipation factor at 25°C	≤ 0.015 (150/C + 7)% at 1MHz for C ≤ 50pF	
	≤ 0.15% at 1MHz for 50pF < C ≤ 1,000pF	≤ 2.5% at 1MHz for C ≤ 100pF
	≤ 0.15% at 1kHz for C > 1,000pF	≤ 2.5% at 1kHz for C > 100pF
Insulation resistance at 25°C under U _{RC} for U _{RC} ≤ 500V under 500V for U _{RC} > 500V	≥ 20,000MΩ for C ≤ 25nF	≥ 20,000MΩ for C ≤ 25nF
	≥ 500MΩ.µF for C > 25nF	≥ 500MΩ.µF for C > 25nF
Aging	None	≤ 2.5% per decade hour

BX and BR dielectrics available on request.

HOW TO ORDER

TBC	2	81	W	T	10nF	10%	100 V
Series	Dielectric code	Exxelia size code	RoHS compliant	Central conductor	Capacitance	Tolerance	Rated voltage
TBC = discoidal capacitors	1 = NPO 2 = X7R	14 82 78 99 77 12 13 81	- = No RoHS W = RoHS compliant	- = no central lead T = Central lead requested	Capacitance value in clear	NPO: ±1% (Cap. value ≥ 27pF) ±2% (Cap. value ≥ 15pF) ±5% ±10% ±20% X7R: ±10% ±20%	25 V 50 V 100 V 150 V 200 V 250 V 300 V 500 V 1,000 V

FEED-THRU

DIMENSIONS in inches (mm)

Discoidal capacitor

Discoidal capacitor with central lead

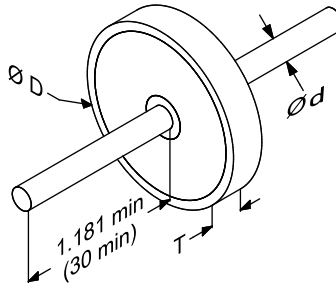
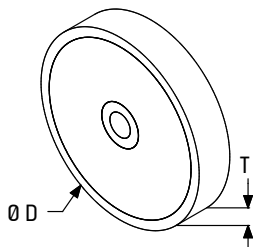

STANDARD RATINGS

Size	14		82		78		99		77		12		13		81		
Dimensions Inches (mm)	D	0.053 ± 0.002 (1.35 ± 0.05)		0.098 ± 0.008 (2.5 ± 0.2)		0.138 ± 0.008 (3.5 ± 0.2)		0.256 ± 0.008 (6.5 ± 0.2)		0.335 ± 0.008 (8.5 ± 0.2)		0.373 ± 0.005 (9.47 ± 0.13)		0.502 ± 0.008 (12.75 ± 0.2)		0.61 ± 0.008 (15.5 ± 0.2)	
	d max. Central lead	0.022 (0.55)		0.04 (1)		0.04 (1)		0.031* (0.8)		0.063 (1.6)		0.063 (1.6)		0.079 (2)		0.079 (2)	
	T max.	0.04 (1)		0.087 (2.2)		0.119 (3)		0.099 (2.5)		0.119 (3)		0.119 (3)		0.119 (3)		0.119 (3)	
Dielectric	NPO	X7R	NPO	X7R	NPO	X7R	NPO	X7R	NPO	X7R	NPO	X7R	NPO	X7R	NPO	X7R	
Exxelia dielectric code	1	2	1	2	1	2	1	2	1	2	1	2	1	2	1	2	
Min. Capacitance value	10pF	100pF	10pF	100pF	15pF	100pF	18pF	100pF	47pF	100pF	56pF	150pF	82pF	390pF	100pF	820pF	
Rated voltage [U _{dc}]	25V	100pF	2.2nF	2.7nF	82nF	12nF	390nF	68nF	1.8µF	100nF	2.7µF	120nF	3.9µF	330nF	8.2µF	390nF	12µF
	50V	100pF	1.5nF	2.7nF	56nF	12nF	330nF	68nF	1.5µF	100nF	2.2µF	120nF	3.3µF	330nF	6.8µF	390nF	10µF
	100V	56pF	470pF	1.2nF	22nF	8.2nF	100nF	39nF	560nF	68nF	1µF	100nF	1.2µF	220nF	2.7µF	330nF	3.9µF
	150V	-	-	1.0nF	12nF	5.6nF	82nF	22nF	330nF	47nF	680nF	68nF	820nF	120nF	1.8µF	180nF	2.2µF
	200V	-	-	680pF	6.8nF	3.9nF	47nF	18nF	180nF	33nF	390nF	39nF	560nF	82nF	1.2µF	120nF	1.5µF
	250V	-	-	-	-	3.3nF	39nF	12nF	120nF	22nF	270nF	33nF	390nF	68nF	820nF	82nF	1µF
	300V	-	-	-	-	2.2nF	33nF	10nF	120nF	18nF	270nF	27nF	390nF	56nF	820nF	68nF	1µF
	500V	-	-	-	-	-	-	6.8nF	68nF	15nF	150nF	18nF	220nF	39nF	470nF	56nF	560nF
	1,000V	-	-	-	-	-	-	1.5nF	15nF	3.3nF	33nF	4.7nF	47nF	10nF	100nF	12nF	120nF

* Diameter d can be increased on demand: consult your sales representative

Available capacitance values:

NPO: E6, E12, E24, E48, E96 (see page 14). Specific values upon request.

X7R: E6, E12 (see page 14). Specific values upon request.

The above table defines the standard products, other components may be built upon request.



FEATURES

- Planar capacitor arrays
- X7R dielectrics (NPO available on request)
- Capacitance range: 330pF - 68nF
- Voltage range: 25V_{DC} to 200V_{DC}
- Specific configurations available on request

PHYSICAL CHARACTERISTICS

CONSTRUCTION

Circular or rectangular multilayer capacitor arrays with Silver / Palladium / Platinum terminations. Other shapes available on request.

MARKING (on packaging)

Series, capacitance value, tolerance, rated voltage, batch number.

ELECTRICAL SPECIFICATIONS

Description	X7R
Operating temperature	-55°C to +125°C
Maximum ΔC/C over temperature range without DC voltage applied	±15%
Climatic category	55 / 125 / 56
Rated voltage (U _{RC})	25V _{DC} to 200V _{DC}
Dielectric withstanding voltage at 25°C between holes and outside	2.5 U _{RC}
Capacitance	at 1kHz
Dissipation factor at 25°C	≤ 2.5% at 1kHz
Insulation resistance at 25°C under U _{RC}	≥ 20,000MΩ
Aging	≤ 2.5% per decade hour

NPO, BX and BR dielectrics available on request.

HOW TO ORDER

BPM	22	W	470nF	10%	200 V
Series	Design code	RoHS compliant	Capacitance	Tolerance	Rated voltage
BPM = Planar arrays	22 = 2 capacitors - discoidal shape 224 = 4 capacitors - discoidal shape 24 = 4 capacitors - rectangular shape	- = No RoHS W = RoHS compliant	Capacitance value in clear	±10% ±20%	25 V 50 V 100 V 200 V

BPM Series

DIMENSIONS

Design code 22

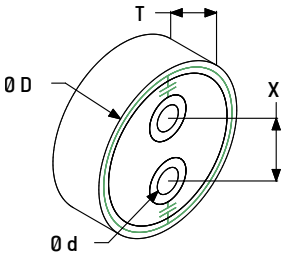

Design code 224

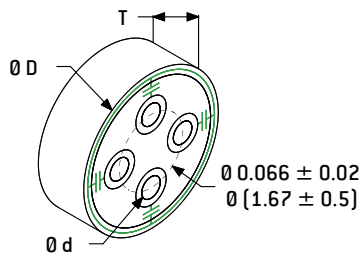

Design code 24

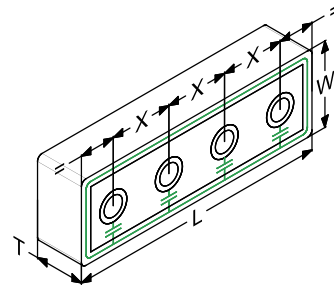

Black lines: mechanical

Green lines: electrical (external termination is connected to the ground)

STANDARD RATINGS

	Size	BPM22	BPM224	BPM24
Dimensions Inches (mm)	L ±0.008 (±0.2)	-	-	0.248 (6.3)
	W ±0.008 (±0.2)	-	-	0.081 (2.05)
	D ±0.004 (±0.1)	0.142 (3.6)	0.12 (3.05)	-
	d ±0.002 (±0.05)	0.022 (0.55)	0.019 (0.49)	-
	T max.	0.048 (1.2)	0.05 (1.25)	0.048 (1.2)
	X ± 0.002 (±0.05)	0.056 (1.42)	-	0.06 (1.52)
Min. Capacitance value		330pF	330pF	330pF
Rated voltage (U _{dc})	25V	68nF	12nF	56nF
	50V	39nF	4.7nF	27nF
	100V	18nF	2.7nF	12nF
	200V	8.2nF	-	5.6nF

Available capacitance values:

E6, E12 (see page 14). Specific values upon request.

For standard products capacitance value is the same for each hole, it can be different on request.

The above table defines the standard products, other components may be built upon request (NPO, BX, BR, shapes, number of holes, combination of capacitance values, etc.)

RF Capacitors

GENERAL INFORMATION 126

XBL SERIES

eXtra Broadband Capacitors 146

UBL SERIES

Ultra-Broadband Capacitors..... 148

UBZ SERIES

Ultra-Broadband Capacitors..... 150

CH SERIES

Classic HiQ 152

SH SERIES

Super HiQ..... 155

SHR/SHD SERIES

Reverse Geometry 158

NHB SERIES

High Self Resonant Frequency..... 160

CP SERIES

High Power 162

CL SERIES

High Power 166



General Information

CAPACITOR TERMINATIONS AND SOLDERING RECOMMENDATIONS

I. TERMINATION TYPES

Our capacitors are delivered with one of the following terminations (for technical reasons, only a limited number of termination types are available in certain cases). All our terminations are backward compatible.

Parameter	Value	Comment
Termination	A	non-magnetic (silver-palladium)
Materials	C	non-magnetic (pure tin over copper barrier)
	S	lead-free (pure tin over nickel barrier)

NB:

- terminations type C recommended for non magnetic applications.
- termination type A available for non magnetic applications (for historical reason, we have also another code, the code "P", for the same type of termination. The parts that were designed-in before 2005 might still have a code "P" instead of "A" in the part numbering. But both codes correspond to the same type of termination).

II. SPECIFICATIONS

Care must be taken when using particular terminations: if the terminations are heated up above a particular temperature and/or for too long a period of time, there is a risk of leaching (dissolution of the termination revealing the inner electrodes).

The chart below gives the resistance to soldering heat per termination type, based on a SAC387 solder bath at 260°C.

Dielectric Type	A	C	S
CHA / SHA		10 ±1s (3)	120 ±5s
CHB / SHB		30 ±2s	120 ±5s
CPX / CLX / CPE / CLE		30 ±2s	120 ±5s
CLF	10 ±2s (1)	On request	120 ±5s
SHL			120 ±5s
SHS		10 ±1s (4)	120 ±5s
SHF / SHN / SHT	5 ±1s (2)		120 ±5s

- (1): results extrapolated from 30±2s data obtained with Sn62/Pb36/Ag2 solder bath.
- (2): data obtained with Sn62/Pb36/Ag2 solder bath.
- (3): termination only available on CHA series.
- (4): preliminary data.

III. STANDARD SMD REQUIREMENTS

III.1. Soldering Recommendations

Regarding the soldering attachments, three methods are generally used: the vapor phase soldering, the infrared reflow soldering and the wave soldering. Unless particular skill about the use of the wave soldering, this method is not recommended since the melted solder is directly in contact with the ceramic. This can potentially crack the capacitor because the ceramic is sensible to the thermal shocks. Moreover, this method needs to maintain the components with an insulating resin which increases the thermo-mechanical strains between the ceramic and the board both on soldering phase and operating

condition. The vapor phase and IR reflow soldering are less aggressive, inducing more restricted thermal shocks. This is the reason why they are preferred to the wave soldering method for reliable applications. In all cases, proper pre-heating is essential.

The circuit should be pre-heated at a typical rate of 1°C/s within 65°C to 100°C of the maximum soldering temperature. While multilayer ceramic capacitors can withstand the peak soldering temperatures for short durations, they should be minimized whenever possible.

Above precaution given for SMD types are applicable for the implementation of large bare chips (1515 and above). But in general, large bare chips above 2225 are not recommended to be mounted on epoxy printed board due to the thermal expansion mismatch between ceramic capacitor body and epoxy. This is the reason why leaded components will be preferred especially for reliable applications.

For information, the typical thermal profiles of these three soldering processes are given hereafter. These typical diagrams are only given as an aid to SMD users in determining specific processes linked to their instrumentations and to their own experience.

NB: reference documents are IEC 61760-1, CECC30000 and IEC68 standards. Please, refer to this standard for more information.

III.1.1. Vapour Phase Soldering

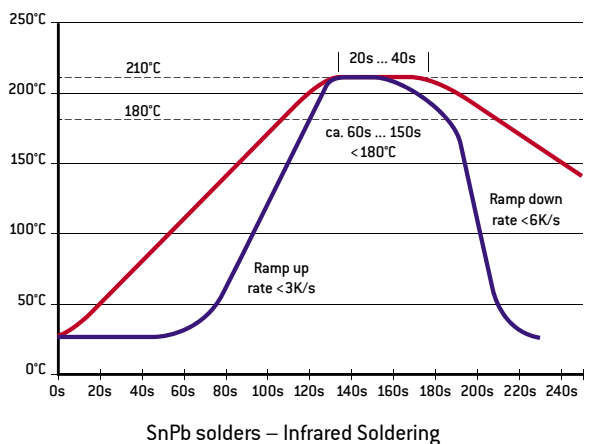
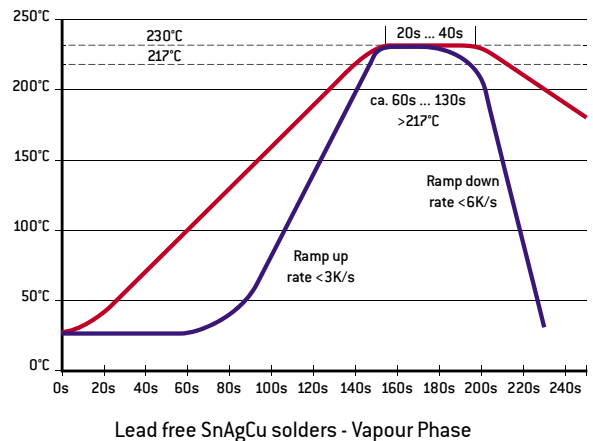

NB: the lines indicate the upper and lower limits of typical process (terminal temperature).

General Information

III.1.2. Infrared Soldering

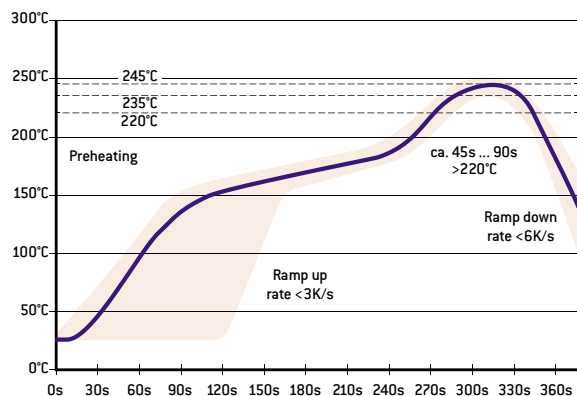

Lead free SnAgCu solders – Infrared Soldering

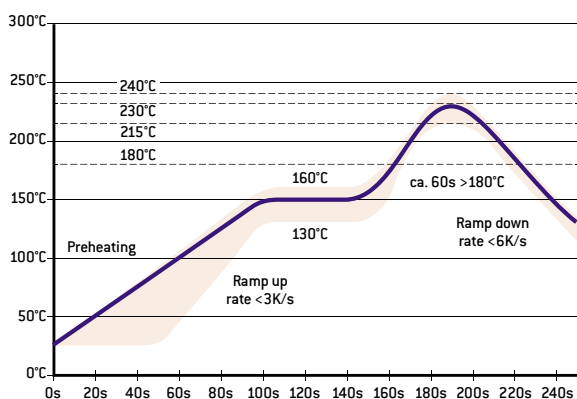

SnPb solders – Infrared Soldering

NB:

- these profiles are given for mid size components.
- continuous lines: typical process (terminal temperature).
- dotted lines: process limits, bottom process limit (terminal temperature), upper process limit (top surface temperature).

III.1.3. Wave Soldering

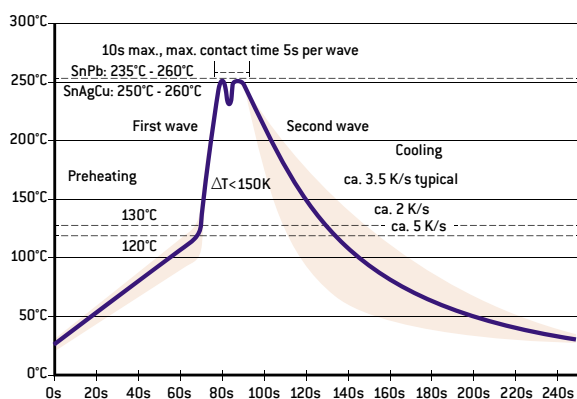

SnAgCu and SnPb solders - Double Wave Soldering

- NB:
- continuous lines: typical process.
 - dotted lines: process limits.

III.2. Moisture Sensitivity Classification

Our standard lead-free terminations - S and C types - have been fully tested and are compliant with the requirements mentioned in specification JEDEC STD 020 (level 1: not moisture sensitive).

III.3. Whiskers Classification

Our standard lead-free terminations - S and C types - have been fully tested and are compliant with the requirements mentioned in specification JEDEC STD 201. Our terminations exhibit a matte finish and receive a special heat treatment to relieve stress inside the tin.

III.4. Pad Dimensions

The metalized pads on the end user's substrate must be properly designed. Improper spacing or dimensioning of the pads may result in poor solder joints or a tombstone effect. Pad designs are given below for the most common sizes of multilayer ceramic capacitors for both wave and reflow soldering.

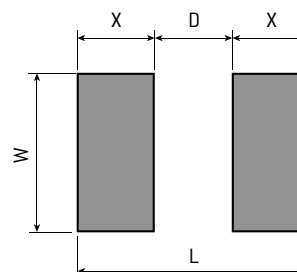

Case Size	W	X	D	L
SHL (0402)	0.70mm	0.90mm	0.40mm	2.20mm
CHA / SHA (0505)	1.80mm	1.00mm	0.80mm	2.80mm
SHS (0603)	1.00mm	1.10mm	0.60mm	2.80mm
SHF (0805)	1.50mm	1.30mm	0.60mm	3.20mm
CHB / SHB (1111)	3.00mm	1.00mm	1.90mm	3.90mm
CPX / CLX (2225)	6.90mm	1.00mm	5.00mm	7.00mm
CPE / CLE (4040)	10.20mm	1.10mm	8.30mm	10.50mm

NB: these dimensions are suggested for a reflow soldering process. If a wave soldering process is used, the X dimension has to be increased by 0.50mm (0.40mm for L and A case sizes), thus leading to an increase of 1.00mm to the L dimension (0.80mm for L and A case sizes).

General Information

SERIAL AND PARALLEL RESONANCE FREQUENCIES (SRF & PRF) OF CAPACITORS ON PCB

I. INTRODUCTION AND DEFINITIONS

The equivalent model for a capacitor is usually defined by the figure 1 where:

- C** is the capacitance of the Capacitor
- RS** is the equivalent serial resistance (ESR)
- L** is the equivalent serial inductance (ESL)
- Cp** is the parasitic parallel capacitance
- Rp** is the Insulation Resistance

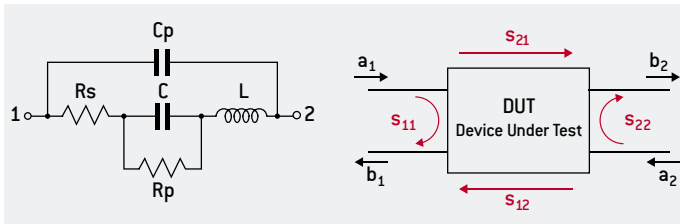

Figure 1: Equivalent Model

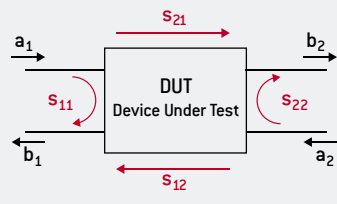
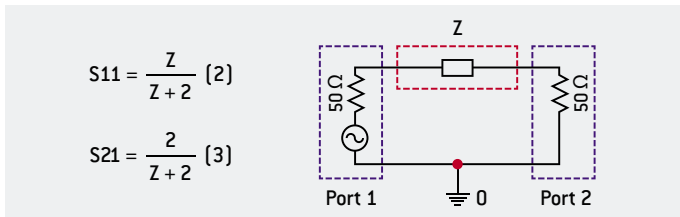

Figure 2: S parameters

The complex impedance Z is defined by:

$$Z = ESR + jX \text{ and } z = Z/Z_0 \text{ (1) where } z \text{ is the reduced impedance, } X \text{ the reactance, } Z_0 \text{ the characteristic impedance (usually 50 ohm)}$$

The impedance can be determined by the S parameters (figure 2) measurement for example with a serial configuration (Figure 3)



$$S_{11} = \frac{Z}{Z + 2} \text{ (2)}$$

$$S_{21} = \frac{2}{Z + 2} \text{ (3)}$$

Figure 3: DUT Serial measurements

The variation of S11 (figure 4) and S21 (figure 5) show the different resonance frequencies SRF (serial resonance frequency) and PRF (parallel resonance frequency)

- The SRF is defined when the capacitor is a pure very small resistance:

$$SRF = \frac{1}{2\pi\sqrt{LC}} \text{ (4a)}$$

Therefore as X=0 the impedance defined in (1) is:

$$Z = ESR \text{ (5)}$$

At this frequency the ESR is usually low.

For example for a 251SHF150 (size 0805 and capacitance 15pf): SRF=2.64 GHz and the ESR at this frequency is 0.200 ohm (figure 5)

- The PRF is associated with the parasitic capacitance Cp defined in figure 1. Assuming that Cp << C, then:

$$PRF \approx \frac{1}{2\pi\sqrt{LC_p}} \text{ (4b)}$$

At this frequency the impedance is a pure very high resistance.

For example for a 251SHF150:

PRF=3.66 GHz and the ESR at this frequency is very high (figure 6)

The PRF could be determined by the S21 measurements (figure 5)

The lumped model shown in Fig. 1 explains only the existence of one serial self-resonant frequency and one parallel self-resonant frequency, consequently, the lumped model is unable to explain why real measurements exhibits a double infinity of self-resonant frequencies (see figures 4, 5 & 6).

It is currently admitted [Ref. 1] that the lumped model shown in Fig. 1 is convenient only for frequencies that are lower than roughly the half of the first SRF. For frequencies close or above the first SRF, it is mandatory to consider the distributed model or transmission line model [Ref. 1].

This distributed model can be established more easily with the equivalent circuit of a Single Layer Capacitor (SLC) shown in Fig. 7:

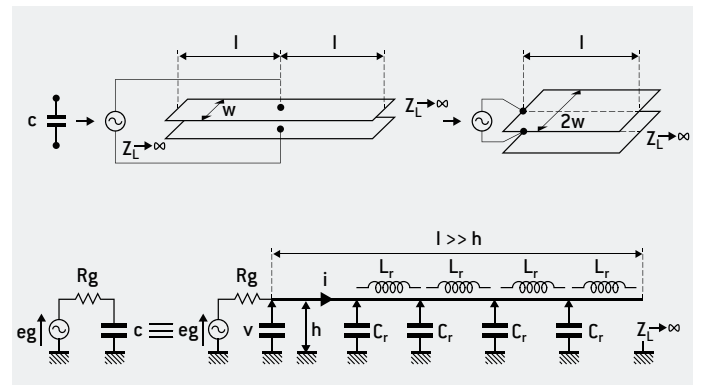

Figure 7: Transmission line model of a Single Layer Capacitor

After examination of Fig. 7, one can see that a Single Layer Capacitor can be modeled by a transmission line with an open termination that is currently called an "open stub".

According to classical courses relatives to transmission lines theory, it is well known that the variation with frequency of the input impedance of an open stub is given by:

$$Z_e = -jZ_c \cdot \cot g \left(\frac{2\pi l}{\lambda} \right) = -jZ_c \cdot \cot g \left(\frac{2\pi l}{c} f \right) \text{ (5)}$$

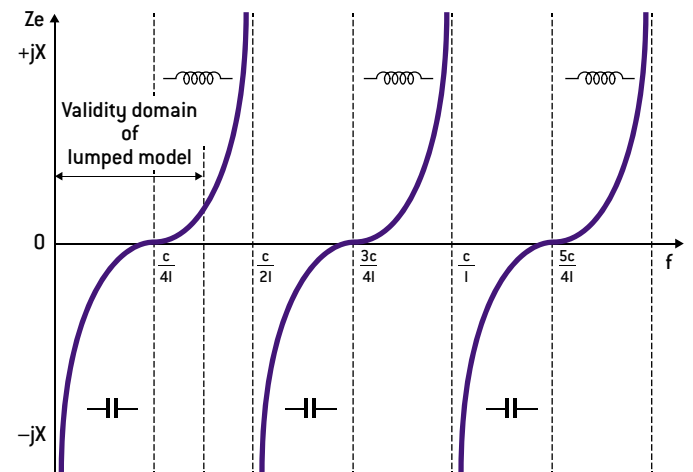

Figure 8: Plot of the theoretical expression (5) of the impedance of a Single Layer Capacitor modeled by an open stub

General Information

The plot of the theoretical expression (5) of the impedance of a Single Layer Capacitor is shown in Fig. 8. As one can see, this theoretical curve predicts a double infinity of self-resonant frequencies (alternances of serial and parallel resonances) that are identical to the ones encountered in real world measurements.

Consequently, for predicting and understanding the behavior of a capacitor at frequencies that are close or above the first SRF, the lumped model (shown in Fig. 1) is not applicable and must be replaced by the distributed model or transmission line model (shown in Fig. 7).

Furthermore, according to [1], the transmission line model predicts accurately that the serial or parallel self-resonances are doubled when a capacitor chip is mounted with its internal electrodes oriented vertically (once again, it is impossible to predict such a phenomenon with the lumped model).

If now we take a closer look at a capacitor used as a coupling capacitor in a wide band application, it is evident when looking at fig. 8 that the coupling function will be correctly fulfilled at frequencies close to the serial resonant frequencies, since the capacitor's impedance is very low.

Conversely, the contrary will be encountered at the parallel resonant frequencies since the capacitor's impedance is very high and consequently the coupling function is not fulfilled.

Therefore in the application we must avoid to be at PRF. The High ESR may involve power loss and increase of internal temperature, since:

$$P = ESR I^2 \quad [6]$$

$$P = \frac{\Delta T}{R_{TH}} \quad (\text{stationary state}) \quad [7]$$

The temperature increase is therefore:

$$\Delta T = ESR I^2 R_{TH} \quad [8]$$

Where Rth is the thermal resistance of the capacitor with the PCB.

At first glance, equations (6), (7) & (8) confirm an increase of the internal temperature, but a closer look at these equations reveals that this temperature rise takes place only if the current I is constant. The problem is that in real applications the power source is rarely a pure current generator. More often than none, the power source is the dual of a current generator i.e. a pure voltage generator. In the case of a circuit powered by a pure voltage generator, the contrary of the preceding behavior will be encountered at PRF since, as the capacitor's impedance is very high, the current I is very low and consequently, according to (6), (7) & (8) the temperature rise is not obvious or may be a temperature fall.

From these considerations, one can draw the conclusion that when a coupling capacitor is used at its PRF, for predicting an eventual temperature rise it is also mandatory to know for the PRF the behavior of the generator and the load between which the coupling capacitor is serially inserted.

In other words, the coupling capacitor is not the only cause of a temperature rise and consequently, the characteristics of the whole circuitry must be well known and understood prior to investigate the reasons of a temperature rise.

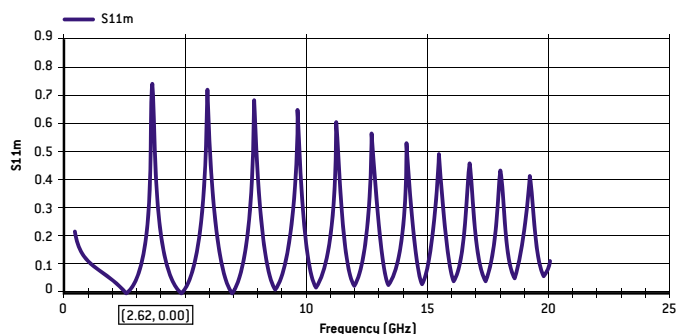

Figure 4: S11curve for a 251SHF150 from EXXELIA ABC software

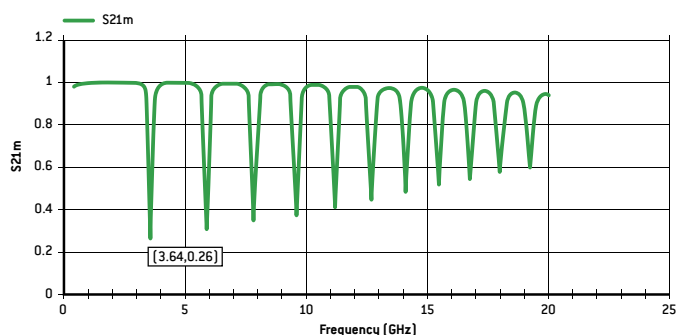

Figure 5: S21curve for a 251SHF150 from EXXELIA ABC software

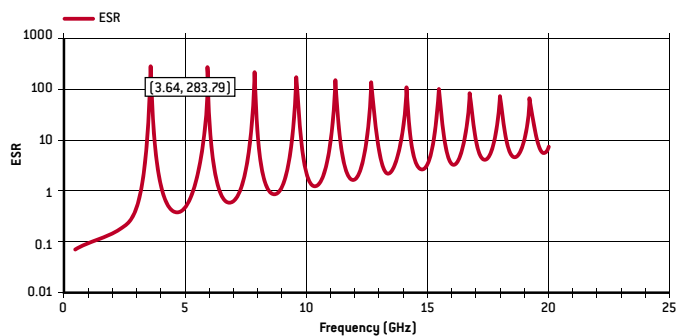

Figure 6: ESR curve for a 251SHF150 from EXXELIA ABC software

General Information

II. PARAMETERS OF SUBSTRATES AND CAPACITORS WHICH INFLUENCES THE PRF

As the PRF is linked to the parasitic parallel capacitance, when the capacitor is mounted on a PCB, the main parameters which could influence the PRF are:

- PCB parameters
- Capacitor parameters
 - Capacitance value
 - Geometry and size
 - Electrode orientation (horizontal or vertical)
 - Internal design

For example in the following screen plots, we can see that the first PRF is about 1.8GHz when the capacitor is mounted horizontally and is not visible when it is mounted vertically.

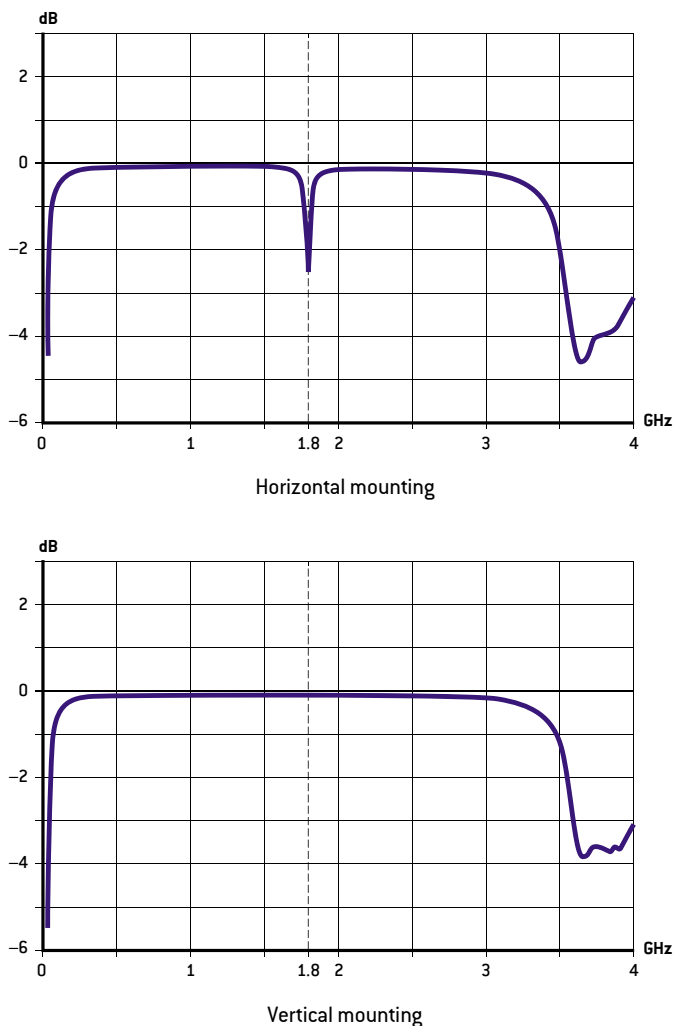

Figure 9: Example of PRF measurement (501SHB390JS on a FR4 PCB horizontal and vertical mounting)

[Ref.1] Monolithic Capacitors as Transmission Lines. Marc INGALLS and Gordon KENT IEE Transactions on Microwaves Theory and Techniques, Vol. MTT-35, N°11 november1987, pp. 964-970.

STYLES, RF & AMP; MICROWAVE SYSTEMS

I. TYPICAL RELIABILITY TESTS

- Adhesive Strength of Termination
- Bending Strength
- Solderability of Termination
- Resistance to Soldering Heat
- Thermal shock -55°C to +125°C
- Humidity Load (240 hours, 85% relative humidity at +85°C)
- High Temperature Load (1000/2000h, 125°C, x U_N)

II. RELIABILITY DATA MONITORING

II.1. General Manufacturing Process

At each step of the manufacturing process, specific checks have been set-up to guarantee the quality level of our products. Statistical Process Controls (also known as SPC) are utilized to monitor key parameters within processes.

In addition to all these in-process controls, a sample of capacitors from each lot is micro-sectioned to check the internal structure and the absence of voids, delaminations, cracks or other defects.

When manufacturing is completed, the multilayer ceramic capacitors are fully screened for Capacitance, Dissipation Factor, Dielectric Withstanding Voltage, Insulation Resistance and Visual Defects.

II.2. Reliability Testing

During qualification of new capacitor series or at random intervals, EXXELIA performs life tests – 2,000 hours, +125°C, 2 x WV_{DC} - and uses MIL-PRF-55681 as a guideline. The following parameters best describe our multilayer ceramic capacitors for military applications:

- data from MIL-PRF- 55681 revision F;
- capacitor, chip, multiple layer, fixed, ceramic dielectric, established reliability;
- rated temperature: -55°C to +125°C;
- CDR11, CDR12, CDR13 and CDR14 case sizes;
- Failure Rate levels C, M, P, R and S.

The data obtained from our continuous life test monitoring are used to calculate an equivalent part failure rate and to compare it to the Failure Rate level as defined in MIL-PRF-55681F. The methods and formulae used are based on MIL-HDBK271F and MIL-STD-690D.

An acceleration factor of 8:1 is used to relate life test data obtained at 200% rated voltage at maximum rated temperature, to rated voltage at maximum rated temperature (125°C). The following formula is used:

$$AF = \left(\frac{V}{V_0} \right)^3 \times 2^{\frac{T-T_0}{10}}$$

where V₀ is the rated voltage, T₀ the rated temperature, V and T the life test parameters.

III. RELIABILITY DATA SUMMARY

As stated in MIL-STD- 690D, data are accumulated from sample units selected from a production run and produced with equipment and procedures normally used in production. One of the prerequisites for valid data is that all lots produced during the production period be represented. The data are from the same product in current production, i.e. data from products of preceding designs are not acceptable.

III.1. Failure Rate Level

CAPACITOR RELIABILITY DATA MIL-STD CDR

General Information

The summary of all collected data gives the following results:

- cumulative unit hours in millions: 9.27;
- cumulative unit hours in millions with acceleration factor: 74.16;
- number of defects: 1.

We consider a single sampling plan based on a 90 percent confidence level: FRSP-90. For this FR sampling plan, MIL-STD- 690D gives the following criteria:

FR Level Symbol	Qualified FR Level (% per 1,000 hours)	Number of Failures Permitted
C	non-ER	N/A
M	1.0	1 over 0.389M hours
P	0.1	1 over 3.89M hours
R	0.01	1 over 38.9M hours
S	0.001	1 over 389M hours

EXXELIA Temex therefore complies with the requirements of C, M, P and R failure rate levels.

S failure rate level according to European Space Agency specifications 3009/035 and 3009/036.

III.2. Mean Time To Failure

MTTF is the basic measure of reliability for non-repairable items. It is analogous to the more familiar MTBF (Mean Time Between Failures) used for systems which can be repaired and placed back in service after failure occurs. FR levels may be converted to mean time to failure (MTTF) as follows:

$$MTTF = \frac{100\,000}{FR_level}, \text{ in failure per } 10^6 \text{ hours}$$

III.3. Unit Hour Requirement

A complete Poisson distribution table is needed to compute unit hours. To calculate unit hours with a given number “C” of permitted failures (we are considering 1 permitted failure) we first have to determine the probability of acceptance P_a by subtracting the FRSP value (0.90 as we have selected a confidence level of 90%) from 1.

Example: P_a = 1 – 0.90 = 0.10

From Poisson's table and for a Failure Rate level M, we find for the parameters “C” and P_a equal respectively to 1 and 0.10 the corresponding “m” value of 3.89; this “m” value in the table is the total of failure rate λ multiplied by the time (test hours).

$$M = \lambda \times t$$

unit hours = m ÷ λ [1%/1,000hours as we are working with FR level M]
 unit hours = 3.89 ÷ 0.00001 = 0.389 million hours (around 45 years)
 Values for P, R and S levels are found by multiplying the previous level by 10.

IV. PART FAILURE RATE

The Part Failure Rate as defined by MIL-HDBK- 217F is given by the following formula:

$$\lambda_p = \lambda_b \cdot \pi_{CV} \cdot \pi_Q \cdot \pi_E$$

where:

- λ_b is the Base Failure Rate;
- π_{CV} is the Capacitance Factor;
- π_Q is Quality Factor;
- π_E is the Environment Factor.

The Part Failure Rate, considering the capacitor series meet the required FR level, gives the number of failures per 10⁶ hours. In MIL-HDBK-217F, the values for all these parameters are given under Capacitors, Fixed, Ceramic, Temperature Compensating and Chip paragraph. The CDR style as described by MIL-PRF-55681F is taken into account and corresponds to EXXELIA CHA and CHB sizes.

IV.1. Quality Factor

The Quality Factor depends on the FR level. If we consider the three FR levels defined previously for EXXELIA multilayer capacitors, the given factors are:

Symbol	Product Level	π _Q
C	non-ER	3.0
M	1.0 % per 1,000 hours	1.0
P	0.1 % per 1,000 hours	0.3

IV.2. Environment Factor

All part reliability models include the effects of environmental stresses through the Environmental Factor. The descriptions of these environments are shown below and encompass the major areas of equipment use

Environment	Description	π _E
G _B : Ground, Benign	Non-mobile, temperature and humidity controlled environments readily accessed to maintenance; includes laboratory instruments and test equipment, medical electronic equipment, business and scientific computer complexes, and missiles and support equipment in ground silos.	1.0
G _F : Ground, Fixed	Moderately controlled environments such as installation in permanent racks with adequate cooling air and possible installation in unheated buildings; includes permanent installation of air traffic control radar and communications facilities.	2.0
G _M : Ground, Mobile	Equipment installed on wheeled or tracked vehicles and equipment manually transported; includes tactical missile ground support equipment, mobile communication equipment, tactical fire direction systems, handheld communications equipment, laser designations and range finders.	10.0

IV.3. Part Failure Rate Calculation

The part failure rate calculated as specified in MIL-HDBK-217F provides a more accurate result than the standard failure rate given by a particular FR level. The two main parameters are the FR level achieved by the standard process – Quality Factor - and the application where the part will be used – Environment Factor. Specific study could be made on request based on customer's requirements and equipments.

General Information

POWER CAPACITOR SOLUTIONS ULTRA-LOW ESR, HIGH RF POWER

In the RF world, one trend that continues to gain momentum is the need for higher RF output power in amplifier modules and systems. Associated to a growing demand for reduced unit size, the task for the designers and the component manufacturers is challenging.

First of all, the systems have to deal with higher RF power. At the component level, this means that a particular function which required only a single component previously has now to evolve to a sub-system made of several components to handle the total amount of power.



Example of capacitor Module

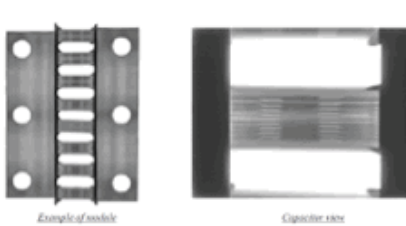

Example of X-Rays analysis

Moreover, the reduction of the unit size led to higher operating temperatures, adding severe requirements on the components. They have to survive higher temperatures, being able to dissipate the generated heat – small packages produce much higher power densities – maintain their performances among huge operating temperature variations and offer mechanical flexibility to accept significant PCB thermal expansion.

Now, when coming to the capacitor world, these new needs will affect the “single-chip” standard model. For instance, when one capacitor was enough to ensure the matching of a 100 W RF transistor, the recent 1'000W transistors need “n” capacitors, even sometimes with an increased size.

In order to get a better understanding of these new requirements and to study the “n-chip” model, we will first look at the key parameters of high RF power systems. Then, depending on the key parameter(s) considered, we will see which Power Capacitor Solution is best-tailored to the designer needs.

I. HIGH RF POWER

I.1. Voltage Rating

Maximum voltage ratings for ceramic capacitors (W_{DC}) are linked to two factors: strength of the dielectric and Paschen's law. The strength of the dielectric provides a maximum voltage breakdown and the Paschen's law provides another maximum voltage above which the air around the chip arcs.

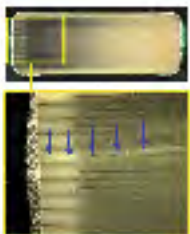

Strength of Dielectric



Paschen's Law

The voltage rating of the ceramic capacitor is then defined as the lowest value when considering both limitations.

I.1.1. Dielectric Strength

The capacitor maximum voltage rating is determined predominantly by the dielectric strength or voltage breakdown characteristics. For instance, porcelain dielectrics exhibit a breakdown voltage that typically exceeds 1'000 $kV_{DC}/inch$ of dielectric thickness.

Material	Dielectric Strength (kV/inch)
Vacuum	20
Air	20 to 75
Porcelain	40 to 200
Glass	2'000 to 3'000
Mica	5'000

For multilayer capacitors for instance, this means that one particular layer of standard dielectric – let's consider a theoretical 5 mils thick layer – will not crack until the voltage exceeds a value around 5'000 V_{DC} . In order to achieve even higher voltage ratings, specific internal electrode designs are used to split the voltage.

I.1.2. Paschen's Law

In 1889, F. Paschen published a paper (Wied. Ann., 37, 69) which set out what has become known as Paschen's Law. The law essentially states that the breakdown characteristics of a gap are a function [generally not linear] of the product of the gas pressure and the gap length, usually written as $V = f(pd)$, where p is the pressure [in Torr] and d is the gap distance [in cm]:

$$V = \frac{365 \times p \times d}{1.18 + \ln(p \times d)} \quad (1)$$

Note: 1 bar = 100'000 Pa = 750 Torr = 14.5 psi.

For instance, if we consider an E-type capacitor (CLE series with an EIA chip size of 4040), the length between the two terminations (“L” as shown below) is around 10.50 mm.

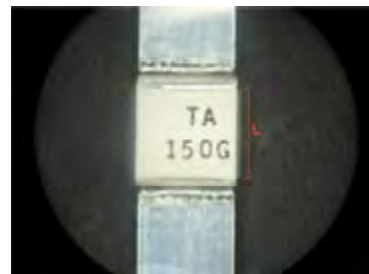

This means, using the Paschen's law ($p=750$ Torr; $d=1.05$ cm), that if the voltage across such equivalent air gap exceeds 36'600Vdc, an electric arc would be created. However, when dealing with the gap between the two capacitor terminations, another parameter has to be considered. Actually, as the dielectric material is charged, there is an ionization of air which influences the Paschen's law. Therefore, for the capacitor considered in this example, a voltage around 10'000 V_{DC} will probably create a short circuit on the capacitor external surface (carbon residues from the arcing). Moreover, the electric arc itself could damage nearby components.

For applications where very high voltages are needed, a specific coating would be applied on the capacitor, thus covering both terminations. In this case, the gap itself disappears and no electric arc could occur.

I.2. Current Rating

The current rating assigned to a capacitor is stated in one of two ways: voltage limited or power dissipation limited. The rating that applies depends on the capacitance value and operating frequency. The voltage limited area is based on the voltage rating. The power dissipation limited area is based on the ability of the capacitor to dissipate the heat. The current rating of the ceramic capacitor is then the lowest value.

General Information

I.2.1. Voltage Limit

The maximum current for the voltage limited operating condition is directly proportional to the capacitor voltage rating and the impedance:

$$I_{vm} = WV_{DC} \times \sqrt{2} / Z \quad (2)$$

$$Z = \sqrt{ESR^2 + (L\omega - 1/C\omega)^2} \quad (3)$$

When the frequency is enough low and ESR negligible:

$$Z \approx (1/C\omega) \quad (4)$$

$$\text{Then } I_{vm} \approx 2\pi \times WV_{DC} \times \sqrt{2} \times f \times C \quad (5)$$

I.2.2. Power Dissipation Limit

The maximum RMS current for the power dissipation limited operating condition is directly proportional to the maximum power dissipation of the device and the Equivalent Series Resistance:

$$I_{p(RMS)} = \sqrt{\frac{Pd_{max}}{ESR}} \quad (6)$$

Pd_{max} is the maximum power dissipation of the device as defined in reference to a given mounting surface with known characteristics. The thermal resistance (Θ_C) of a ceramic capacitor operating in a given application is a key factor to establish the device power rating:

$$Pd_{max} = \frac{T_{max} - T_{amb.}}{\Theta_c} \quad (7)$$

I.2.3. Maximum current

The maximum current is :

$$I_{max} = \text{minimum} (\sqrt{I_{p(RMS)}}, I_{vm})$$

Considering the general trend of the current with the frequency:

(5) shows that I_{vm} increases with the frequency

(6) shows that $I_{p(RMS)}$ decreases with the frequency (ESR increases with frequencies in a general trend with skin effect)

Therefore typically the maximum current is limited

- By I_{vm} at low frequencies
- By $I_{p(RMS)}$ at higher frequencies

I.3. HEAT TRANSFER

I.3.1. Thermal Convection

Convection is a heat transfer produced by the motion of a mass of fluid such as air or water when the heated fluid is caused to move away from the source of heat, carrying energy with it. Convection above a hot surface occurs because at constant pressure, hot air expands, becomes less dense, and rises.

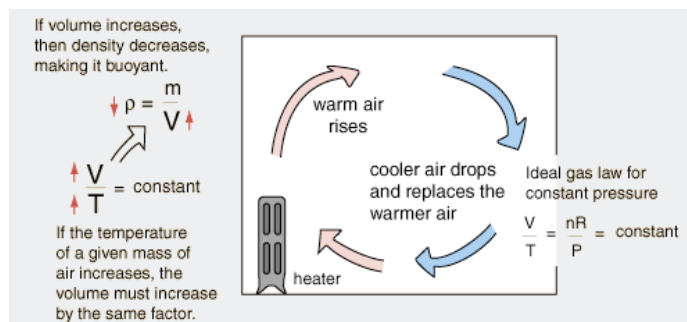

I.3.2. Thermal Radiation

Radiation is a heat transfer produced by the emission of electromagnetic waves which carry energy away from the emitting object. For ordinary temperatures, the radiation is in the infrared region of the electromagnetic spectrum. The relationship governing radiation from hot objects is called the Stefan-Boltzmann law:

$$P = \epsilon \times \sigma \times A \times (T^4 - T_c^4) \quad (8)$$

Where:

- P is the net radiated power
- ϵ is the emissivity coefficient (1 for ideal radiator)
- σ is the Stefan's constant (5.6703.10-8 W/m².K⁴)
- A is the radiating area
- T is the temperature of radiator
- T_c is the ambient temperature

I.3.3. Thermal Conduction

Conduction is a heat transfer by means of molecular agitation within a material without any motion of the material as a whole. If one end of a metal rod is at a higher temperature, then energy will be transferred down the rod toward the colder end because the higher speed particles will collide with the slower ones with a net transfer of energy to the slower ones.

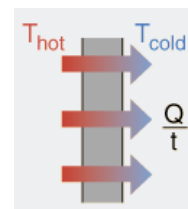

For a heat transfer between two flat surfaces, such as heat loss through the wall of a house, the rate of conduction heat transfer is:

$$\frac{Q}{t} = \frac{K \times A \times (T_{hot} - T_{cold})}{d} \quad (9)$$

Where:

- Q is the heat transferred with the time t
- K is the thermal conductivity of the barrier
- A is the conducting area
- T is the temperature
- d is the thickness of the barrier

Conceptually, the thermal conductivity can be thought as the rate of heat loss per unit area to the rate of change of temperature.

$$\frac{dQ}{dtA} = -\kappa \nabla T \quad (10)$$

The net heat transfer is in the opposite direction of the temperature gradient

General Information

For a stationary state and without internal heat source: [1]

$\nabla^2 T = 0$ therefore for one dimensional equation $T = Ax + B$ (A and B are constants)

Considering the following capacitor where

T_{max} is the maximum temperature of capacitor (°C) located at the center of the capacitor

T_{amb} is the application ambient temperature in operating conditions (°C) located at both terminations if the thermal transfer of the connections is enough efficient.

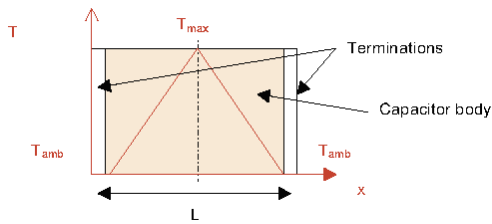

Temperature profile inside the capacitor

The thermal resistance θ_c of the capacitor is composed on two parallel thermal resistance θ :

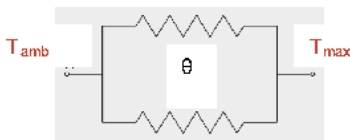

The thermal resistance θ_c of the capacitor is:

$$\frac{1}{\theta_c} = \frac{2}{\theta} \quad [11]$$

and

$$\theta = \frac{L/2}{A \times \lambda} \quad [12]$$

therefore

$$\theta_c = \frac{L}{4 \times A \times \lambda} \quad [13]$$

Where

λ is the coefficient of thermal conductivity of the ceramic body $W.cm^{-1}.C^{-1}$

A is the section surface (thickness x width) $[cm^2]$

L is the length of the capacitor $[cm]$

The geometry of the capacitor (A/S) influences the thermal resistance. For example 0711 size (Exxelia reference=SHD) has a factor A/S more beneficial than 1111 size to reduce thermal resistance of the capacitor.

Considering the non-stationary state, we must solve equation (10). For example if we consider a capacitor an initial temperature T_{amb} and a final temperature T_{max} , we may use the following equation for the temperature evolution: [2]

$$T(t) = T_{max} - (T_{max} - T_{amb}) \exp\left(-\frac{t}{mC_p\theta_c}\right) \quad [14]$$

Where :

m is the mass of the capacitor

C_p is the thermal capacity

θ_c is the capacitor thermal resistance

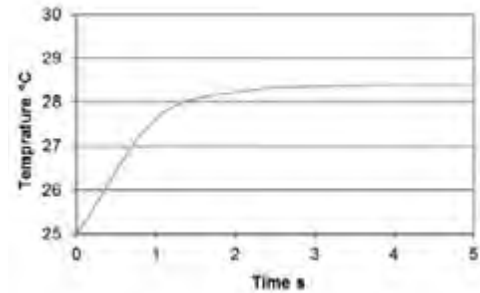

Example of the temperature evolution inside the capacitor where $T_{amb} = 25^\circ C$ and $T_{max} = 28.3^\circ C$

I.4. Global Power Model

All the above parameters have to be kept in mind when designing a high RF power function. The capacitors used in the application should be fine-tuned to make sure their voltage rating, their current rating and their heat transfer capabilities are in line with the required specifications. Moreover, the specifications do not only include the capacitor by itself, but also the PCB properties and the environment where the complete system operates.

Let's consider for instance the Global Power Model of a single capacitor mounted on a PCB studied at a working frequency of 50 MHz.

The component characteristics are as-follows:

Type: EXXELIA CLE series

Voltage rating: 7'000 V_{DC}

Capacitance value: 22 pF

First, the size of the component will give the capacitor thermal resistance – its ability to dissipate heat. Then, in the PCB specification, we will look for its thermal resistance properties. The environment – how the system is working in normal/maximum operation – will tell us the theoretical ambient temperature. Finally, the capacitor electrical parameters will be used – capacitance value, voltage rating and ESR.

All these data are compelled in a simulation program which calculates the maximum current rating of the capacitor for the considered system, at one particular frequency:

Designation of the part: 702 CLE 220 G5LF	
Select the capacitor type:	CLE
Capacitor Length:	10.50 mm
Capacitor Width:	9.50 mm
Capacitor Height:	4.50 mm
Capacitor thermal resistance:	10.23 °C/W
PCB thermal resistance:	7.37 °C/W
Capacitor max operating temperature:	125 °C
Ambient temperature:	25 °C
Capacitance value:	22 pF
Rated DC voltage:	7 000 V
Frequency:	50.00 MHz
Duty Cycle:	5 %
ESR @ Frequency:	0.042 Ohms
The maximum power given by the The maximum current in The maximum voltage	Voltage 34.210 Arms 4.950 Wmax

As previously written, the current rating assigned to a capacitor is stated in one of two ways: voltage limited or power dissipation limited. The software calculates both limitations: I_v for the voltage and I_p for the power. Finally, the smallest value is taken as it represents the first limitation the user will reach when using the system.

General Information

In the example above at 50MHz, the capacitor, according to its power dissipation limitation, should handle around 52A (Ip) but the voltage limitation will actually not allow it to handle more than 34A (Iv). If the capacitance function has to handle more current, then the designer has to switch to the "n-chip" model and to use a combination of several capacitors, a.k.a as Power Capacitor Solutions.

II. POWER CAPACITOR SOLUTIONS

More RF power means either a higher current or a higher voltage, sometimes both. As the current and voltage laws are quite fixed for capacitors – physical limitations give few options on dielectric thickness and number of electrodes which are key to handle more power in a single component – the only way to handle more power, for a given ultra-low ESR series, is to increase the number of capacitors.

This led to a new branch of capacitor knowledge dedicated to thermal and power analysis, mechanical assembly, high temperature PCB soldering and specific RF test procedures.

The Power Capacitor Solutions are especially dedicated to applications where high reliability, high operating voltages, high operating currents, ultra-low ESR and tighter tolerances are required. Most of these applications are found in the following markets:

- Medical Electronics;
- Broadcasting Equipment;
- Semiconductor Manufacturing;
- Inductive Heating;
- LASER Power Supplies;
- MRI High Magnetic Environments;
- Military Systems.

II.1. Parallel Combinations

To deal with a higher operating current or to further reduce our ultra-low ESR, one can use combinations of HiQ ceramic capacitors in parallel – current rating multiplied.



II.2. Series Combinations

To deal with a higher operating voltage, one can use combinations of HiQ ceramic capacitors in series, within the same dielectric die or using separate entities – voltage rating multiplied.



II.3. Matched Sets

To achieve non-standard total capacitance values or ultra-tight tolerances, EXXELIA can match capacitors using computer specific software. Another use of matched sets is to reduce the overall purchasing costs; when several capacitors are used in parallel, a given tight tolerance can still be obtained on the final assembly while using wider tolerance single chips.

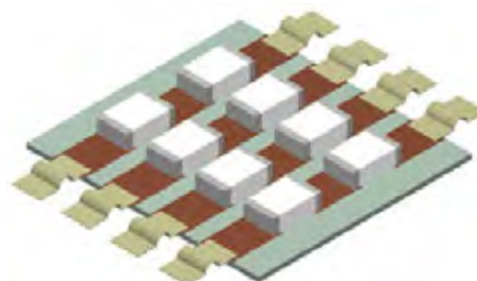

III. GUIDELINES

Several factors have to be considered when designing high RF power applications and these factors are in fact all linked to the overall thermal management of the entire design.

III.1. Influence of ESR

The capacitors with ultra-low ESR provide a higher maximum current for power dissipation limited operating conditions – as $I_p = f\left(\frac{1}{ESR}\right)$ – allowing the overall design to handle more RF power. Of course, the dissipation factor characteristics also have to be compliant with this increased power.

In the example below, a 300W CW module at 350MHz is pushed above its limits to emphasize the importance of ESR.



In the same conditions, several capacitor types are monitored as DUT and the results are shown below:



General Information

III.2. Influence of Magnetism

The choice of Power Capacitor Solutions in high magnetic field environment is critical. EXXELIA has conducted several tests with both his final customers and external laboratories to extend his knowledge and develop better solutions. These solutions play a major role in reducing the overall system temperature. Please contact EXXELIA for any further information.

III.3. Generic Comments

The main guidelines to lower the overall thermal load on the design are listed hereafter:

The thermal conductivity of all devices involved as well as board trace dimensions and material thickness have to be evaluated;

The main part of the heat transfer is achieved by thermal conduction. Actually, around 80% of the power is dissipated by conduction, 15% by convection and 5% by radiation. Therefore, the greater part of heat transfer is through the terminations of the capacitors. In order to further improve the thermal path of a porcelain capacitor, one should use leads such as non-magnetic micro-strip silver ribbons. The leads also offer another advantage: when the thermal expansion coefficients of the capacitor and the board are mismatched, they may act as a mechanical strain relief;

To avoid reducing drastically the thermal conductivity at some specific locations within the circuit, one should avoid reducing the width of the board trace and using wires;

Heat sinks and blown cool air will also help to reduce the additional sources of heat generated by passive components, FETs and active gain blocks;

Paschen's law defines the voltage rating for a given pressure. Therefore, depending on the operating conditions, the pressure parameter has to be considered (coating, voltage safety margin...);

Using Power Capacitor Solutions with parallel combinations will extend the RF power handling. For instance, N capacitors in parallel will led approximately to an ESR which is N-times lower than the one of a single capacitor, thus increasing the maximum current handling capability by a factor of \sqrt{N} .

IV. CONCLUSION

This article has described the major factors to consider while designing a Power Capacitor Solution for high RF power applications. The benefits of using Power Capacitor Solutions are numerous: high RF power, enhanced reliability with pre-tests, ultra-low ESR, reduced costs with matched sets, availability of specific capacitance values and tolerances, fewer assembly stages, customized styles...

To ensure the highest level of reliability in high RF power designs, factors such as heat transfer, maximum voltage and current ratings, thermal characteristics of the circuit devices and ways to remove the heat should be taken into account.

EXXELIA designs Application-Specific Solutions based on parallel and series combinations of designer-acclaimed capacitors. Customer requirements are addressed by computer matching sets, a wide range of mechanical configurations, a protective coating and adapted ribbons or wires which have enabled EXXELIA to extend overall performance while decreasing the total cost of ownership.

EXXELIA - by knowing the ESR and power dissipation of its capacitors at the application operating frequencies - helps the designers by simulating the thermal behavior of the assembly and proposing the optimum Power Capacitor Solution.

Ref

- [1] Thermal Conductivity wikipedia
- [2] Cours de thermique P.ROUX (2016)

POWER CAPACITOR ENDURANCE TESTING ULTRA-LOW ESR, HIGH RF POWER

I. FOREWORDS

I.1. Concept

Figure 1 shows the general concept. The setup contains a direct digital synthesizer (DDS) that generates an RF signal with a variable frequency. Its signal is amplified by a driver stage followed by a power amplifier stage. The gain of the PA stage is controlled by varying its supply voltage. For that purpose a variable power supply is provided. The directional coupler measures the forward and the reflected power. The latter is a value that describes the quality of the matching condition. The role of the matching network is to match the capacitor to a 50W load. The capacitor under test is mounted on a separate printed circuit board and is encapsulated by a small cabinet. This cabinet isolates the capacitor from the ambient temperature. A temperature sensor is integrated into the cabinet to measure the capacitors temperature.

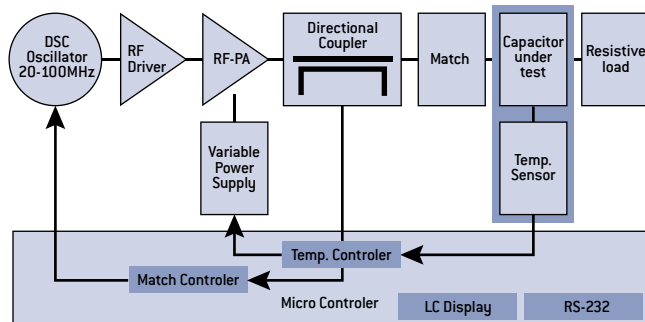

Figure 1

With a microcontroller, there are two control loops realized. The temperature of the capacitor is measured at the beginning of the 5 seconds off time with a temperature sensor. The sensor's signal is used to control the variable power supply which influences the power amplifiers gain and as a consequence, the output power or the current through the capacitor under test.

The ground plane improves the heat spread between the capacitors. This is further supported by a copper bar that is directly pressed on the ground plane of the PC board. On the front side of the copper bar, a NTC is mounted. Tests have shown that this heat coupling is very critical for the overall performance. The NTC is screwed directly and by that the heat coupling is both tight and reliable.

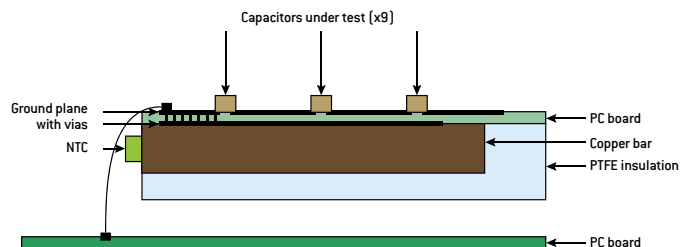

Figure 2

I.2. Test Cycle

The complete test cycle is shown in figure 3. The test starts with a tuning procedure at low power. As soon as the matching condition is achieved the RF power is set to the value that is necessary to heat the capacitors. During the ON time, the frequency is continuously adjusted to minimize the reflected power. After 5 seconds ON, the RF is switched off for the next 5 seconds. Then the RF is switched on again. Because the capacitors have cooled down during the OFF time, the test generator needs to re-tune.

General Information

The re-tune procedure takes 500ms. After that, the RF is ON for the next 5 seconds. That way a complete cycle takes 10 seconds.

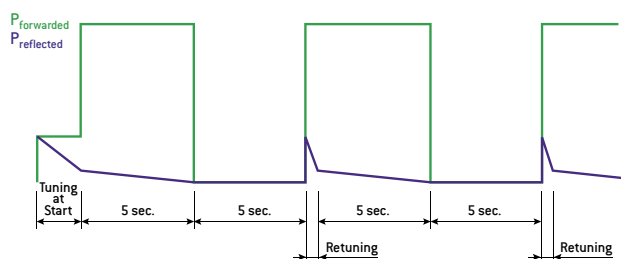

Figure 3

The following conditions have been used:

- HiQ multilayer ceramic capacitors operated at 27MHz;
- 2 complete test sets are done, one for B size (1111) and another for X size (2225);
- a complete test set represents 1 million cycles (4 months of continuous RF power).

I.3. Data Acquisition

The test generator measures continuously: the frequency, the forward power, the reflected power and the three temperatures. The test generator stores these values always at the end of the 5 seconds ON time. The remote computer gathers the data at least once each cycle and writes these records to a log file. Each file collects the record of one day and is automatically sent by email once a day.

II. RESULTS

All the tests have been performed by an external independent company named Barthel HF Technik located in Aachen, Germany.

II.1. HiQ Capacitors – B Size (1111) – Solderable Nickel Barrier

The CHB series RF/Microwave capacitors offer both extended operating temperatures up to 175°C and extended voltages up to 1500 VDC. These components are based on our well-known P100 HiQ dielectric, a low loss material, which is ESA and MIL qualified -ITAR free.

On May the 9th 2011, the test set was completed without any problem to report.

II.2. HiQ Capacitors – X Size (2225) – Non Magnetic Solderable Barrier

The CLX series High RF Current/Voltage capacitors offer both ultra stability over temperature and extended voltages up to 3 600 VDC. These components are based on our well-known NPO HiQ dielectric, a low loss and ultra stable material, which is MRcertified® and MIL qualified -ITAR free.

On November the 9th 2011, the test set was completed without any problem to report.



III. CONCLUSIONS

These tests have shown the reliability of Temex-Ceramics capacitors in operation. Each of the HiQ capacitors under test has been exposed during 4 months to their maximum RF power signal rating, heated up to 125°C continuously and without any failure or event to report.

This endurance test, along with the European Space Agency qualification (see ESA.pdf on our website), the regular life test performed on standard production lots (see Reliability_Data.pdf) and the MIL class R rating (see MIL.pdf) highlight, the high quality and reliability associated with EXXELIA capacitors.

IV. APPENDIX

The capacitance of the capacitor under test may vary during the temperature ramp up time. Additionally it may vary if there is a beginning of destruction process. If the frequency was kept constant, the RF power coupled into the capacitor under test will decrease. Hence the temperature control loop will increase the RF power.

This may lead to a situation where the temperature decreases when the RF power cannot be increased any more. In order to cope with this, there is a second control loop that varies the frequency in order to minimize the reflected power. So the RF power amplifier stage will always be able to deliver the necessary power to keep the temperature constant.

As PC board, a ceramic material from Rogers is used, the R04350 material. Comparing to the standard FR4 material the ceramic board has the following advantages: improved heat conductivity; improved heat resistance and improved electrical strength.

Due to the improved electrical strength, it was possible to have a ground plane on the bottom side of the board. The coupler bar rests on a PTFE insulation. It was meant to be a heat insulation. However, during pre-tests, it became apparent that the PTFE material spreads the heat more than expected. In order to improve the heat insulation towards ground and the ambient air, the complete setup is now surrounded by a layer of glass wool.



General Information

All these efforts led to the following results: the temperature difference between the RF on time and the RF off time is less than 10°C and a total RF power of approximately 35 Watts is sufficient to heat the capacitors to 125°C. The capacitors under test are soldered with a non lead solder, Sn95Ag4Cu1 which has an extended temperature range also. Figure 4 shows the test setup.

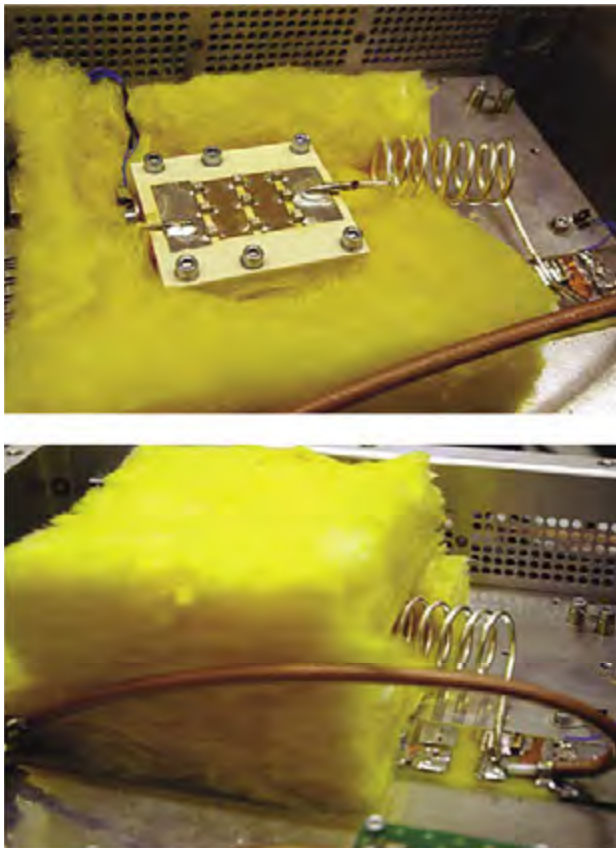

Figure 4

Both control loops are realized by a micro controller. Additionally, the micro controller provides an RS-232 interface to set some configuration values. A LC display shows warning messages also and some status information like temperature, RF power, etc.

The test generator works completely self sustained. It controls the temperature, RF power, frequency and all other parameters. The test generator takes also care that it remains itself within safe limits like maximum cool plate temperature, maximum forward power, maximum reflected power, frequency within a given bandwidth, etc. The test generator is connected to a remote computer.

NON MAGNETIC CAPACITORS ULTRA-LOW ESR, RF & MICROWAVE SYSTEMS

In today's world of medical systems, there is a trend in MRI equipment to increase the magnetic field – mostly from 1.5T to 3.0T. The higher signal strength obtained can then be translated into higher spatial resolution, enabling doctors to see finer details on the images. Whence the importance of non magnetic properties in the electronic components used in such systems.



At present, components with a significant magnetic response create parasitic black dots on the images, which may result in inaccurate or more difficult diagnosis – for instance the electrolytic capacitors aluminum or tantalum-based (paramagnetic). Not only this, but magnetic losses will overheat the system and reduce the reliability of the electronic components. Problems such as these - system temperature and component reliability - due to a significant magnetic response can moreover occur in any electronic equipment, though usually with a lower level of criticality.

To further improve reliability in such systems:

The electronic components used in MR systems, like the multilayer ceramic capacitors from EXXELIA, must have a very low magnetic response (diamagnetic);

A classification is needed for R&D engineers designing such systems, to quantify the magnetic response. This way, any component used in new developments – irrespective of its configuration, with wires or ribbons, etc. - would be guaranteed for MR applications;

Non magnetic components should also be proposed for non medical applications involving high RF power, so as to minimize losses and thereby improve the overall system performance.

The comprehensive magnetic study described below was conducted by the I.C.M.C.B. (the Bordeaux Institute of Chemistry of condensed materials), a laboratory under the aegis of the C.N.R.S. (French National Center for Scientific Research).



<http://www.cnrs.fr/index.html>

General Information

I. MAGNETIC FIELD NOTIONS

I.1. Magnetic Permeability

This is the degree of magnetization of a material that responds linearly to an applied magnetic field. The magnetic permeability (μ) of a given material is related to the permeability of vacuum (μ_0 , in Henries per meter) times its relative permeability (μ_R , no unit):

$$\mu = \mu_0 \times \mu_R$$

μ_0 is a universal constant, the magnetic constant, and has the value.

$$4\pi \times 10^{-7} \text{ H/m}$$

μ_R is related to the material under test.

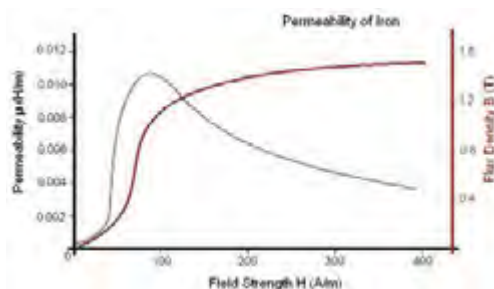

In vacuum, air, gases, ... μ_R is equal to 1. These materials do not modify magnetic field lines. There are three types of materials:

- Diamagnetic (silver, copper, gold, lead, ...) in which $\mu_R \leq 1$ and close to 1
- Paramagnetic (platinum, aluminum, magnesium, ...) where $\mu_R \geq 1$ and close to 1
- Ferromagnetic (nickel, cobalt, iron, ...) with $\mu_R \gg 1$

I.2. Paramagnetism

Paramagnetism is a form of magnetism which occurs only in the presence of an externally applied magnetic field. Paramagnetic materials are attracted to magnetic fields, and hence have a relative magnetic permeability μ_R greater than one - or, equivalently, positive magnetic susceptibility. However, unlike ferromagnets, which are also attracted to magnetic fields, paramagnets do not retain any magnetization in the absence of an externally applied magnetic field.

I.3. Diamagnetism

Diamagnetism is a weak repulsion from a magnetic field. It is form of magnetism that is exhibited by a substance only in the presence of an externally applied magnetic field. All materials show a diamagnetic response in an applied magnetic field but for materials which show some other form of magnetism (such as ferromagnetism or paramagnetism), the diamagnetism is completely overpowered.



Substances which display only, or mostly, diamagnetic behavior are termed diamagnetic materials, or diamagnets. Materials referred to as diamagnetic are those which are usually considered by non-physicists as "non magnetic", and include water, DNA, most organic compounds such as petroleum and certain plastics, and many metals such as mercury, gold and bismuth.

I.4. Ferromagnetism

Ferromagnetism is defined as the phenomenon by which materials, such as iron, in an external magnetic field, become magnetized and remain so for a period after the material is no longer in the field.

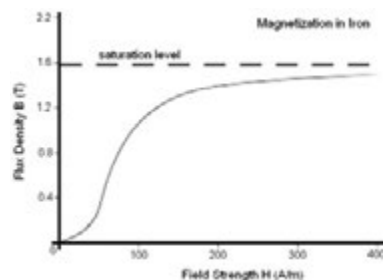

I.5. Magnetic Susceptibility

Magnetic susceptibility (X_v) is the degree of magnetization of a material in response to an applied magnetic field. If X_v is positive, then $(1+X_v) > 1$ and the material is said to be paramagnetic. In this case, the magnetic field is strengthened by the presence of the material. Conversely, if X_v is negative, then $(1+X_v) < 1$, and the material is termed diamagnetic. As a result, the magnetic field is weakened in the presence of the material.

Class	X_v dependant on B?	Dependent on temperature?	Hysteresis?	Example	X_v
Diamagnetic	No	No	No	Water	-9×10^{-6}
Paramagnetic	No	Yes	No	Aluminum	2.2×10^{-5}
Ferromagnetic	Yes	Yes	Yes	Iron	3000

I.6. Units

The International System of Units (abbreviated "SI" from the French "Système International d'unités") is the modern form of the metric system. It is the world's most widely used system of units, both in everyday commerce and in science. The older metric system included several base units. The SI was developed in 1960 from the old meter-kilogram-second (MKS) system, rather than the centimeter-gram-second (CGS) system, which, likewise, had a number of variants.

The SI introduced several newly named units. The SI is not static, but a living set of standards in which units are created and definitions are modified through international agreement as the technology of measurement progresses.

Parameter	CGS System	Correcting Factor	SI unit
Magnetic Induction B	G [gauss]	10^{-4}	T [tesla]
Applied Field H	Oe [oersted]	$10^3/4\pi$	A/m
Magnetization Mg	emu/erg/G	1	A.m ² /kg
Mass Susceptibility Xg	cm ³ /g	$4\pi \times 10^{-3}$	m ³ /kg
Permeability μ	-	$4\pi \times 10^{-7}$	H/m

NB: when a material is paramagnetic, the best way to describe it is in terms of magnetic susceptibility X_g . When the material is ferromagnetic, magnetization M_g is preferred. The following formula could be used:

$$M_g = X_g \times H$$

One should also note that:

$$X_v = X_g \cdot [\text{density}]$$

General Information

II. EXPERIMENTAL SETUP

II.1. Magnetometer

Measurements were taken using a Quantum Design magnetometer, model MPMS-5. The MPMS provides solutions for a unique class of sensitive magnetic measurements in key areas such as high-temperature superconductivity, biochemistry and magnetic recording media. This began developing significantly in 1988 with the discovery of a new class of superconducting materials. While the basic application has not changed greatly, its use has expanded to more than 530 installations worldwide.

The modular MPMS design integrates a SQUID detection system - Superconducting Quantum Interference Device, a precision temperature control unit residing in the bore of a high field superconducting magnet, and a sophisticated computer operating system:

- Maximum Sample Size: 9 mm;
- Field Uniformity: 0.01% over 4 cm;
- Temperature Range: 1.9-400 K;
- Sensitivity of 10^{-7} emu-CGS.

II.2. Superconducting Quantum Interference Device

The main components of a SQUID (see Fig. 1) magnetometer are: (a) a superconducting magnet; (b) a superconducting detection coil which is coupled inductively to the sample; (c) a SQUID connected to the detection coil; (d) a superconducting magnetic shield. A description of each one is given below:



Fig. 1

II.2.1. Superconducting Magnet

A superconducting magnet is a solenoid made of superconducting wires (see Fig. 2). The solenoid must be kept at liquid helium temperature in a liquid-helium medium. The uniform magnetic field is produced along the axial cylindrical bore of the coil. Superconducting solenoids that produce magnetic fields in the range 5-18 Tesla are now commercially available. A superconducting magnet requires an appropriate programmable bipolar power supply for operation.



Fig. 2

II.2.2. Superconducting Detection Coil

This is a single piece of superconducting wire, configured as a second-order gradiometer (see Fig. 3). This pick-up coil system is placed in the uniform magnetic field region of the solenoidal superconducting magnet.



Fig. 3

II.2.3. SQUID

High sensitivity is possible because this device responds to a fraction of the flux quantum. The SQUID device is usually a thin film that functions as an extremely sensitive current-to-voltage-converter. A measurement is taken in this equipment by moving the sample through the second-order gradiometer. Hence, the magnetic moment of the sample induces an electric current in the pick-up coil system. A change in the magnetic flux in these coils modifies the persistent current in the detection circuit. The current change in the detection coils then produces a variation in the SQUID output voltage proportional to the magnetic moment of the sample.

II.2.4. Superconducting Magnetic Shield

This is used to shield the SQUID sensor from the fluctuations of the ambient magnetic field in the magnetometer's location and from the large magnetic field produced by the superconducting magnet.

II.2.5. Applications

This kind of equipment can be used to measure: (a) the real and imaginary components of the AC magnetic susceptibility as a function of frequency, temperature, AC magnetic field amplitude and DC magnetic field value; (b) the DC magnetic moment as a function of temperature, DC magnetic field, and time.

II.3. Capsule Magnetization

The sample under testing has to be placed in a small capsule of 5-mm diameter and 8-mm length. Submitted to a magnetic field, the sample acquires a magnetization. The capsule is then placed in a 6-cm tube which results in a field strength variation. This is then measured in the SQUID and converted into a magnetization (uem-CGS unit in our case). Thin paper is used to secure the sample in place inside the capsule. Measurements were made with a controlled temperature (298.0 ± 0.1 K) and in the 0 to 3.5 T range ($35'000$ Oe) as the magnetic field declined.

General Information

The first step before measuring any sample is to define the magnetization of the sample carrier, i.e. the capsule with some thin paper. Then, as the samples are measured, all the magnetization values are corrected using the pattern below:

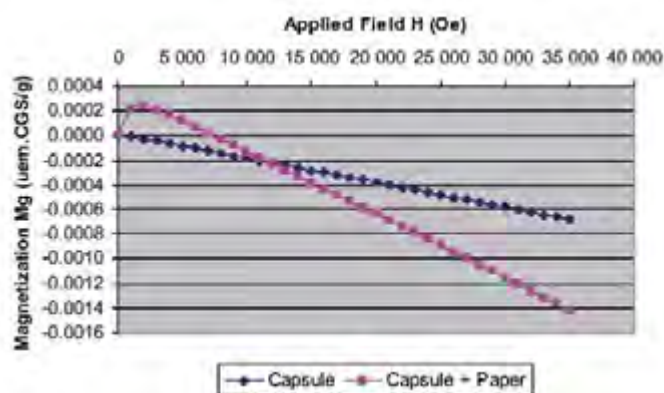

The signal from the capsule is diamagnetic and very weak. The signal from the capsule +the paper assembly is more complex to determine, combining a strong diamagnetic signal and a small ferromagnetic contribution (impurities in the paper material).

A constant corrective factor was then applied on all the measurements as a first approximation.

III. LABORATORY MEASUREMENTS

The aim of this study is to define a range of magnetization values within which electronic components may be considered as non-magnetic and suitable for critical medical and high RF power applications.

Several components were therefore tested to define a spectrum as wide as possible. For instance, if we consider the high-Q multilayer ceramic capacitor: we started with the chip alone, without even its terminations, adding a new variable - such as copper or silver-palladium or nickel terminations, silver ribbons and finally laser marking - at each subsequent stage. Using this protocol, it is easy to see the effect of each variable on the final magnetization.

The magnetization in the charts below is given per gram. Each sample - or set of samples - is then weighed before the test run. The following designs were tested:

Designation	Number of Samples	Weight (mg)	Batch Number
501 CHB 4R7	3	155.1	C706527
501 CHB 4R7 BC	1	61.5	C649212
501 CHB 4R7 BC1L	1	133.6	C649212-0
501 CHB 4R7 BAL	1	57.5	52196
501 CHB 4R7 BS	1	61.2	C645208-2
silver leads type 1	2	55.4	CK/6297
silver leads type 2	2	57.2	CK/BC/2205
AT9401	1	58.6	OT0041006P
AT9402	1	60.8	OT0111206P
AT9410	2	194.0	OT0020806P

The descriptions of the samples used are as follows:

- 501 CHB 4R7 B size (1111) capacitor, 4.7pF, no termination
- 501 CHB 4R7 BC B size (1111) capacitor, 4.7pF, copper termination
- 501 CHB 4R7 BC1L B size (1111) capacitor, 4.7pF, copper termination, leads
- 501 CHB 4R7 BAL B size (1111) capacitor, 4.7pF, silver-palladium termination
- 501 CHB 4R7 BS B size (1111) capacitor, 4.7pF, nickel termination
- silver leads type 1 silver leads used with B size capacitors
- silver leads type 2 silver leads currently undergoing qualification
- AT940 ceramic trimmer capacitor, 0.6 to 2.0pF, gold termination
- AT9402 ceramic trimmer capacitor, 1.0 to 5.0pF, gold termination
- AT9410 ceramic trimmer capacitor, 4.0 to 18pF, gold termination

III.1. DUT: 501 CHB 4R7

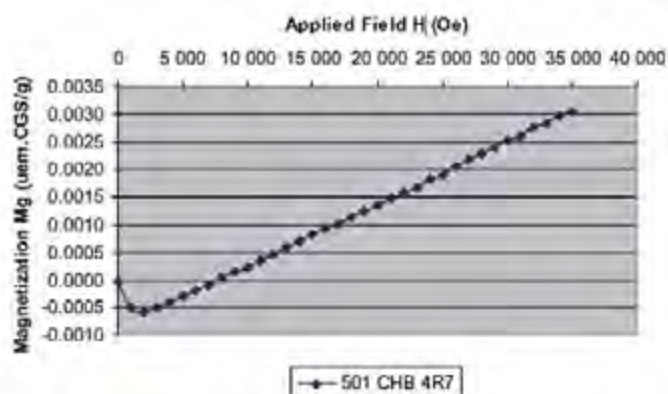

This sample shows a slightly paramagnetic behavior. Its magnetic susceptibility X_g is around 10^{-7} uem.CGS/g which is a very low value.

III.2. DUT: 501 CHB 4R7 BC

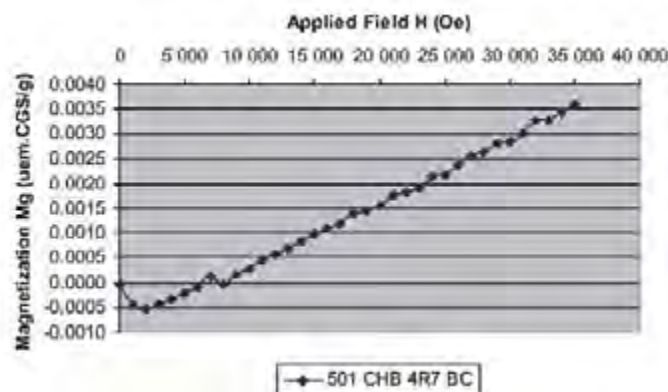

This sample has a slightly paramagnetic behavior. Its magnetic susceptibility X_g is around 10^{-7} uem.CGS/g which is a very low value.

General Information

III.3. DUT: 501 CHB 4R7 BS

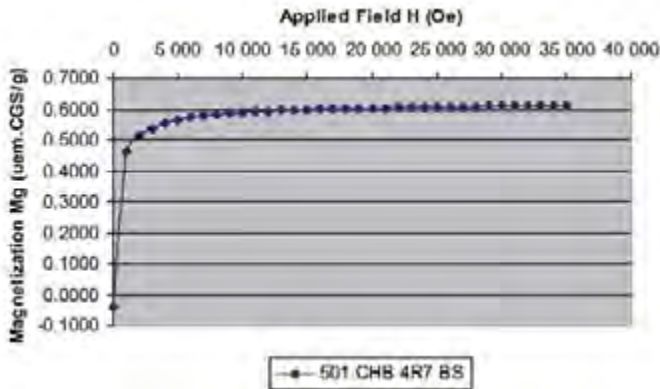

This sample exhibits a very strong magnetic behavior with a magnetization around 0.6 uem.CGS/g.

III.5. DUT: 501 CHB 4R7 BC1L

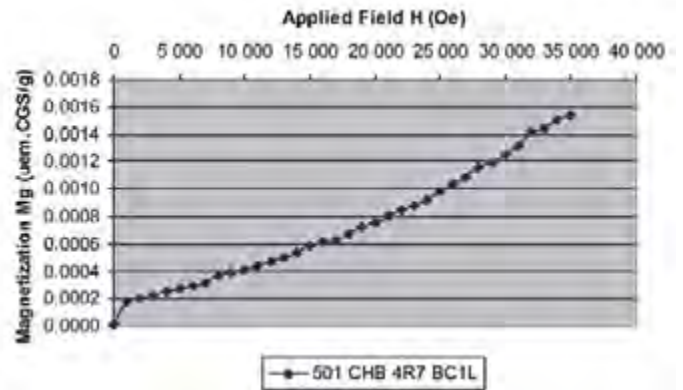

This sample shows a paramagnetic behavior with a magnetic susceptibility X_g around 0.4×10^{-7} uem.CGS/g.

III.4. DUT: 501 CHB 4R7 BAL

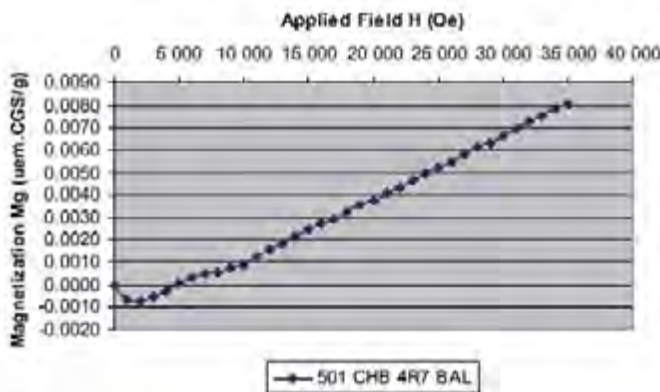

This sample has paramagnetic behavior with a magnetic susceptibility X_g around 2.3×10^{-7} uem.CGS/g.

III.6. DUT: SILVER LEADS

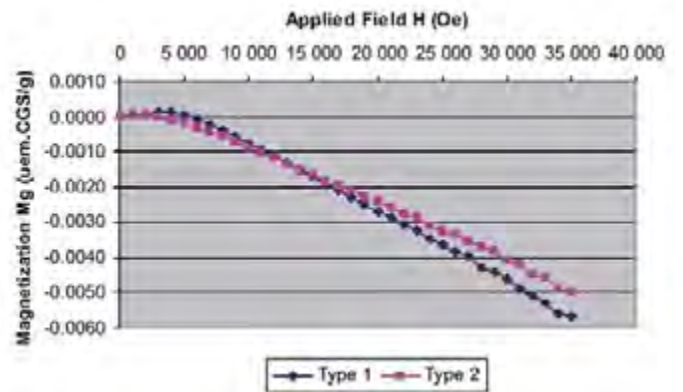

These two samples exhibit very similar diamagnetic behavior. The magnetic susceptibility X_g is in both cases around -1.6×10^{-7} uem.CGS/g.

III.7. DUT: AT9401

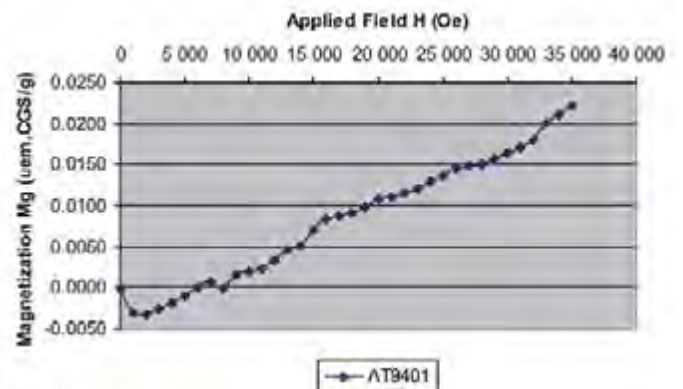

This sample has a paramagnetic behavior with a relatively high magnetic susceptibility X_g around 7.1×10^{-7} uem.CGS/g.

General Information

III.8. DUT: AT9402

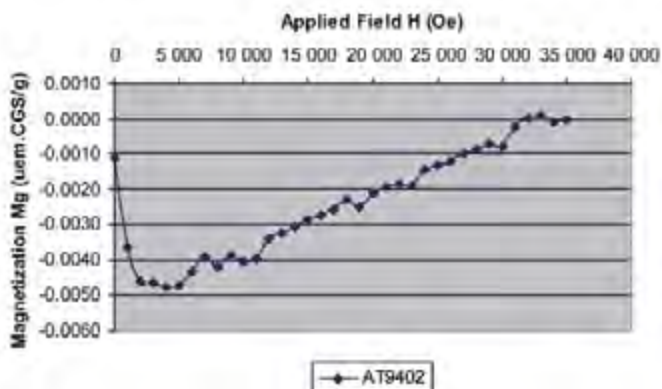

This sample has a paramagnetic behavior with a relatively low magnetic susceptibility X_g around 10^{-7} uem.CGS/g.

III.9. DUT: AT9410

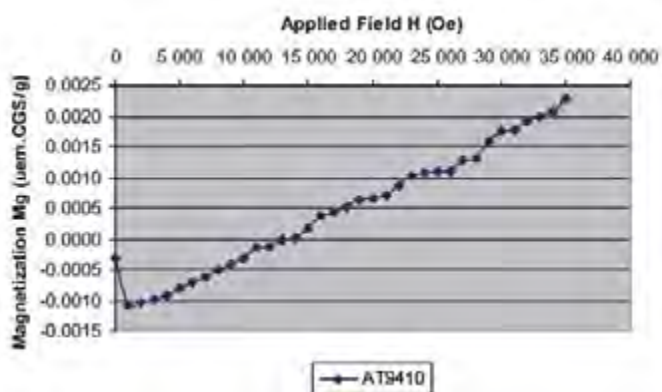

This sample has a paramagnetic behavior with a relatively low magnetic susceptibility X_g around 10^{-7} uem.CGS/g.

IV. ANALYSIS

IV.1. Influence Of Leads

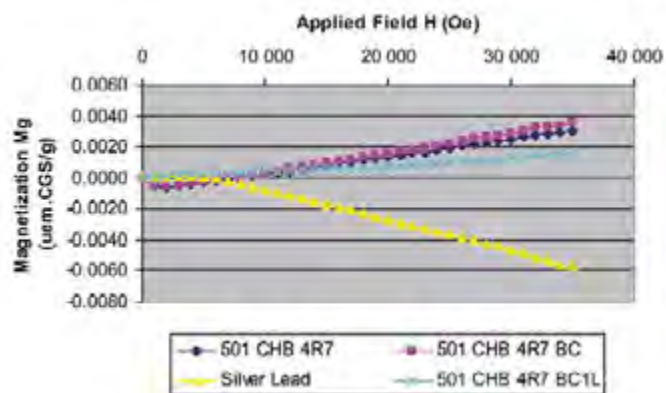

From the above chart, the following points may be deduced:

The copper termination slightly increases the magnetic susceptibility of the chip but the total value remains very low and the paramagnetic behavior is suitable for non-magnetic applications;

As the ribbon shows strong paramagnetic behavior, the assembly made with the capacitor and the leads has an even lower magnetic susceptibility than the chip alone. This means that for a very strong requirement for non-magnetic criteria, the assembly made of capacitor and leads is better than the capacitor itself;

In theory, it should be possible to decrease the magnetic susceptibility of the assembly – capacitor and leads – still further to reach a nearly a nil value, by using thicker or longer silver leads. These would also improve the heat transfer and therefore allow higher working power.

General Information

IV.2. INFLUENCE OF TERMINATIONS

IV.2.1. Copper Versus Nickel Terminations

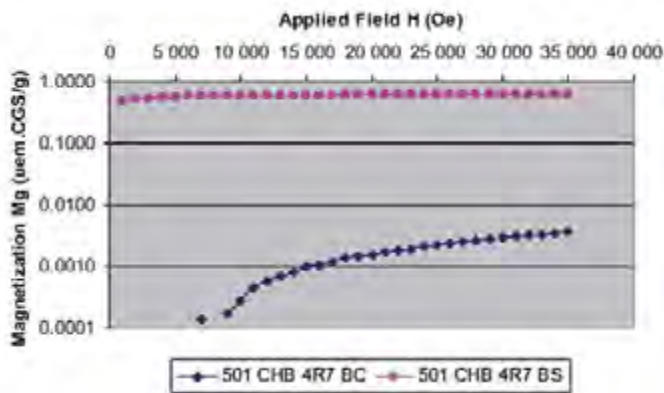

From the above chart, the following points may be deduced:

We are comparing here a magnetic termination – nickel barrier one – and a non-magnetic termination – copper barrier one. Naturally, the nickel termination cannot be used for non-magnetic applications but it enables us to define a limit above which a termination should not be classified as non-magnetic;

As we are using a logarithmic axis, the best magnetization value to consider for this limit seems to be around 0.10 uem.CGS/g;

Both copper and silver-palladium terminations are below this theoretical limit of 0.10 uem.CGS/g and can therefore be considered as non-magnetic.

VI.2.2. Copper Versus Silver-Palladium Terminations

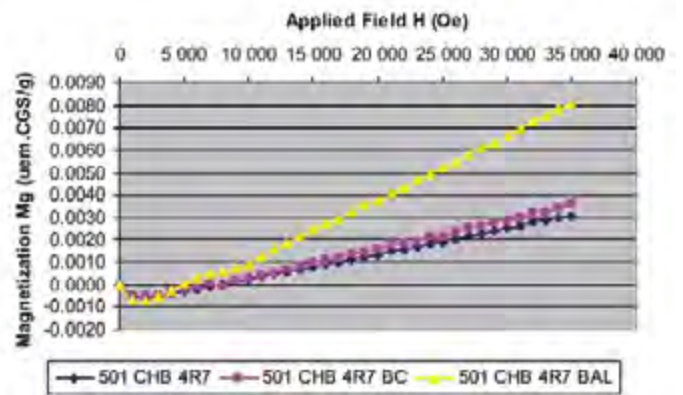

From the above chart, the following points may be deduced:

The copper or silver-palladium terminations slightly increase the magnetic susceptibility of the chip but the total value remains very low and the paramagnetic behavior is suitable for non-magnetic applications;

The capacitor with silver-palladium terminations exhibits a magnetic susceptibility around three times higher than that of the capacitor with copper terminations. This means that for a very strong requirement for non-magnetic criteria, the copper terminations are better than the silver-palladium ones;

Both these terminations are suitable for non-magnetic applications as their magnetization is always below 0.10 uem.CGS/g.

IV.3. Trimmer Capacitors

On the basis of the 0.10 uem.CGS/g limit previously discussed, the behavior of ceramic trimmer capacitors could also be studied.

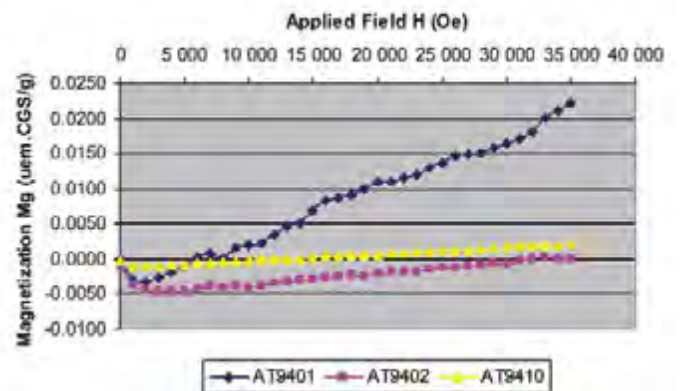

From the above chart, the following points may be deduced:

These three ceramic trimmer capacitors are all suitable for non-magnetic applications, as their magnetization is always below 0.10 uem.CGS/g;

The AT9402 and AT9410 exhibit very good paramagnetic behavior and are therefore recommended for applications with a very strong non-magnetic requirement.

General Information

IV.4. PERMEABILITY

IV.4.1. Definitions

Some engineers prefer to define the magnetic behavior of a component using its permeability. Therefore, an empirical limit above which components are not suitable for non-magnetic applications seems to have been set at 1.0005 for the relative permeability μ_r .

This relative permeability could be deduced from our measurements using the following method:

Mass susceptibility X_g is given by the slope of the $M_g = f(H)$ curve

Volume susceptibility X_v is equal to: $X_g \times [\text{density}]$

Relative permeability is finally equal to: $1 + X_v$

IV.4.2. Examples

Let's consider the 501 CHB 4R7 BC we measured previously. From the experimental curve, we find a mass susceptibility X_g of 10^{-7} uem.CGS. As our components exhibit a density around 4, the volume susceptibility X_v is then equal to 4×10^{-7} uem.CGS. Finally, permeability μ_r is then equal to 1.0000004, which is well below the theoretical limit of 1.0005

Even if there is no mass susceptibility X_g for a magnetic component – except at very low fields but customer's applications are far above this range – we can run the exercise for the 501 CHB 4R7 BS studied previously. From the first two dots on the experimental curve, we find a mass susceptibility X_g of 0.5×10^{-3} uem.CGS. As our components exhibit a density around 4, the volume susceptibility X_v is then equal to 2×10^{-3} uem.CGS. Finally, permeability μ_r is then equal to 1.002, which is, as expected, well above the theoretical limit of 1.0005

V. CONCLUSIONS

C.N.R.S. and EXXELIA have conducted a comprehensive study of the non-magnetic behavior of electronic components. This document describes the results of that study on multilayer porcelain capacitors and ceramic trimmer capacitors.

It flags up the following points:

The measurements made on magnetic and non-magnetic components enable us to define a first limit for magnetization of around 0.10 uem.CGS/g above which components can no longer be rated as non-magnetic;

All our non-magnetic components – both porcelain capacitors and ceramic trimmer capacitors – are below this limit and are therefore Magnetism-free Rated. To enable R&D engineers to quickly distinguish in the EXXELIA portfolio which components are guaranteed for non-magnetic applications, the following specific logo will be added to specific series in our Application datasheets:



The above logo certifies that a specific electronic component is Magnetism-free Rated;

Concerning non-magnetic applications - mainly medical systems -, the best solution to obtain a very low magnetization ceramic capacitor is to use one with copper terminations;

The silver leads, made from pure silver, are completely non-magnetic;

Concerning standard applications like telecom, industrial, military or space systems, as any system induces a magnetic field, the use of non-magnetic components would rule out magnetic losses and therefore improve the overall performances, particularly in switch-mode operations.



DESCRIPTION

- EIA 0402 Case size
- Capacitance: 100nF
- Low insertion loss up to 40 GHz
- RoHS Compliant

APPLICATIONS

- Optoelectronics / High-speed data
- Broadband test equipment & applications
- Broadband microwave / millimeter wave amplifiers and oscillators

CIRCUIT APPLICATIONS

- DC Blocking, Coupling, Bypassing

ELECTRICAL AND ENVIRONMENTAL SPECIFICATIONS

Electrical specifications

Parameter	Value
Capacitance	100nF
Tolerances	K ($\pm 10\%$)
Working voltage (WV_{DC})	16V
Temperature coefficient	X7R
Insulation Resistance	$10^9 \Omega$ min.
Insertion Loss @ 10Ghz (typical)	<0.3 dB
Insertion Loss @ 20Ghz (typical)	<0.5 dB
Insertion Loss @ 40Ghz (typical)	<1.2 dB
DF	$\leq 5\%$
Dielectric Withstanding (test voltage applied for 5 seconds)	1.5 WV_{DC}

Mechanical specification

Parameter	Value	Comment
Case size	L	0402
Termination type		
	Code	
Standard (Tin-plated Nickel)	S	
Packaging		
	Code	
Tape and reel	E	

Environmental specifications

Parameter	Value
Life Test	1000 hours, +125°C at 1.5 WV_{DC}
Moisture Resistance	240 hours, 85% relative humidity at 85°C (ESA/SCC n°3009)

HOW TO ORDER

160	XB	L	104	K	S	E
Voltage code	Dielectric	Case size	Capacitance code	Tolerance code	Termination code	Tape and reel
160 = 16V	X7R	L = 0402	104 = 100nF	K = $\pm 10\%$	S = Standard: tin-plated nickel	E = horizontal orientation

OUTLINE DIMENSIONS in inches (mm)

Size		0402
Dimensions inches (mm)	L	0.039 ± 0.008 (1 ± 0.2)
	W	0.236 ± 0.004 (0.6 ± 0.1)
	T	0.039 max. / 0.033 typical (1 max. / 0.85 typical)
	a	0.010 ± 0.006 (0.25 ± 0.15)

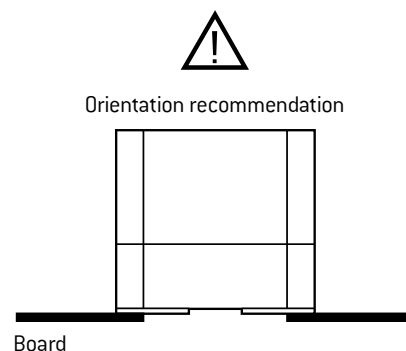
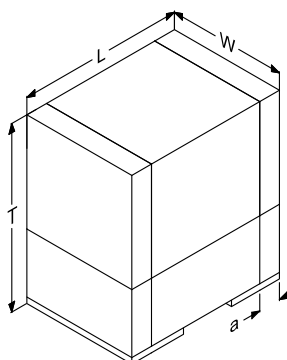

PERFORMANCE CHARACTERISTICS

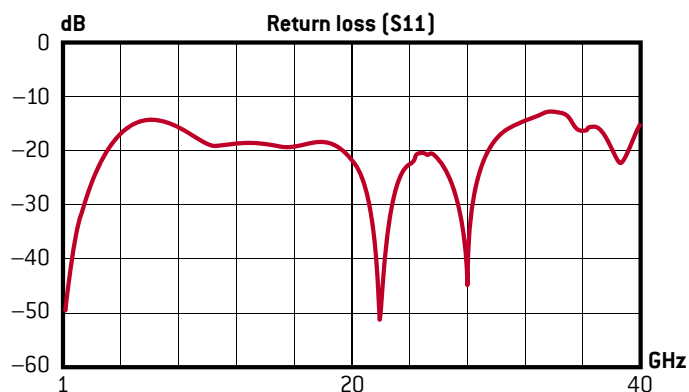

Typical responses of S11 and S21 Measurements on a PTFE 50 Ohm substrate

UBL Series

Ultra-Broadband Capacitors



DESCRIPTION

- EIA 0402 Case size
- Capacitance: 100nF
- Low insertion loss up to 40 GHz
- RoHS Compliant

APPLICATIONS

- Optoelectronics / High-speed data
- Broadband test equipment & applications
- Broadband microwave / millimeter wave amplifiers and oscillators

CIRCUIT APPLICATIONS

- DC Blocking, Coupling, Bypassing

ELECTRICAL AND ENVIRONMENTAL SPECIFICATIONS

Electrical specifications	
Parameter	Value
Capacitance	100nF
Tolerances	K ($\pm 10\%$)
Working voltage (WV_{DC})	16V
Temperature coefficient	X7R
Insulation Resistance	$10^9 \Omega$ min.
Insertion Loss @ 10Ghz (typical)	<0.5 dB
Insertion Loss @ 20Ghz (typical)	<1.2 dB
Insertion Loss @ 40Ghz (typical)	<1.5 dB
DF	$\leq 5\%$
Dielectric Withstanding (test voltage applied for 5 seconds)	$2 WV_{DC}$

Mechanical specification		
Parameter	Value	Comment
Case size	L	0402
Termination type		
	Code	
Standard (Tin-plated Nickel)	S	
Packaging		
	Code	Quantity
Parts per Reel	E	10 000

Environmental specifications	
Parameter	Value
Life Test	1000 hours, $+125^\circ\text{C}$ at $1.5 WV_{DC}$
Moisture Resistance	240 hours, 85% relative humidity at 85°C (ESA/SCC n°3009)

HOW TO ORDER

160	UB	L	104	K	S	E
Voltage code	Dielectric	Case size	Capacitance code	Tolerance code	Termination code	Tape and reel
160 = 16V	X7R	L = 0402	104 = 100nF	K = $\pm 10\%$	S = Standard: tin-plated nickel	E = horizontal orientation

OUTLINE DIMENSIONS in inches (mm)

Size	0402	
Dimensions inches (mm)	L	0.039 ± 0.004 (1 ± 0.1)
	W	0.197 ± 0.004 (0.5 ± 0.1)
	T	0.236 max. (0.6 max.)
	a	0.010 ± 0.004 (0.25 ± 0.1)

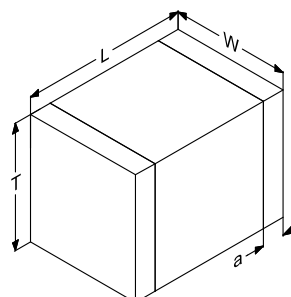

PERFORMANCE CHARACTERISTICS

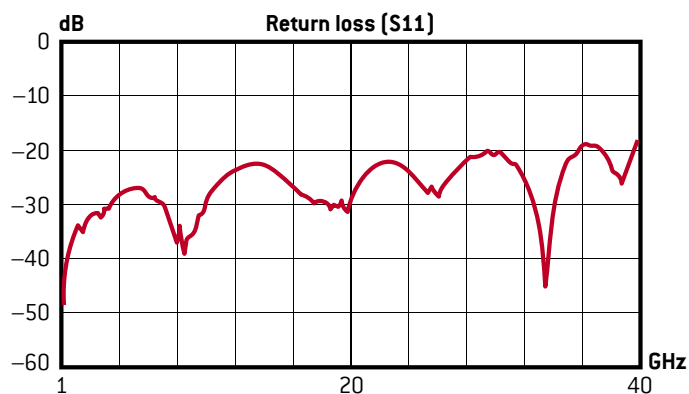
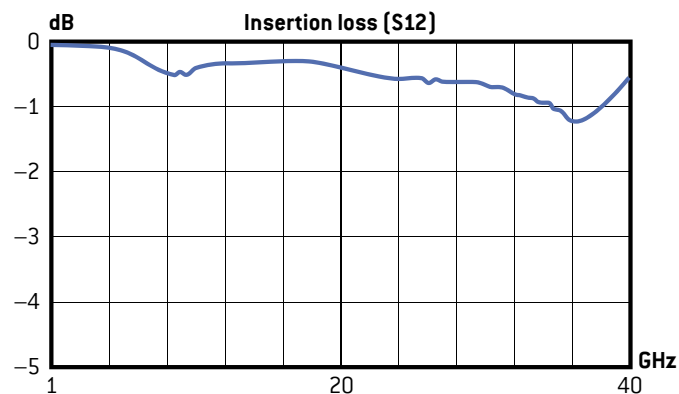

Typical responses of S11 and S21 Measurements on a PTFE 50 Ohm substrate

UBZ Series

Ultra-Broadband Capacitors



DESCRIPTION

- EIA 0201 Case size
- Capacitance: 100nF
- Low insertion loss up to 40 GHz
- RoHS Compliant

APPLICATIONS

- Optoelectronics / High-speed data
- Broadband test equipment & applications
- Broadband microwave / millimeter wave amplifiers and oscillators

CIRCUIT APPLICATIONS

- DC Blocking, Coupling, Bypassing

ELECTRICAL AND ENVIRONMENTAL SPECIFICATIONS

Electrical specifications	
Parameter	Value
Capacitance	100nF
Tolerances	K ($\pm 10\%$)
Working voltage (WV_{DC})	10V
Temperature coefficient	X5R up to 85°C X6T up to 105°C
Temperature coefficient for HT	X7S up to 125°C
Insulation Resistance	$10^9 \Omega$ min.
Insertion Loss @ 10Ghz (typical)	<0.5 dB
Insertion Loss @ 28Ghz (typical)	<1 dB
DF	$\leq 15\%$
Dielectric Withstanding (test voltage applied for 5 seconds)	2 WV_{DC}

Mechanical specification		
Parameter	Value	Comment
Case size	Z	0201
Termination type		
	Code	
Standard (Tin-plated Nickel)	S	
Packaging		
	Code	Quantity
Parts per Reel	E	15 000

Environmental specifications	
Parameter	Value
Life Test	1000 hours, +105°C at 1 WV_{DC} for "standard" version 1000 hours, +125°C at 1 WV_{DC} for "HT" version
Moisture Resistance	240 hours, 85% relative humidity at 85°C (ESA/SCC n°3009)

HOW TO ORDER

100	UB	Z	104	K	S	E	HT
Voltage code	Dielectric	Case size	Capacitance code	Tolerance code	Termination code	Tape and reel	Temperature
100 = 10V	X5R X6T X7S (HT)	Z = 0201	104 = 100nF	K = $\pm 10\%$	S = Standard: tin-plated nickel	E = horizontal orientation	HT = High temp. (125°C) – = Standard (85°C/105°C)

OUTLINE DIMENSIONS in inches (mm)

Size	0201	
Dimensions inches (mm)	L	0.024 ± 0.002 (0.6 ± 0.04)
	W	0.012 ± 0.002 (0.3 ± 0.04)
	T	0.014 max. (0.35 max.)
	a	0.006 ± 0.002 (0.15 ± 0.06)

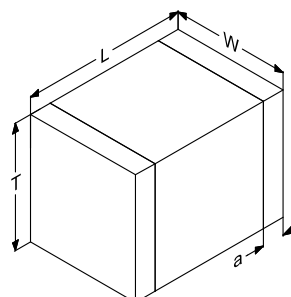

PERFORMANCE CHARACTERISTICS

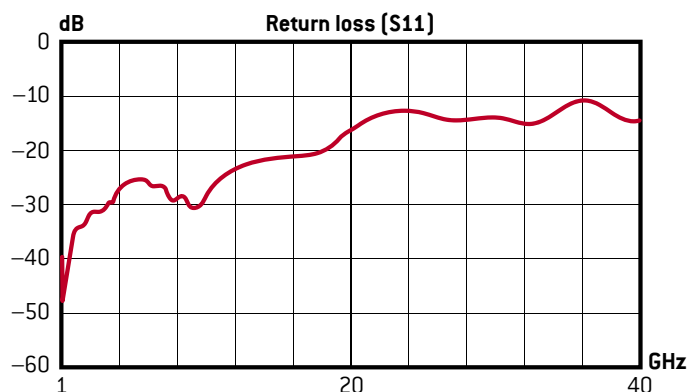

Typical responses of S11 and S21 Measurements on a PTFE 50 Ohm substrate

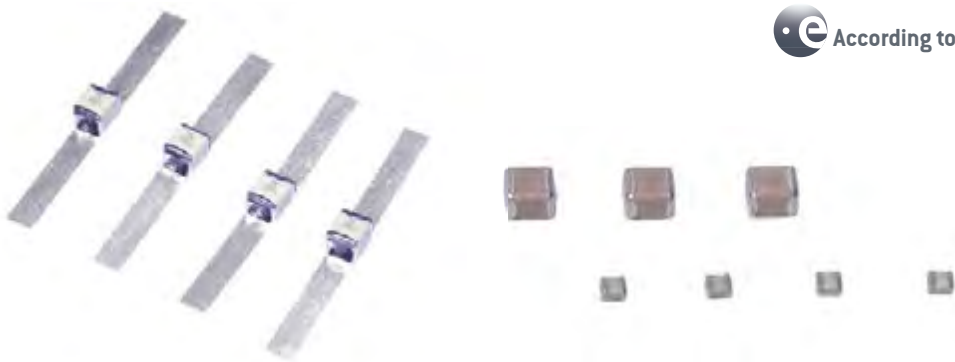

FEATURES

- Low ESR, Ultra High-Q, High Self-Resonant Frequencies
- RF & Microwave capacitors
- Voltage range: 50V - 1,500V
- Capacitance range: 0.1pF - 1,000pF
- Operating temperature up to 125°C*
- Porcelain Capacitors P100
- Laser Marked (optional)
- RoHS compliant

APPLICATIONS

- Cellular Base Station Amplifiers
- Industrial
- Medical (MRI)
- Scientific

CIRCUIT APPLICATIONS

- DC to RF Conversion
- Matching Networks
- Tuning, Coupling and DC Blocking

PHYSICAL CHARACTERISTICS

- Chip capacitors for surface mounting with copper (non magnetic) or nickel barrier and tinning
- Ribbon leads for surface mounting

HOW TO ORDER

152	CH	B	100	J	S	1	L	E	-RoHS
Voltage code	Dielectric	Size code	Capacitance code	Tolerance code	Termination code	Ribbon code	Marking code	Tape and reel	
500 = 50V 101 = 100V 201 = 200V 251 = 250V 301 = 300V 501 = 500V 601 = 600V 102 = 1,000V 152 = 1,500V Please refer to voltage given in capacitance range chart	CH = (100±30) ppm/°C	A = 0505 B = 1111	Please refer to capacitance code given in capacitance range chart	A = ±0.05pF B = ±0.1pF C = ±0.25pF D = ±0.5pF F = ±1% G = ±2% J = ±5% K = ±10% See note 1	S = Standard: tin-plated nickel C = Non-magnetic: tin-plated copper See note 2	-: no lead or ribbon <u>Available on size 1111:</u> 1 = Micro-strip ribbons 6 = Radial leads 0.1pF (0R1) non available with these terminations. See note 3	-: no marking L = laser marking	-: no tape and reel E = horizontal orientation X = verticale orientation CHA: 3,000 components per reel CHB: 1,000 components per reel	The RoHS tag is not part of the reference Tag added at the end of P/N for information

Note 1: For capacitance values less than 10pF, tolerances B, C and D available. Tolerance code A available for: A case for capacitance values of 0.1pF - 4.7pF. B case for capacitance values of 0.1pF - 3.3pF. For capacitance values of 10pF or higher, tolerances F, G, J and K available.

Note 2: All terminations are backward compatible and lead-free. The non-magnetic terminations are all Magnetism-free Rated.

Note 3: When coding ribbons for the description of the part, the termination has to be mentioned for MR certified types to ensure that only non-magnetic materials are used.

Note 4: Ribbon lead styles capacitors are not available in Tape and Reel.

Examples: 501 CHB 470 J1L any termination material could be used. 501 CHB 470 JC1L only non-magnetic termination materials could be used. Please consult us for specific requirements.

ELECTRICAL AND ENVIRONMENTAL SPECIFICATIONS

Electrical specifications	
Parameter	Value
Capacitance	0.1pF - 1,000pF
Tolerances	A, B, C, D below 10pF F, G, J, K above 10pF
Working voltage (WV _{DC})	See capacitance range chart
Temperature coefficient	(100 ± 30) ppm/°C, -55°C to +125°C
Insulation Resistance	10 ⁶ MΩ min.
Dielectric Withstanding (test voltage applied for 5 seconds)	2.5 x WV _{DC} for WV _{DC} ≤ 500V 1.8 x WV _{DC} for extended range values ≥ 820pF 1.5 x WV _{DC} for WV _{DC} > 500V
Aging	none
Piezo Effect	none

Environmental specifications	
Parameter	Value
Life Test	2,000 hours, +125°C at 2 x WV _{DC} And CHB : 1,000 hours, +175°C at 1 x WV _{DC}
Moisture Resistance Test 1	240 hours, 85% relative humidity at 85°C (ESA/SCC n°3009)
Moisture Resistance Test 2	56 days, 93% relative humidity at 40°C 0V, 5V, WV _{DC}

Classic HiQ

CH Series

TYPICAL PERFORMANCE DATA CHA (0505 SIZE):
S-Parameters available with ABC software.

ESR VERSUS FREQUENCY

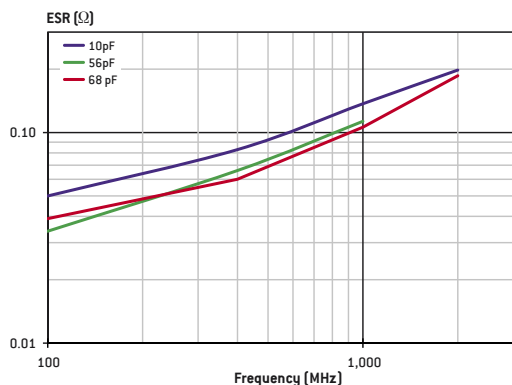

TYPICAL PERFORMANCE DATA CHB (SIZE 1111):
S-Parameters available with ABC software.

ESR VERSUS FREQUENCY

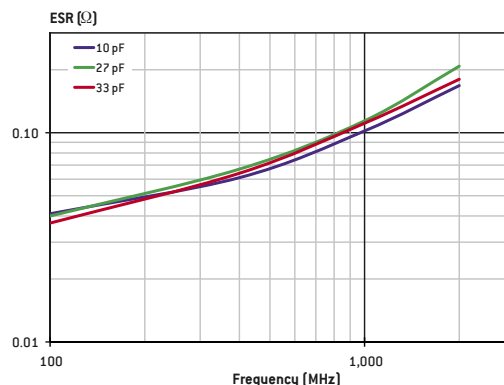

CURRENT RATING VERSUS CAPACITANCE

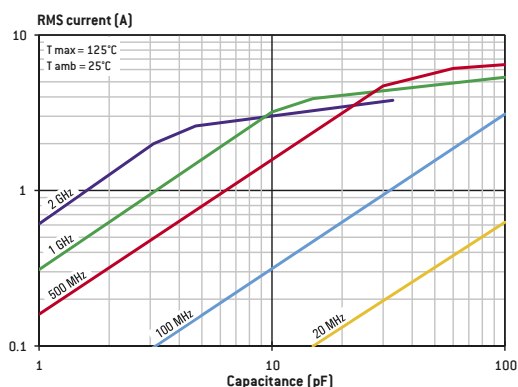

CURRENT RATING VERSUS CAPACITANCE

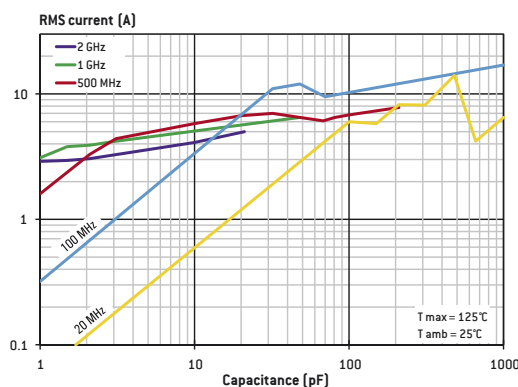

Q FACTOR VERSUS FREQUENCY

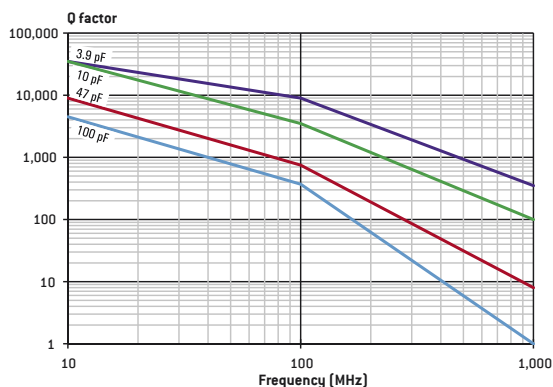

Q FACTOR VERSUS FREQUENCY

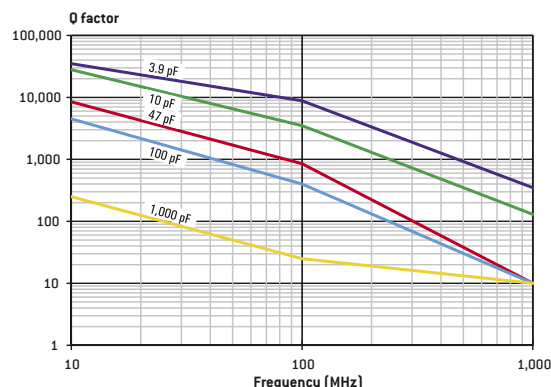

SERIES RESONANCE FREQUENCY VERSUS CAPACITANCE

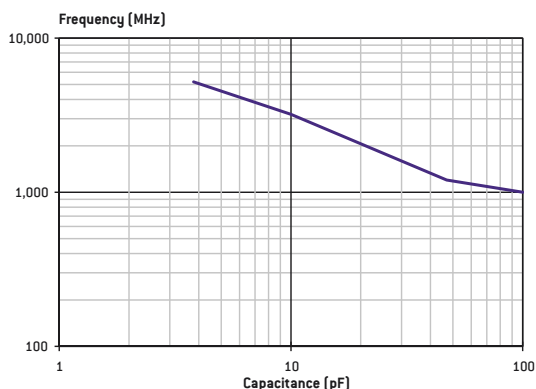

SERIES RESONANCE FREQUENCY VERSUS CAPACITANCE

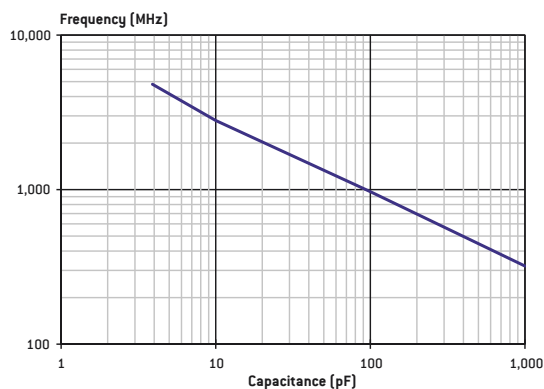

DIMENSIONS in inches (mm)

Chips

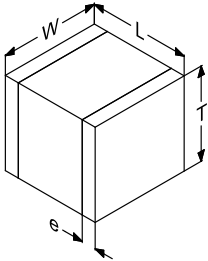

Micro-strip ribbon leads (Type 1)

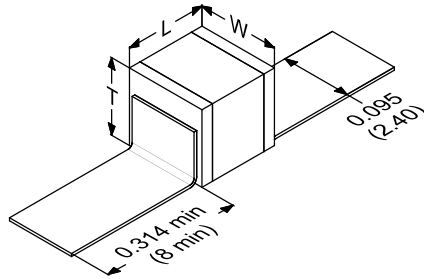

Radial leads (Type 6)

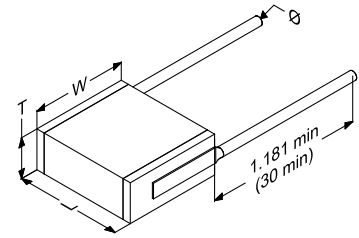

STANDARD RATINGS

Size		0505	1111	
Size code		A	B	
Dimensions inches (mm)	L	0.055 ± 0.01 [1.4 ± 0.25]	0.11 ± 0.016 [2.8 ± 0.4]	
	W	0.055 ± 0.01 [1.4 ± 0.25]	0.11 ± 0.016 [2.8 ± 0.4]	
	T	0.056 max [1.4 max]	0.103 max [2.6 max]	
	e	0.01 ± 0.006 [0.25 ± 0.15]	0.016 ± 0.01 [0.4 ± 0.25]	
Value (pF)	Cap. Code	Standard	Standard	Extended
0.1	OR1	250V	500V	1,500V
0.2	OR2			
0.3	OR3			
0.4	OR4			
0.5	OR5			
0.6	OR6			
0.7	OR7			
0.8	OR8			
0.9	OR9			
1.0	1R0			
1.1	1R1			
1.2	1R2			
1.3	1R3			
1.4	1R4			
1.5	1R5			
1.6	1R6			
1.7	1R7			
1.8	1R8			
1.9	1R9			
2.0	2R0			
2.1	2R1			
2.2	2R2			
2.4	2R4			
2.7	2R7			
3.0	3R0			
3.3	3R3			
3.6	3R6			
3.9	3R9			
4.3	4R3			
4.7	4R7			
5.1	5R1			
5.6	5R6			
6.2	6R2			
6.8	6R8			
7.5	7R5			
8.2	8R2			
9.1	9R1			
10	100			
11	110			
12	120			
13	130			
15	150			
16	160			
18	180			
20	200			
22	220			
24	240			
27	270			
30	300			
33	330			
36	360			
39	390			
43	430			
47	470			

Size		0505	1111				
Size code		A	B				
Dimensions inches (mm)	L	0.055 ± 0.01 [1.4 ± 0.25]	0.11 ± 0.016 [2.8 ± 0.4]				
	W	0.055 ± 0.01 [1.4 ± 0.25]	0.11 ± 0.016 [2.8 ± 0.4]				
	T	0.056 max [1.4 max]	0.103 max [2.6 max]				
	e	0.01 ± 0.006 [0.25 ± 0.15]	0.016 ± 0.01 [0.4 ± 0.25]				
Value (pF)	Cap. Code	Standard	Standard	Extended			
51	510	200V	500V	1,500V			
56	560						
62	620						
68	680						
75	750						
82	820						
91	910						
100	101						
110	111						
120	121						
130	131						
150	151						
160	161	300V	1,000V				
180	181						
200	201						
220	221						
240	241						
270	271						
300	301	200V	600V				
330	331						
360	361						
390	391						
430	431						
470	471						
510	511						
560	561				100V		
620	621						
680	681						
750	751						
820	821						
910	911	50V		300V			
1,000	102						

Special values, tolerances, higher WV_{DC} and matching available, please consult factory.

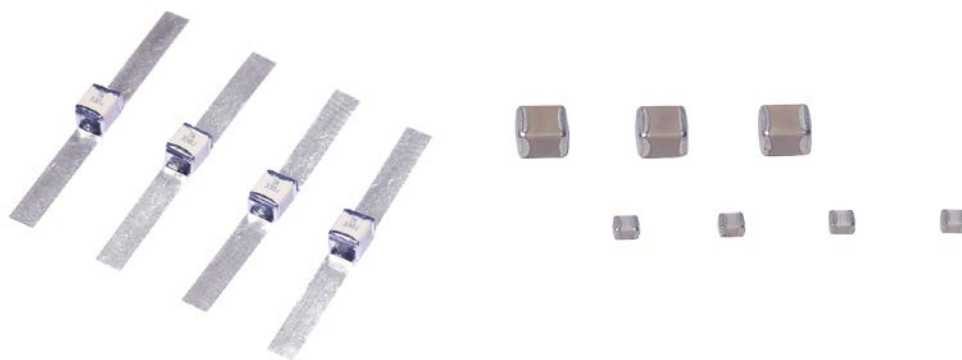

FEATURES

- Lowest ESR in class, High Self-Resonant Frequencies, RF capacitors
- Highest working voltage in class: 1,500V
- Standard EIA sizes: 0402 - 1111
- Capacitance range: 0.2pF - 1,000pF
- NPO, RoHS & REACH compliant
- Operating temperature up to 125°C*
- Laser Marked (optional)

APPLICATIONS

- Cellular Base Station Equipments
- Broadband Wireless Service
- Point to Point / Multipoint Radios
- RF Generators (NMR...)

CIRCUIT APPLICATIONS

- Filter Networks
- Matching Networks
- Tuning, Coupling and DC Blocking

PHYSICAL CHARACTERISTICS

- Chip capacitors for surface mounting with:
 - Copper barrier and tinning or Silver/Palladium (non magnetic)
 - Nickel barrier and tinning
- Ribbon leads for surface mounting

ELECTRICAL AND ENVIRONMENTAL SPECIFICATIONS

Electrical specifications	
Parameter	Value
Capacitance	0.2pF - 1,000pF
Tolerances	A, B, C, D below 10pF F, G, J, K above 10pF
Working voltage (W _{DC})	See capacitance range chart
Temperature coefficient	0 ±30ppm/°C, -55°C to +125°C For SHF and SHS: 0 ±30ppm/°C, -55°C to +150°C
Insulation Resistance	10 ⁵ MΩ min.
Dielectric Withstanding (test voltage applied for 5 seconds)	2.5 x W _{DC} for W _{DC} ≤ 500V 1.8 x W _{DC} for extended range values ≥ 820pF 1.5 x W _{DC} for W _{DC} > 500V
Aging	none
Piezo Effect	none

Environmental specifications	
Parameter	Value
Life Test	2,000 hours, +125°C at 2 x W _{DC} And SHB : 1,000 hours, +175°C at 1 x W _{DC}
Moisture Resistance Test 1	240 hours, 85% relative humidity at 85°C (ESA/SCC n°3009)
Moisture Resistance Test 2	56 days, 93% relative humidity at 40°C 0V, 5V, W _{DC}

* The temperature withstanding for SHF and SHS is 150°C for the whole capacitance range.

Capacitance	Breakdown voltage V _{peak} (V)
15 pF	2700
39 pF	2000
100 pF	1400

Typical Breakdown Voltage SHB 45 MHz DC = 1%

HOW TO ORDER

501	SH	B	100	J	S	-	L	E	-RoHS
Voltage code	Dielectric	Size code	Capacitance code	Tolerance code	Termination code	Ribbon code	Marking code	Tape and reel	
250 = 25V 500 = 50V 101 = 100V 201 = 200V 251 = 250V 301 = 300V 501 = 500V 601 = 600V 102 = 1,000V 152 = 1,500V Please refer to voltage given in capacitance range chart	SH = NPO: (0±30)ppm/°C	L = 0402 S = 0603 A = 0505 F = 0805 N = 1206 T = 1210 B = 1111	Please refer to Cap. Code given in capacitance range chart.	A = ±0.05pF B = ±0.1pF C = ±0.25pF D = ±0.5pF F = ±1% G = ±2% J = ±5% K = ±10% See note 1	S = Standard: tin-plated nickel Available on sizes 0505, 0603, 0805, 1111 and 1206: C = Non-magnetic: tin-plated copper Available on sizes 0505, 0805 [from 0.5pF to 150pF, consult us for higher cap. value], 1206 and 1210: A = Non-magnetic: silver/palladium See note 2	-: no lead or ribbon Available on size 1111: 1 = Micro-strip ribbons 6 = Radial Wires See note 3	-: no marking Available on sizes 0505 and 1111: L = laser marking	-: no tape and reel E = horizontal orientation X = vertical orientation Number of components per reel: SHL: 10,000 SHA: 3,000 SHS: 4,000 SHF: 4,000 SHN: 3,000 SHT: 3,000 SHB: 1,000	The RoHS tag is not part of the reference Tag added at the end of P/N for information

Note 1: For capacitance values less than 10pF, tolerances B, C and D available. Tolerance code A available for: L case for capacitance values of 0.2pF - 1.9pF. A case for capacitance values of 0.2pF - 4.7pF. S case for capacitance values of 0.2pF - 9.1pF. F case for capacitance values of 0.3pF - 2.2pF. N case for capacitance values of 0.5pF - 1.8pF. B case for capacitance values of 0.2pF - 3.3pF. For capacitance values of 10pF or higher, tolerances F, G, J and K available.

Note 2: All terminations are backward compatible and lead-free. The non-magnetic terminations are all Magnetism-free Rated.

Note 3: When coding ribbons for the description of the part, the termination has to be mentioned for MR certified types to ensure that only non-magnetic materials are used.

Note 4: Ribbon lead styles capacitors are not available in Tape and Reel.

Examples: 501 SHB 470 J1L any termination material could be used. 501 SHB 470 JC1L only non-magnetic termination materials could be used. Please consult us for specific requirements.

SH Series

Super HiQ

TYPICAL PERFORMANCE DATA

S-Parameters available with ABC software.

SHA (SIZE 0505): TYPICAL ESR VERSUS FREQUENCY

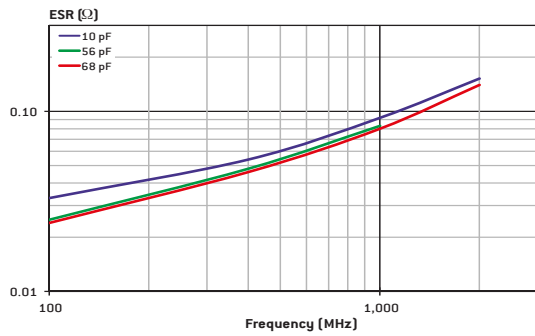

SHB (SIZE 1111): TYPICAL ESR VERSUS FREQUENCY

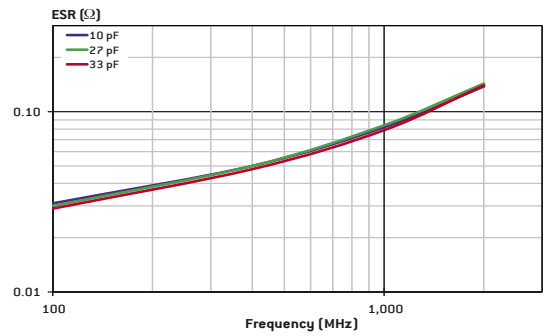

SHS (SIZE 0603): TYPICAL ESR VERSUS FREQUENCY

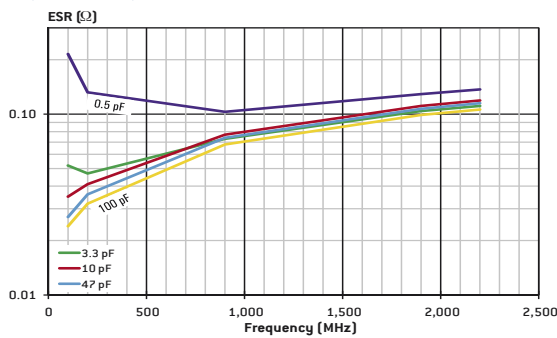

SHS (SIZE 0603): TYPICAL Q FACTOR VERSUS FREQUENCY

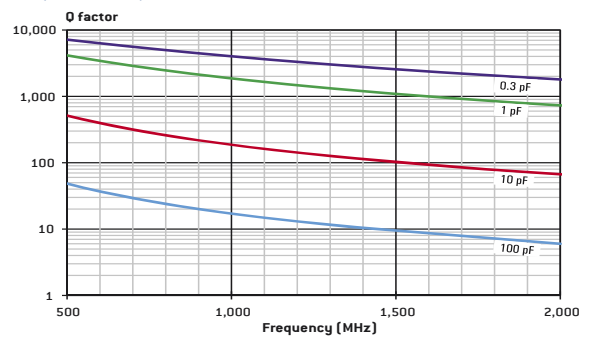

SHF (SIZE 0805): TYPICAL ESR VERSUS FREQUENCY

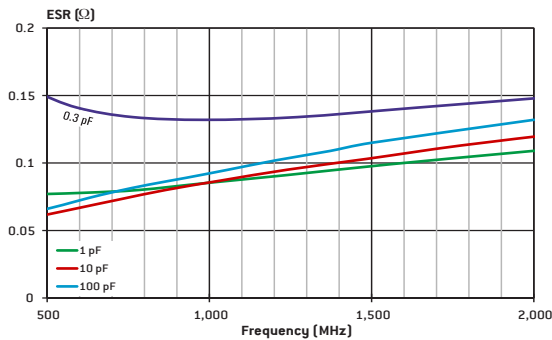

SHF (SIZE 0805): TYPICAL Q FACTOR VERSUS FREQUENCY

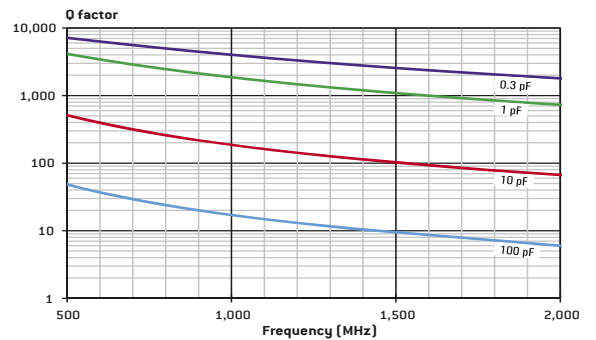

SHL (SIZE 0402): TYPICAL ESR VERSUS FREQUENCY

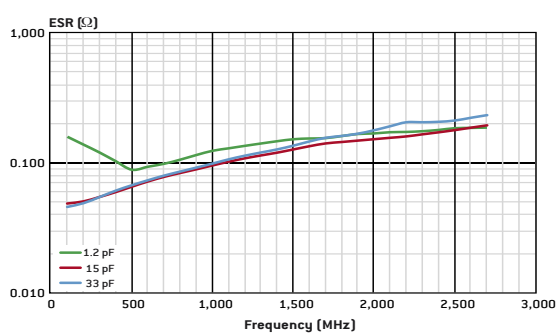

SHL (SIZE 0402): TYPICAL Q FACTOR VERSUS FREQUENCY

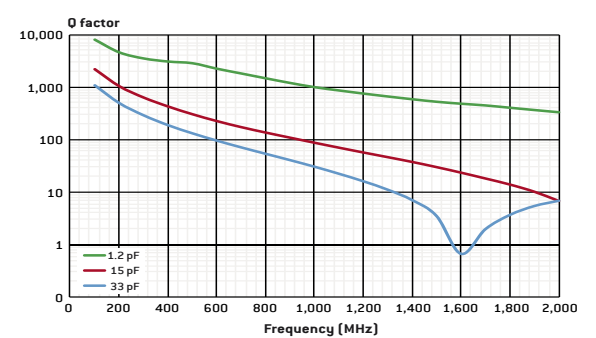

DIMENSIONS in inches (mm)

Chips

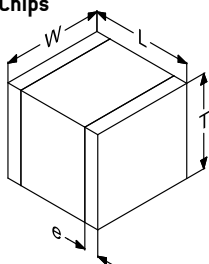

Micro-strip ribbon leads (Type 1)

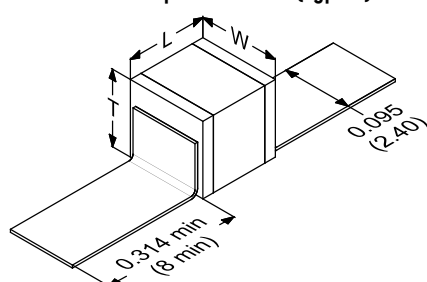

Radial leads: available on all sizes (Type 6)

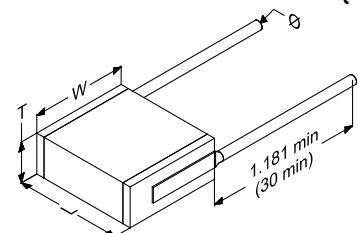

STANDARD RATINGS

Size		0402	0603	0505	0805	1206	1210	1111		
Size code		L	S	A	F	N	T	B		
Dimensions inches (mm)	L	0.039 ± 0.006 (1 ± 0.15)	0.063 ± 0.01 (1.6 ± 0.25)	0.055 ± 0.01 (1.4 ± 0.25)	0.08 ± 0.01 (2.03 ± 0.25)	0.125 ± 0.01 (3.18 ± 0.25)	0.125 ± 0.01 (3.18 ± 0.25)	0.110 ± 0.016 (2.80 ± 0.40)		
	W	0.02 ± 0.006 (0.5 ± 0.15)	0.032 ± 0.01 (0.8 ± 0.25)	0.055 ± 0.01 (1.4 ± 0.25)	0.05 ± 0.01 (1.27 ± 0.25)	0.062 ± 0.01 (1.58 ± 0.25)	0.095 ± 0.01 (2.41 ± 0.25)	0.110 ± 0.016 (2.80 ± 0.40)		
	T	0.02 max (0.51 max)	0.036 max (0.9 max)	0.056 max (1.4 max)	0.05 max (1.27 max)	0.05 max (1.27 max)	0.06 max (1.52 max)	0.103 max (2.60 max)		
	e	0.01 ± 0.006 (0.25 ± 0.15)	0.014 ± 0.008 (0.35 ± 0.2)	0.01 ± 0.006 (0.25 ± 0.15)	0.02 ± 0.012 (0.5 ± 0.3)	0.02 ± 0.01 (0.5 ± 0.25)	0.02 ± 0.01 (0.5 ± 0.25)	0.016 ± 0.010 (0.40 ± 0.25)		
Value (pF)	Cap. Code	Standard	Standard	Standard	Standard	Standard	Standard	Standard	Extended	
0.1	0R1	50 - 250V								
0.2	0R2									
0.3	0R3									
0.4	0R4									
0.5	0R5									
0.6	0R6									
0.7	0R7									
0.8	0R8									
0.9	0R9									
1.0	1R0									
1.1	1R1									
1.2	1R2									
1.3	1R3									
1.4	1R4									
1.5	1R5									
1.6	1R6									
1.7	1R7									
1.8	1R8									
1.9	1R9									
2.0	2R0	250V		250V		500V				
2.1	2R1									
2.2	2R2									
2.4	2R4									
2.7	2R7									
3.0	3R0									
3.3	3R3									
3.6	3R6									
3.9	3R9									
4.3	4R3									
4.7	4R7									
5.1	5R1									
5.6	5R6									
6.2	6R2									
6.8	6R8									
7.5	7R5									
8.2	8R2									
9.1	9R1									
10	100	50 - 200V				500V				
11	110									
12	120									
15	150									
16	160									
18	180									
20	200									
22	220									
24	240									
27	270									
30	300									
33	330									
36	360									
39	390									
43	430									
47	470									
51	510									
56	560									
62	620									
68	680									
75	750									
82	820									
91	910									
100	101	25 - 50V								
110	111									
120	121									
130	131									
150	151									
160	161									
180	181									
200	201									
220	221									
240	241									
270	271									
300	301									
330	331									
360	361									
390	391									
430	431									
470	471									
510	511									
560	561									
620	621									
680	681									
750	751									
820	821									
910	911									
1.000	102									
				150V R12N Series (See page 26)				200V	600V	
							100V		300V	1,000V
								100V		
									100V	
									50V	300V

Special values, tolerances, higher W_{VDC} and matching available, please consult factory.

SHR / SHD Series

Reverse Geometry



FEATURES

- Reverse-Geometry MLCC providing Ultra low ESL and very High Self Resonant Frequencies
- High power dissipation
- Lowest ESR in class, RF & Microwave capacitors
- Working voltage: 500V
- Sizes: 0709 and 0711
- Capacitance range: 0.5pF - 100pF
- NPO, RoHS compliant
- Operating temperature up to 175°C
- Laser Marked (optional)

APPLICATIONS

- Cellular Base Station Equipments
- Broadband Wireless Service
- Point to Point / Multipoint Radios
- Broadcasting Equipment

CIRCUIT APPLICATIONS

- Impedance Matching
- Bypass, Feedback
- Tuning, Coupling and DC Blocking

PHYSICAL CHARACTERISTICS

Chip capacitors for surface mounting with Nickel barrier and tinning.

ELECTRICAL AND ENVIRONMENTAL SPECIFICATIONS

Electrical specifications	
Parameter	Value
Capacitance	0.5pF - 100pF
Tolerances	A, B, C, D below 10pF F, G, J, K above 10pF
Working voltage (WV _{DC})	500V
Temperature coefficient	NPO: [0 ± 30] ppm/°C, -55°C to +175°C
Insulation Resistance	10 ⁵ MΩ min.
Dielectric Withstanding (test voltage applied for 5 seconds)	1,250V
Aging	none
Piezo Effect	none

Environmental specifications	
Parameter	Value
Life Test	2,000 hours, +125°C at 1,000V 1,000 hours, +175°C at 500V
Moisture Resistance Test 1	240 hours, 85% relative humidity at 85°C (ESA/SCC n°3009)
Moisture Resistance Test 2	56 days, 93% relative humidity at 40°C 0V, 5V, WV _{DC}

HOW TO ORDER

501	SH	R	100	J	S	L	E	-RoHS
Voltage code	Dielectric	Size code	Capacitance code	Tolerance code	Termination code	Marking code	Tape and reel	
501 = 500V	SH = NPO: [0±30] ppm/°C	R = 0709 D = 0711	Please refer to Cap. Code given in capacitance range chart	A = ±0.05pF B = ±0.1pF C = ±0.25pF D = ±0.5pF F = ±1% G = ±2% J = ±5% K = ±10% See note	S = Standard: tin-plated nickel All terminations are backward compatible and lead-free	-: no marking L = laser marking	-: no tape and reel E = Tape and reel packaging Number of components per reel: 1,000.	The RoHS tag is not part of the reference Tag added at the end of P/N for information

Note: For capacitance values less than 3.3pF, tolerances A, B, C and D are available. For capacitance values less than 10pF, tolerances B, C and D are available. For capacitance values of 10pF or higher, tolerances F, G, J and K are available. Please consult us for specific requirements.

Reverse Geometry

SHR / SHD Series

DIMENSIONS in inches (mm)

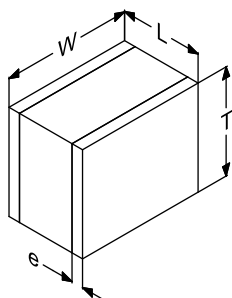

TYPICAL ESR VERSUS FREQUENCY

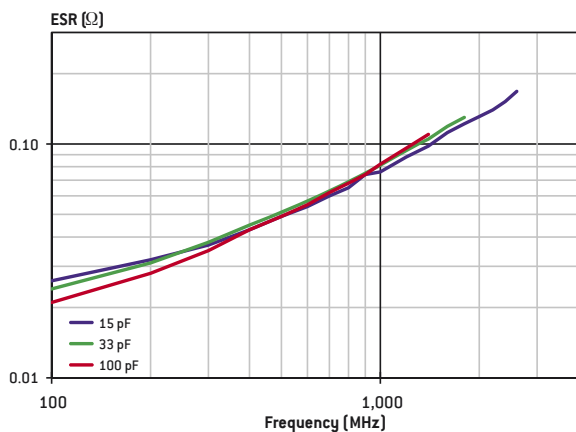

TYPICAL SERIES RESONANT FREQUENCY VERSUS CAPACITANCE

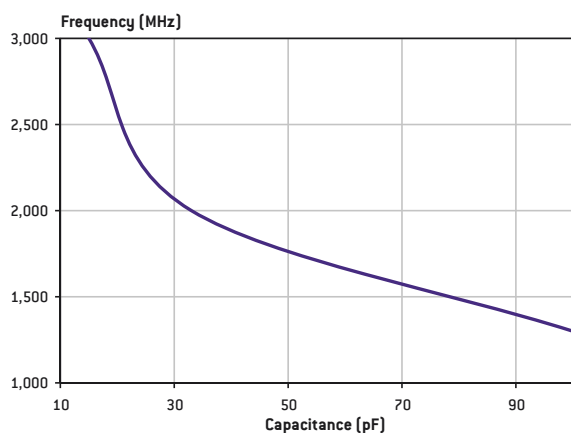

STANDARD RATINGS

Size		0709	0711
Size code		R	D
Dimensions inches (mm)	L	0.07 ± 0.015 (1.78 ± 0.38)	0.07 ± 0.015 (1.78 ± 0.38)
	W	0.09 ± 0.01 (2.29 ± 0.25)	0.105 ± 0.01 (2.67 ± 0.25)
	T	0.106 max (2.67 max)	0.09 max (2.29 max)
	e	0.01 +0.008/-0.006 (0.25 +0.2/-0.15)	0.01 +0.008/-0.006 (0.25 +0.2/-0.15)
Value (pF)	Cap. Code	Standard	Standard
0.5	OR5		
0.6	OR6		
0.7	OR7		
0.8	OR8		
0.9	OR9		
1.0	1R0		
1.1	1R1		
1.2	1R2		
1.3	1R3		
1.4	1R4		
1.5	1R5		
1.6	1R6		
1.7	1R7		
1.8	1R8		
1.9	1R9		
2.0	2R0		
2.1	2R1		
2.2	2R2		
2.4	2R4		
2.7	2R7		
3.0	3R0		
3.3	3R3		
3.6	3R6		
3.9	3R9		
4.3	4R3		
4.7	4R7		
5.1	5R1		
5.6	5R6		
6.2	6R2	500V	500V
6.8	6R8		
7.5	7R5		
8.2	8R2		
9.1	9R1		
10	100		
11	110		
12	120		
15	150		
16	160		
18	180		
20	200		
22	220		
24	240		
27	270		
30	300		
33	330		
36	360		
39	390		
43	430		
47	470		
51	510		
56	560		
62	620		
68	680		
75	750		
82	820		
91	910		
100	101		



FEATURES

- High RF power MLCC
- Very high self resonant frequencies, lowest ESR in class, RF & Microwave capacitors
- Working voltage: 500V
- Size: 1111
- Capacitance range: 0.3pF - 100pF
- NPO, RoHS compliant
- Operating temperature up to 175°C
- Laser Marked (optional)

APPLICATIONS

- Cellular Base Station Equipments
- Broadband Wireless Service
- Point to Point / Multipoint Radios
- Broadcasting Equipment

CIRCUIT APPLICATIONS

- Impedance Matching
- Bypass, Feedback
- Tuning, Coupling and DC Blocking

PHYSICAL CHARACTERISTICS

Chip capacitors for surface mounting with Nickel barrier and tinning.

HOW TO ORDER

501	NH	B	100	J	S	L	E	-RoHS
Voltage code	Dielectric	Size code	Capacitance code	Tolerance code	Termination code	Marking code	Tape and reel	
501 = 500V	NH = NPO: [0±30] ppm/°C	B = 1111	Please refer to Cap. Code given in capacitance range chart	A = ±0.05pF B = ±0.1pF C = ±0.25pF D = ±0.5pF F = ±1% G = ±2% J = ±5% K = ±10% See note	S = Standard: tin-plated nickel All terminations are backward compatible and lead-free	-: no marking L = laser marking	-: no tape and reel E = Tape and reel packaging Number of components per reel: 1,000.	The RoHS tag is not part of the reference Tag added at the end of P/N for information

Note: For capacitance values less than 3.3pF, tolerances A, B, C and D are available. For capacitance values less than 10pF, tolerances B, C and D are available. For capacitance values of 10pF or higher, tolerances F, G, J and K are available. Please consult us for specific requirements.

ELECTRICAL AND ENVIRONMENTAL SPECIFICATIONS

Electrical specifications	
Parameter	Value
Capacitance	0.3pF - 100pF
Tolerances	A, B, C, D below 10pF F, G, J, K above 10pF
Working voltage [WV _{DC}]	500V
Temperature coefficient	NPO: [0 ± 30] ppm/°C, -55°C to +175°C
Insulation Resistance	10 ⁵ MΩ min.
Dielectric Withstanding (test voltage applied for 5 seconds)	1,250V
Aging	none
Piezo Effect	none

Environmental specifications	
Parameter	Value
Life Test	1,000 hours, +175°C at 500V 2,000 hours, +125°C at 1,000V
Moisture Resistance Test 1	240 hours, 85% relative humidity at 85°C (ESA/SCC n°3009)
Moisture Resistance Test 2	56 days, 93% relative humidity at 40°C 0V, 5V, WV _{DC}

Capacitance	Breakdown voltage V _{peak} (V)
39 pF	1400
100 pF	1100

Typical Breakdown Voltage NHB 45 MHz DC = 1%

High Self Resonant Frequency

NHB Series

DIMENSIONS in inches (mm)

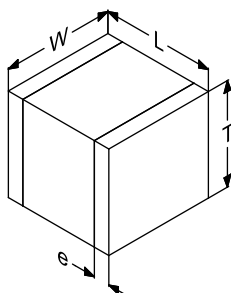

TYPICAL ESR VERSUS FREQUENCY

Capacitance value = 33pF

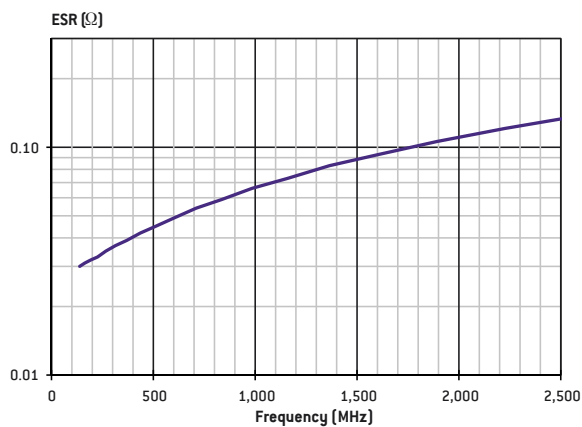

TYPICAL SRF VERSUS FREQUENCY

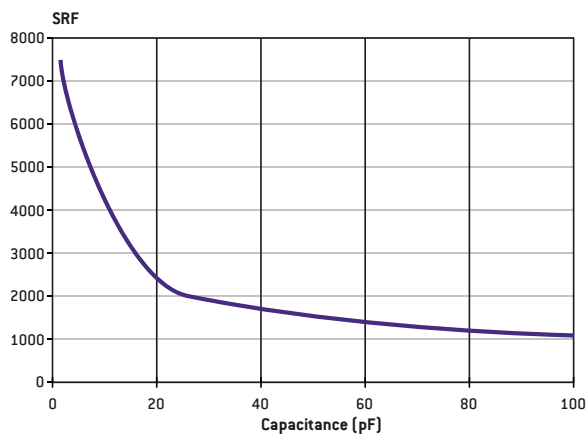

STANDARD RATINGS

Size		1111
Size code		B
Dimensions inches (mm)	L	0.11 ± 0.016 (2.8 ± 0.4)
	W	0.11 ± 0.016 (2.8 ± 0.4)
	T	0.103 max (2.6 max)
	e	0.016 ± 0.01 (0.4 ± 0.25)
Value (pF)	Cap. Code	Standard
0.3	OR3	
0.4	OR4	
0.5	OR5	
0.6	OR6	
0.7	OR7	
0.8	OR8	
0.9	OR9	
1.0	1R0	
1.1	1R1	
1.2	1R2	
1.3	1R3	
1.4	1R4	
1.5	1R5	
1.6	1R6	
1.7	1R7	
1.8	1R8	
1.9	1R9	
2.0	2R0	
2.1	2R1	
2.2	2R2	
2.4	2R4	
2.7	2R7	
3.0	3R0	
3.3	3R3	
3.6	3R6	
3.9	3R9	
4.3	4R3	
4.7	4R7	
5.1	5R1	
5.6	5R6	500V
6.2	6R2	
6.8	6R8	
7.5	7R5	
8.2	8R2	
9.1	9R1	
10	100	
11	110	
12	120	
15	150	
16	160	
18	180	
20	200	
22	220	
24	240	
27	270	
30	300	
33	330	
36	360	
39	390	
43	430	
47	470	
51	510	
56	560	
62	620	
68	680	
75	750	
82	820	
91	910	
100	101	

Special values, tolerances, higher WV_{DC} and matching available, please consult factory.

CP Series

High Power

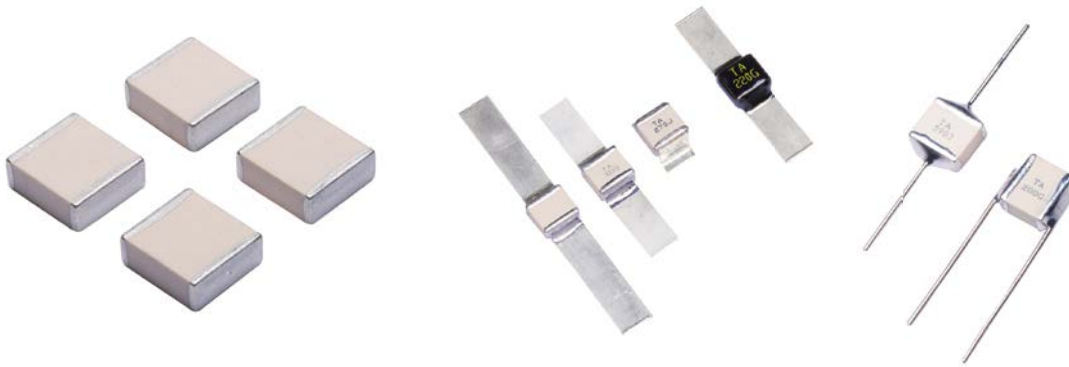

FEATURES

- Low ESR/ESL, RF power capacitors
- Porcelain capacitors P100, RoHS compliant
- Excellent characteristics in current, voltage and power with high Q factor
- Working voltage: 200V - 7,200V
- Sizes: 2225 and 4040
- Capacitance range: 1pF - 10,000pF
- Laser Marked (optional)

APPLICATIONS

- RF Power Amplifiers
- Industrial (Plasma Chamber)
- Medical (MRI Coils)

CIRCUIT APPLICATIONS

- DC Blocking
- Matching Networks
- Tuning and Coupling

PHYSICAL CHARACTERISTICS

- Chip capacitors for surface mounting with Nickel barrier and tinning or Copper barrier and tinning (non magnetic)
- Ribbon leads for surface mounting, axial or radial leads for through-hole circuits

HOW TO ORDER

362	CP	X	100	G	C	1	-	L	E	-RoHS
Voltage code	Dielectric	Size code	Capacitance code	Tolerance code	Termination code	Lead / Ribbon code	Coating code	Marking code	Tape and reel	
201 = 200V 301 = 300V 501 = 500V 102 = 1,000V 122 = 1,200V 152 = 1,500V 162 = 1,600V 252 = 2,500V 362 = 3,600V 502 = 5,000V 702 = 7,000V 722 = 7,200V Please refer to voltage given in capacitance range chart	CP = (100±30) ppm/°C	X = 2225 E = 4040	Please refer to Cap. Code given in capacitance range chart	B = ±0.1pF C = ±0.25pF D = ±0.5pF F = ±1% G = ±2% J = ±5% K = ±10% See note 1	S = Standard: tin-plated nickel C = Non-magnetic: tin-plated copper See note 2	-: no lead or ribbon 1 = Micro-strip ribbons, RoHS 6 = Radial leads, non RoHS 7 = Axial leads, non RoHS <u>Available on size 4040:</u> 1S = Short micro-strip ribbons, RoHS 2 = Axial ribbons, RoHS 3 = Radial ribbons, RoHS See note 3	-: no coating H = coating requested	-: no marking L = laser marking	-: no tape and reel E = horizontal orientation CPX: 500 components per reel CPE: 500 or 700 components per reel X = vertical orientation, only available on CPE, 350 components per reel	The RoHS tag is not part of the reference Tag added at the end of P/N for information

Note 1: For capacitance values less than 10pF, tolerances B, C and D available. For capacitance values equal to or higher than 10pF, tolerances F, G, J and K available.
 Note 2: All terminations are backward compatible and lead-free. The non-magnetic terminations are all Magnetism-free Rated.
 Note 3: When coding ribbons or leads for the description of the part, the termination has to be mentioned for MR certified types to ensure that only non-magnetic materials.
 Note 4: Ribbon lead styles capacitors are 10V available in Tape and Reel.
Examples: 362 CPE 470 J1L any termination material could be used. 362 CPE 470 JC1L only non-magnetic termination materials could be used.
 Please consult us for specific requirements.

ELECTRICAL AND ENVIRONMENTAL SPECIFICATIONS

Electrical specifications	
Parameter	Value
Capacitance	1pF - 10,000pF
Tolerances	B, C, D below 10pF F, G, J, K above 10pF
Working voltage (WV _{DC})	See capacitance range chart
Temperature coefficient	(100 ± 30) ppm/°C, -55°C to +125°C
Insulation Resistance	10 ⁵ MΩ min at 25°C at rated WV _{DC} 10 ⁴ MΩ min at 125°C at rated WV _{DC}
Dielectric Withstanding (test voltage applied for 5 seconds)	2 x WV _{DC} for WV _{DC} ≤ 500V 1.5 x WV _{DC} for 500V < WV _{DC} ≤ 2,500V 1.3 x WV _{DC} for WV _{DC} > 2,500V
Aging	none
Piezo Effect	none

Environmental specifications	
Parameter	Value
Life Test	2,000 hours, +125°C at 1.5 x WV _{DC} (WV _{DC} ≤ 500V) at 1.3 x WV _{DC} (500V < WV _{DC} < 1,250V) at 1 x WV _{DC} (1,250V ≤ WV _{DC})
Moisture Resistance Test 1	240 hours, 85% relative humidity at 85°C (ESA/SCC n°3009)
Moisture Resistance Test 2	56 days, 93% relative humidity at 40°C 0V, 5V, WV _{DC} or 500V whichever is less

High Power

CP Series

2225: TYPICAL ESR VERSUS CAPACITANCE

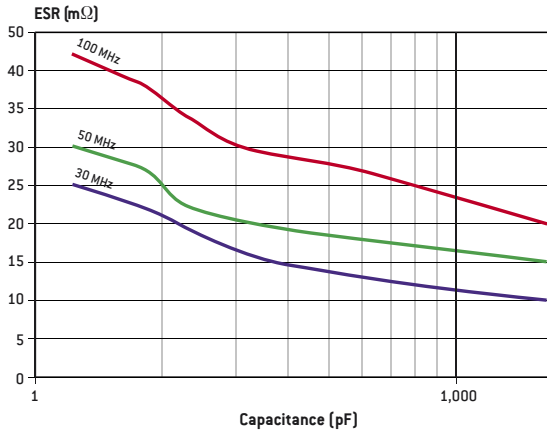

4040: TYPICAL ESR VERSUS CAPACITANCE

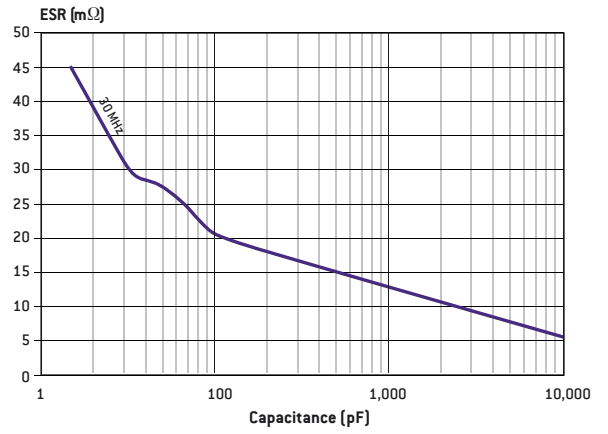

2225: TYPICAL CURRENT RATING VERSUS CAPACITANCE

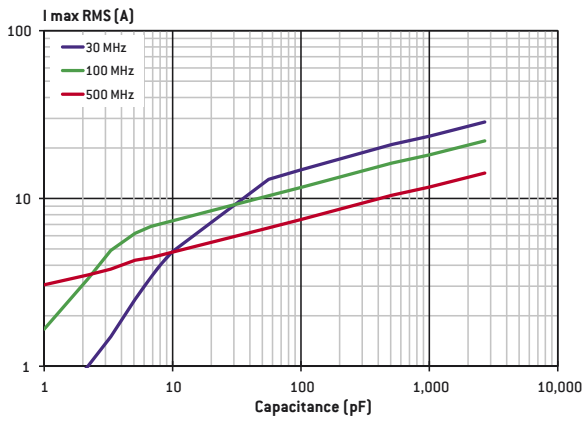

4040: TYPICAL CURRENT RATING VERSUS CAPACITANCE

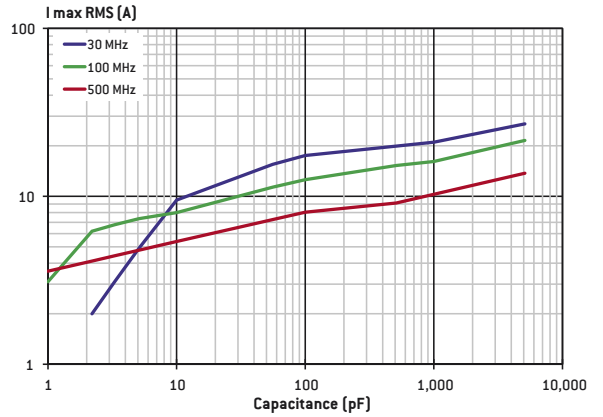

2225: TYPICAL SERIES RESONANT FREQUENCY VERSUS CAPACITANCE

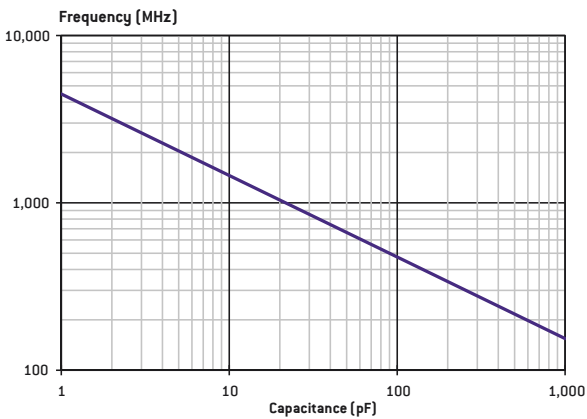

DIMENSIONS in inches (mm)

Chips

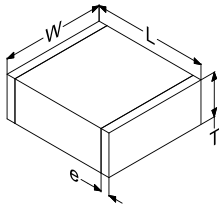

Micro-strip ribbons: available on all sizes (Type 1)

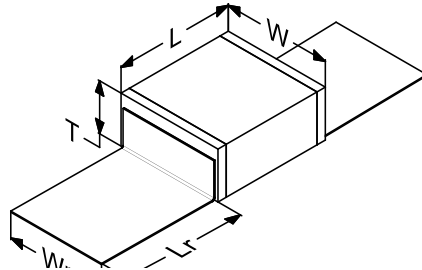

Short Micro-strip ribbons: available on size E (4040) (Type 1S)

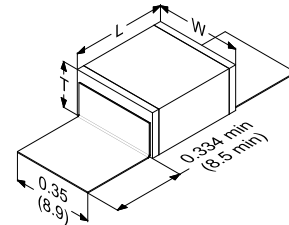

Axial ribbons: available on size E (4040) (Type 2)

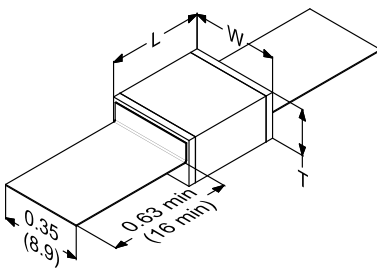

Radial ribbons: available on size E (4040) (Type 3)

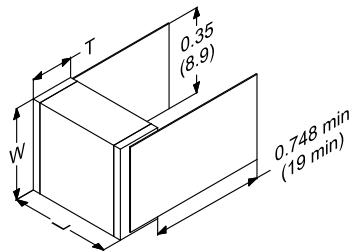

Radial leads: available on all sizes (Type 6)

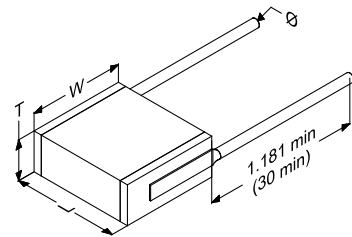

Axial leads: available on sizes X (2225) and E (4040) (Type 7)

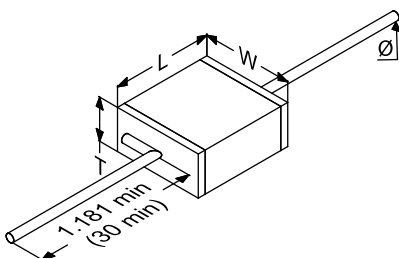

High Power

CP Series

STANDARD RATINGS

Size		2225		4040	
Size code		X		E	
Dimensions inches (mm)	L	0.244 +0.012 / -0.028 (6.2 +0.3 / -0.7)		0.413 +0.012 / -0.028 (10.5 +0.3 / -0.7)	
	W	0.26 ± 0.02 (6.6 ± 0.5)		0.374 ± 0.02 (9.5 ± 0.5)	
	T	0.15 max (3.8 max)		0.177 max (4.5 max)	
	e	0.032 ± 0.024 (0.8 ± 0.6)		0.032 ± 0.024 (0.8 ± 0.6)	
	Lr	0.472 min (12 min)		0.63 min (16 min)	
	Wr	0.213 (5.4)		0.35 (8.9)	
	Ø	0.024 (0.60)		0.035 (0.90)	
Value (pF)	Cap. Code	Standard	Extended	Standard	Extended
1.0	1R0				
1.1	1R1				
1.2	1R2				
1.3	1R3				
1.4	1R4				
1.5	1R5				
1.6	1R6				
1.7	1R7				
1.8	1R8				
1.9	1R9				
2.0	2R0				
2.1	2R1				
2.2	2R2				
2.4	2R4				
2.7	2R7				
3.0	3R0				
3.3	3R3				
3.6	3R6				
3.9	3R9				
4.3	4R3				
4.7	4R7				
5.1	5R1				
5.6	5R6	2,500V	3,600V	3,600V	7,200V
6.2	6R2				
6.8	6R8				
7.5	7R5				
8.2	8R2				
9.1	9R1				
10	100				
11	110				
12	120				
13	130				
15	150				
16	160				
18	180				
20	200				
22	220				
24	240				
27	270				
30	300				
33	330				
36	360				
39	390				
43	430				
47	470				
51	510				

Special values, tolerances, higher WV_{DC} and matching available, please consult factory.

Size		2225		4040	
Size code		X		E	
Dimensions inches (mm)	L	0.244 +0.012 / -0.028 (6.2 +0.3 / -0.7)		0.413 +0.012 / -0.028 (10.5 +0.3 / -0.7)	
	W	0.26 ± 0.02 (6.6 ± 0.5)		0.374 ± 0.02 (9.5 ± 0.5)	
	T	0.15 max (3.8 max)		0.177 max (4.5 max)	
	e	0.032 ± 0.024 (0.8 ± 0.6)		0.032 ± 0.024 (0.8 ± 0.6)	
	Lr	0.472 min (12 min)		0.63 min (16 min)	
	Wr	0.213 (5.4)		0.35 (8.9)	
	Ø	0.024 (0.60)		0.035 (0.90)	
Value (pF)	Cap. Code	Standard	Extended	Standard	Extended
56	560				
62	620				
68	680				
75	750		3,600V		7,200V
82	820				
91	910				
100	101				
110	111				
120	121	2,500V			
130	131				
150	151			3,600V	
160	161				
180	181				
200	201				
220	221				
240	241				5,000V
270	271				
300	301				
330	331				
360	361	1,500V			
390	391				
430	431				
470	471				
510	511				
560	561			2,500V	
620	621				
680	681				
750	751	1,200V			
820	821				
910	911			1,600V	
1,000	102				
1,100	112				
1,200	122				2,000V
1,500	152	500V		1,000V	
1,800	182				
2,200	222	300V			
2,700	272				
3,000	302				
3,300	332				
3,900	392			500V	
4,700	472				
5,100	512				
5,600	562				
6,800	682				
8,200	822			200V	
10,000	103				

Special values, tolerances, higher WV_{DC} and matching available, please consult factory.

CL Series

High Power

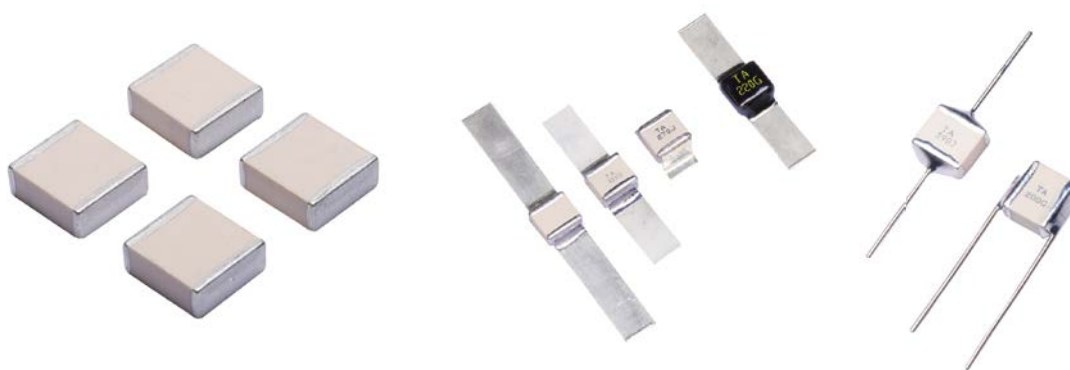

FEATURES

- Low ESR/ESL, RF power capacitors
- NPO capacitors, ultra stability
- RoHS compliant
- Excellent characteristics in current, voltage and power with high Q factor
- Working voltage: 200V - 7,200V
- Sizes: 2225, 4040 and 7065
- Capacitance range: 1pF - 10,000pF
- Laser Marked (optional)

APPLICATIONS

- RF Power Amplifiers
- Industrial (Plasma Chamber)
- Medical (MRI Coils)

CIRCUIT APPLICATIONS

- DC Blocking
- Matching Networks
- Tuning and Coupling

PHYSICAL CHARACTERISTICS

- Chip capacitors for surface mounting with Nickel barrier and tinning or Copper barrier and tinning (non magnetic)
- Ribbon leads for surface mounting, axial or radial leads for through-hole circuits

HOW TO ORDER

362	CL	X	100	G	C	1	-	L	-	-RoHS
Voltage code	Dielectric	Case size	Capacitance code	Tolerance code	Termination code	Lead / Ribbon code	Coating code	Marking code	Tape and reel	
201 = 200V 301 = 300V 501 = 500V 102 = 1,000V 122 = 1,200V 152 = 1,500V 162 = 1,600V 252 = 2,500V 362 = 3,600V 502 = 5,000V 702 = 7,000V 722 = 7,200V	CL = NPO: (0±30) ppm/°C	X = 2225 E = 4040 F = 7065	Please refer to capacitance code given in capacitance range chart	B = ±0.1pF C = ±0.25pF D = ±0.5pF F = ±1% G = ±2% J = ±5% K = ±10% See note 1	S = Standard: tin-plated nickel Available on sizes 2225 and 4040: C = Non-magnetic: tin-plated copper Available on size 7065: A = Non-magnetic: silver-palladium See note 2	-: no lead or ribbon 1 = Micro-strip ribbons, RoHS 6 = Radial leads, non RoHS Available on size 4040: 1S = Short micro-strip ribbons, RoHS. 2 = Axial ribbons, RoHS. 3 = Radial ribbons, RoHS. Available on sizes 2225 and 4040: 7 = Axial leads, non RoHS. See note 3	-: no coating H = coating requested	-: no marking L = laser marking	-: no tape and reel Available on sizes 2225 and 4040: E = horizontal orientation CLX: 500 components per reel CLE: 500 or 700 components per reel Available on size 4040: X = vertical orientation, only available on CLE, 350 components per reel	The RoHS tag is not part of the reference Tag added at the end of P/N for information
Please refer to voltage given in capacitance range chart										

ELECTRICAL AND ENVIRONMENTAL SPECIFICATIONS

Electrical specifications	
Parameter	Value
Capacitance	1pF - 10,000pF
Tolerances	B, C, D below 10pF F, G, J, K, M above 10pF
Working voltage (W _{DC})	See capacitance range chart
Temperature coefficient	NPO: [0 ± 30] ppm/°C, -55°C to +125°C
Insulation Resistance	10 ⁵ MΩ min at 25°C at rated W _{DC} 10 ⁴ MΩ min at 125°C at rated W _{DC}
Dielectric Withstanding (test voltage applied for 5 seconds)	2 x W _{DC} for W _{DC} ≤ 500V 1.5 x W _{DC} for 500V < W _{DC} ≤ 2,500V 1.3 x W _{DC} for W _{DC} > 2,500V
Aging	none
Piezo Effect	none

Environmental specifications	
Parameter	Value
Life Test	2,000 hours, +125°C at 1.5 x W _{DC} (W _{DC} ≤ 500V) at 1.3 x W _{DC} (500V < W _{DC} < 1,250V) at 1 x W _{DC} (1,250V ≤ W _{DC})
Moisture Resistance Test 1	240 hours, 85% relative humidity at 85°C (ESA/SCC n°3009)
Moisture Resistance Test 2	56 days, 93% relative humidity at 40°C 0V, 5V, W _{DC} or 500V whichever is less

Capacitance	Breakdown voltage V _{peak} (V)
12 pF	>9500
47 pF	6000
47 pF TK239	8800

Typical Breakdown Voltage CLE with black coating 50 MHz DC = 1%

High Power

CL Series

2225: TYPICAL ESR VERSUS CAPACITANCE

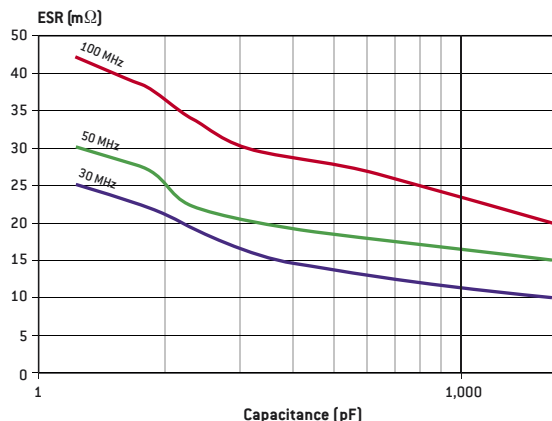

4040: TYPICAL ESR VERSUS CAPACITANCE

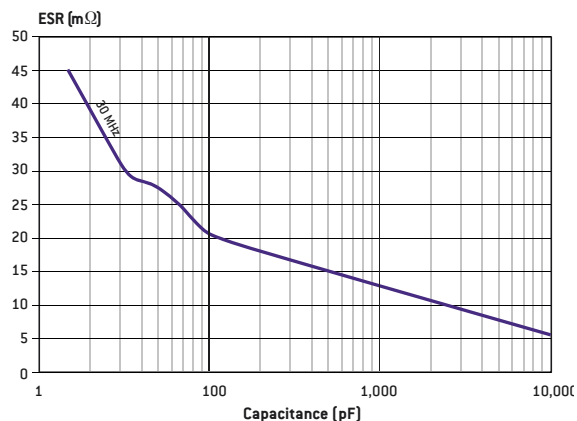

2225: TYPICAL CURRENT RATING VERSUS CAPACITANCE

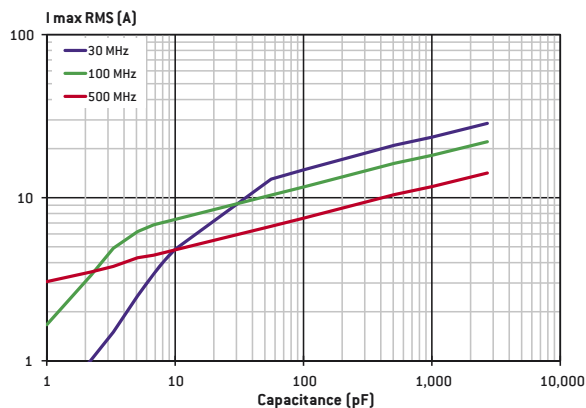

4040: TYPICAL CURRENT RATING VERSUS CAPACITANCE

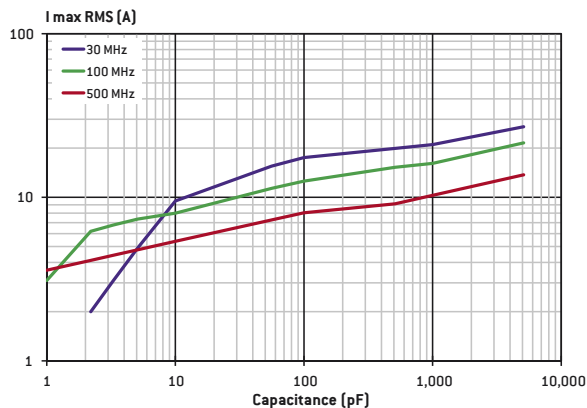

2225: TYPICAL SERIES RESONANCE FREQUENCY VERSUS CAPACITANCE

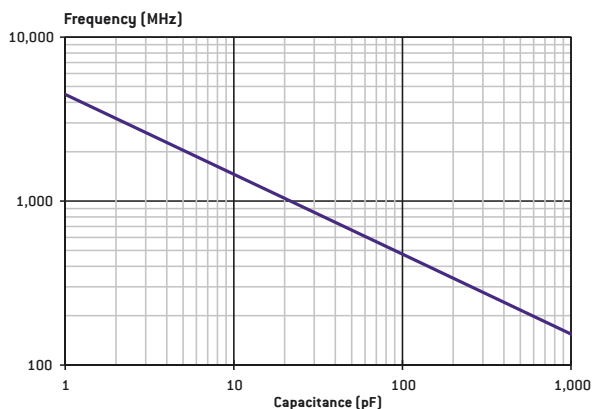

Note 1:

- For capacitance values less than 10pF, tolerances B, C and D available.
- For capacitance values equal to or higher than 10pF, tolerances F, G, J and K available.

Note 2:

- All terminations are backward compatible and lead-free
- The non-magnetic terminations are all Magnetism-free Rated

Note 3: when coding ribbons or leads for the description of the part, the termination has to be mentioned for MR certified types to ensure that only non-magnetic materials are used.

Note 4: Ribbon lead styles capacitors are not available in Tape and Reel.

Examples: 362 CLE 470 J1L any termination material could be used
 362 CLE 470 JC1L only non-magnetic termination materials could be used

Please consult us for specific requirements.

DIMENSIONS in inches (mm)

Chips

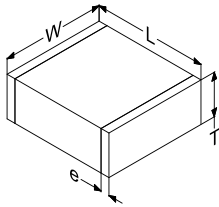

Micro-strip ribbons: available on all sizes (Type 1)

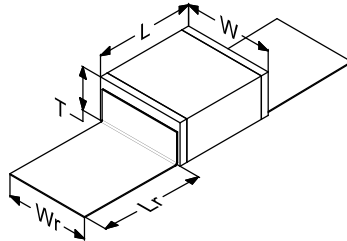

Short Micro-strip ribbons: available on size E (4040) (Type 1S)

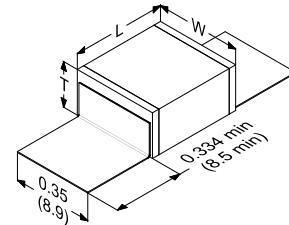

Axial ribbons: available on size E (4040) (Type 2)

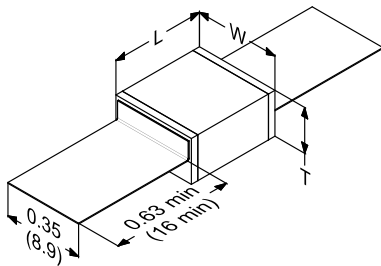

Radial ribbons: available on size E (4040) (Type 3)

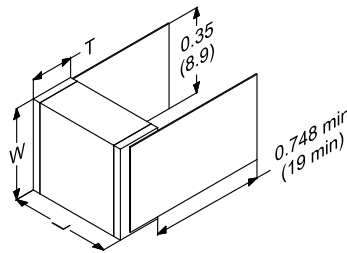

Radial leads: available on all sizes (Type 6)

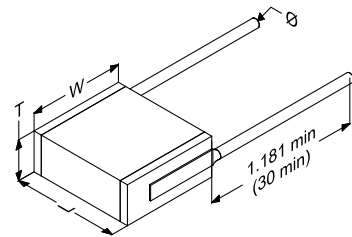

Axial leads: available on sizes X (2225) and E (4040) (Type 7)

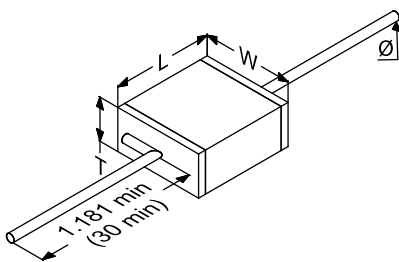

High Power

CL Series

STANDARD RATINGS

Size		2225		4040	
Size code		X		E	
Dimensions inches (mm)	L	0.244 +0.012 / -0.028 (6.2 +0.3 / -0.7)		0.413 +0.012 / -0.028 (10.5 +0.3 / -0.7)	
	W	0.26 ± 0.02 (6.6 ± 0.5)		0.374 ± 0.02 (9.5 ± 0.5)	
	T	0.15 max (3.8 max)		0.177 max (4.5 max)	
	e	0.032 ± 0.024 (0.8 ± 0.6)		0.032 ± 0.024 (0.8 ± 0.6)	
	Lr	0.472 min (12 min)		0.63 min (16 min)	
	Wr	0.213 (5.4)		0.35 (8.9)	
	∅	0.024 (0.60)		0.035 (0.90)	
	Value (pF)	Cap. Code	Standard	Extended	Standard
1.0	1R0				
1.1	1R1				
1.2	1R2				
1.3	1R3				
1.4	1R4				
1.5	1R5				
1.6	1R6				
1.7	1R7				
1.8	1R8				
1.9	1R9				
2.0	2R0				
2.1	2R1				
2.2	2R2				
2.4	2R4				
2.7	2R7				
3.0	3R0				
3.3	3R3				
3.6	3R6				
3.9	3R9				
4.3	4R3				
4.7	4R7				
5.1	5R1				
5.6	5R6	2,500V	3,600V	3,600V	7,200V
6.2	6R2				
6.8	6R8				
7.5	7R5				
8.2	8R2				
9.1	9R1				
10	100				
11	110				
12	120				
13	130				
15	150				
16	160				
18	180				
20	200				
22	220				
24	240				
27	270				
30	300				
33	330				
36	360				
39	390				
43	430				
47	470				
51	510				

Special values, tolerances, higher WV_{DC} and matching available, please consult factory.

Size		2225		4040		7065	
Size code		X		E		F	
Dimensions inches (mm)	L	0.244 +0.012 / -0.028 (6.2 +0.3 / -0.7)		0.413 +0.012 / -0.028 (10.5 +0.3 / -0.7)		0.244 +0.012 / -0.028 0.701 ± 0.02	
	W	0.26 ± 0.02 (6.6 ± 0.5)		0.374 ± 0.02 (9.5 ± 0.5)		[17.8 ± 0.5] 0.63 ± 0.02	
	T	0.15 max (3.8 max)		0.177 max (4.5 max)		[16 ± 0.5] 0.158 max	
	e	0.032 ± 0.024 (0.8 ± 0.6)		0.032 ± 0.024 (0.8 ± 0.6)		[4 max] 0.032 ± 0.024	
	Lr	0.472 min (12 min)		0.63 min (16 min)		[0.8 ± 0.6] 0.236 min	
	Wr	0.213 (5.4)		0.35 (8.9)		[6 min] 0.591	
	∅	0.024 (0.60)		0.035 (0.90)		[15] 0.035	
	Value (pF)	Cap. Code	Standard	Extended	Standard	Extended	Standard
56	560						
62	620						
68	680						
75	750						
82	820						
91	910						
100	101						
110	111						
120	121						
130	131						
150	151						
160	161						
180	181						
200	201						
220	221						
240	241						
270	271						
300	301						
330	331						
360	361						
390	391						
430	431						
470	471						
510	511						
560	561						
620	621						
680	681						
750	751						
820	821						
910	911						
1,000	102						
1,100	112						
1,200	122						
1,500	152						
1,800	182						
2,200	222						
2,700	272						
3,000	302						
3,300	332						
3,900	392						
4,700	472						
5,100	512						
5,600	562						
6,800	682						
8,200	822						
10,000	103						

Special values, tolerances, higher WV_{DC} and matching available, please consult factory.

EXXELIA Components Portfolio





Headquarters

93, rue Oberkampf
75011 PARIS • FRANCE
Tel.: +33 1 49 23 10 00
www.exxelia.com

AMERICAS

North America

1221 N. Highway 17-92,
Longwood, FL 32750 • USA
Tel.: +1 407 695-6562
sales.america@exxelia.com

EUROPE

Western Europe

93, rue Oberkampf
75011 PARIS • FRANCE
Tel.: +33 1 49 23 10 00
sales.france@exxelia.com

Northern Europe

Cylindervägen 18
SE-131 52 Nacka Strand • SWEDEN
Tel.: +46 76 16 50 014
sales.world@exxelia.com

APAC

India

Level 7, Mfar Greenheart
Manyata Tech Park
Outer Ring Road, Hebbal,
BANGALORE - 560045
Tel.: +91 80 67 65 41 14
sales.world@exxelia.com

China

Mayfair Tower NO.83
Fu Min Road - 200040 Shanghai • CHINA
Tel.: +86 21 6132 7197
sales.world@exxelia.com



Headquarters

93, rue Oberkampf

75011 PARIS • FRANCE

Tel. : +33 (0)1 49 23 10 00

www.exxelia.com

